



# Athletic Connection

TEAM SPORTS - STRENGTH & FITNESS - FACILITIES - P.E.



2022 FALL CATALOG

# BRANDS YOU DEMAND

**GEAR**  
PRO-TEC

**US Games**

**igloo**

**SPALDING**

**ALUMIGOAL**

**Alleson**  
ATHLETIC

**Majestic**

**GAMECRAFT**

**CHAMPION**  
BARBELL

**DeMARINI**

**Mizuno**

**DUDLEY**

**GSC**

**Fitnex**

**Harrow**

**shield**

**GRIZZLY**

**DIAMOND**  
PRO

**RolDri**

**Báden**  
PASSION FOR A BETTER GAME

**LOUISVILLE**  
SLUGGER

**LOUISVILLE**  
SLUGGER

**Rawlings**

**Z-COOL**

**EKHO**

**MARKERS, INC.**  
Quality Products at Reasonable Prices

**Wilson**

**EASTON**

**BRINE**

**MIKASA**  
SPORTS  
USA

**Diamond**

**TITAN**

**MARK 1**

**WORTH**

**PUNNERS**

**DUNLOP**

**deBeer**  
LACROSSE

**carlton**

**PRO-LINE**

**ALL-STAR**

**BOW**  
NET

**STX**  
LACROSSE

**MacGregor**

**Voit**

**REACTOR**  
BY CHAMPION BARBELL

**GILL**  
ATHLETICS

**MAVERIK**  
LACROSSE

**PRO-DOWN**

**GoldMedal**  
ATHLETIC PRODUCTS

**SPORTS**  
COOL

**TRIPLE**  
THREAT

**PORTaPIT**

**schutt**

**HEAD**

**FLAGTAG**

**TACHIKARA**

**ACCUSPLIT**

**SKLZ**

**ULTRAK**

**penn**

**Framer**

**FOUNDED**  
**EDWARDS**  
1911  
SPORTS PRODUCTS LTD

**OC**

**FISHER**

**Bison**

**SELECT**  
player's choice

## TEAM SPORTS

<b>BENCHES &amp; BLEACHERS</b>	<b>004 - 011</b>
<b>PARKS</b>	<b>012 - 015</b>
<b>BASEBALL / SOFTBALL</b>	<b>016 - 081</b>
Backstops & Cages	<b>016 - 022</b>
Batting Tunnels	<b>023 - 025</b>
Protective Screens	<b>026 - 027</b>
Windscreen	<b>028 - 029</b>
Field Accessories	<b>030 - 039</b>
Field Maintenance	<b>040 - 047</b>
Bases	<b>048 - 053</b>
Pitching Machines & Mounds	<b>054 - 055</b>
Baseballs & Softballs	<b>056 - 069</b>
Training Aids	<b>070 - 071</b>
Bags	<b>072 - 073</b>
Catcher's Gear & Gloves/Mitts	<b>074 - 076</b>
Scorebooks & Umpire Equipment	<b>077 - 079</b>
MLB Replica	<b>080 - 081</b>
<b>BASKETBALL</b>	<b>082 - 101</b>
Basketballs	<b>082 - 087</b>
Backboards, Goals & Systems	<b>088 - 096</b>
Accessories	<b>097 - 101</b>
<b>FOOTBALL</b>	<b>102 - 133</b>
Footballs	<b>102 - 103</b>
Tackling & Training Aids	<b>104 - 108</b>
Field Accessories	<b>109 - 113</b>
Shoulder Pads & Girdles	<b>114 - 129</b>
Football Accessories	<b>130 - 131</b>
Flag Football Belts & Accessories	<b>132 - 133</b>
<b>HYDRATION</b>	<b>134 - 135</b>
<b>LACROSSE</b>	<b>136 - 149</b>
<b>SPORTS MEDICINE</b>	<b>140 - 143</b>
<b>SOCCER</b>	<b>144 - 161</b>
Balls	<b>144 - 147</b>
Goals & Nets	<b>148 - 154</b>
Accessories	<b>155 - 161</b>
<b>RACQUET SPORTS</b>	<b>162 - 177</b>
Tennis Post & Nets	<b>162 - 163</b>
Rol Dri / Tennis Accessories	<b>164</b>
Scorekeepers / Storage / Tidi-Court	<b>165 - 169</b>

Balls & Racquets	<b>170 - 171</b>
Badminton & Racquet Ball	<b>172 - 175</b>
Pickle Ball	<b>176 - 177</b>

<b>TRACK &amp; FIELD</b>	<b>178 - 197</b>
Pit & Pit Accessories	<b>178 - 185</b>
Hurdles & Starting Blocks	<b>186 - 189</b>
Discus & Shots	<b>190 - 191</b>
Track Accessories	<b>192 - 197</b>

<b>VOLLEYBALL</b>	<b>198 - 210</b>
Balls	<b>198 - 202</b>
Storage & Score Keepers	<b>203</b>
Systems	<b>204 - 207</b>
Nets & Accessories	<b>208 - 210</b>
<b>WRESTLING MATS</b>	<b>211</b>

## STRENGTH & FITNESS

<b>WEIGHT LIFTING EQUIPMENT</b>	<b>212 - 226</b>
<b>CARDIO</b>	<b>227 - 233</b>
Bikes, Treadmills, Gym Flooring	<b>227 - 234</b>
Kettlebells & Medicine Balls	<b>235 - 237</b>
Bands / Chinning / Fitness Balls	<b>238 - 240</b>
Mats / Rollers / BOSU	<b>241 - 243</b>
Plyo Boxes / Jump Ropes / Accessories	<b>244 - 245</b>
<b>SPEED &amp; AGILITY</b>	<b>246 - 247</b>
<b>ASSESSMENT</b>	<b>248 - 249</b>
<b>WALL PADS</b>	<b>250 - 251</b>
<b>FLOOR COVERS</b>	<b>252</b>
<b>GYM MATS</b>	<b>253 - 255</b>
<b>COACHING &amp; INFLATORS</b>	<b>256 - 257</b>

## FACILITY

<b>SCOREBOARDS</b>	<b>258 - 259</b>
<b>STORAGE</b>	<b>260 - 263</b>
<b>GAME TABLES &amp; BOARD GAMES</b>	<b>264 - 267</b>

## PHYSICAL EDUCATION

Playground Balls & Value Packs	<b>268 - 269</b>
Cones / Hoops / Jump Ropes / Scooters	<b>270 - 271</b>
Lawn Games	<b>272 - 273</b>
Archery	<b>274 - 276</b>



15' ANODIZED ALUMINUM



15' NAVY BLUE

### PLAYER'S BENCH WITH SHELF

- Finally, players and coaches have a place for equipment
- Features 10"W anodized or powder coated planks
- 20"W rear shelf
- All aluminum construction.
- Portable or surface mount (requires drilling holes in framework)

**5 Year Limited Warranty**

ANODIZED ALUMINUM		
LENGTH	CODE	PRICE
7.5'	<b>BEPS08</b>	\$999 <sup>99</sup> ★
15'	<b>BEPS15</b>	\$1,699 <sup>99</sup> ★
21'	<b>BEPS21</b>	\$1,999 <sup>99</sup> ★
27'	<b>BEPS27</b>	\$2,699 <sup>99</sup> ★
POWDER-COATED (SELECT COLOR)		
7.5'	<b>BEPS08C</b>	\$1,199 <sup>99</sup> ★
15'	<b>BEPS15C</b>	\$1,799 <sup>99</sup> ★
21'	<b>BEPS21C</b>	\$2,299 <sup>99</sup> ★



Shelf space allows place for helmets, scorebooks, caps, water bottles, gloves, etc.



FOREST GREEN

### SCORERS TABLE WITH BENCH

- Table and bench are 7.5' L
- All aluminum construction
- Features 10"W anodized or powder coated aluminum seat planks
- 20"W ribbed aluminum table top.
- If choosing powder coated, specify color: Forest Green, Navy Blue, Red, Royal Blue

**5 Year Limited Warranty**

<b>BEST08</b>	Natural Aluminum	\$999 <sup>99</sup> EA ★
<b>BEST08C</b>	Powder Coated	\$1,099 <sup>99</sup> EA ★



ALUMINUM

NAVY BLUE

SCARLET RED

ROYAL BLUE



### 5' COURTSIDE BENCH

- Heavy duty aluminum bench with back
- 2 3/8" OD galvanized steel legs
- Planks are powder coated and come with safety end caps

**5 Year Limited Warranty**

<b>BEPG05G</b>	Forest Green	\$799 <sup>99</sup> EA ★
<b>BEPG05W</b>	White	\$799 <sup>99</sup> EA ★



### SAFETY END CAPS

- UV treated poly endcaps
- No Sharp edges
- Designed to fit BSN Sports planks only
- Sold in pack of 6
- Hardware included

**ZENDCAP** \$44<sup>99</sup> PACK ★



### GYM FLOOR PROTECTOR KIT

- Non-marring floor protectors
- Fit any 2 3/8" O.D. material

**5 Year Limited Warranty**

<b>BEPROT8</b>	7 1/2" Bench kit	\$21 <sup>99</sup> KIT OF 4
<b>BEPROT15</b>	15" Bench kit	\$29 <sup>99</sup> KIT OF 6

**ADD COLOR TO YOUR BENCHES!**

SPECIFY COLOR WHEN ORDERING



## PLAYER'S BENCH WITH BACK

THE BEST PLAYER'S BENCHES AVAILABLE...GUARANTEED!

- Seat planks are 10" wide with a ribbed no-slip surface.
- Planks are anodized aluminum and will not rub off on clothing
- Comes with Safety End Caps -No sharp edges to snag clothing or skin
- Legs are constructed of heavy duty commercial grade 2-3/8" O.D. galvanized steel
- Portable models are designed for indoor and outdoor use and come complete with non-marring floor protectors



5 Year Limited Warranty

ANODIZED ALUMINUM				
	IN-GROUND	PORTABLE	SURFACE-MOUNT	
LENGTH	CODE	CODE	CODE	PRICE
7.5'	<b>BEPB08</b>	<b>BEPG08</b>	<b>BEPH08</b>	\$799 <sup>99</sup> ★
15'	<b>BEPB15</b>	<b>BEPG15</b>	<b>BEPH15</b>	\$999 <sup>99</sup> ★
21'	<b>BEPB21</b>	<b>BEPG21</b>	<b>BEPH21</b>	\$1,299 <sup>99</sup> ★
27'	<b>BEPB27</b>	<b>BEPG27</b>	<b>BEPH27</b>	\$1,499 <sup>99</sup> ★

POWDER-COATED (SELECT COLOR)				
	IN-GROUND	PORTABLE	SURFACE-MOUNT	
LENGTH	CODE	CODE	CODE	PRICE
7.5'	<b>BEPB08C</b>	<b>BEPG08C</b>	<b>BEPH08C</b>	\$899 <sup>99</sup> ★
15'	<b>BEPB15C</b>	<b>BEPG15C</b>	<b>BEPH15C</b>	\$1,299 <sup>99</sup> ★
21'	<b>BEPB21C</b>	<b>BEPG21C</b>	<b>BEPH21C</b>	\$1,399 <sup>99</sup> ★

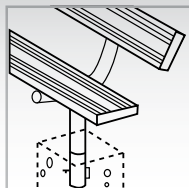
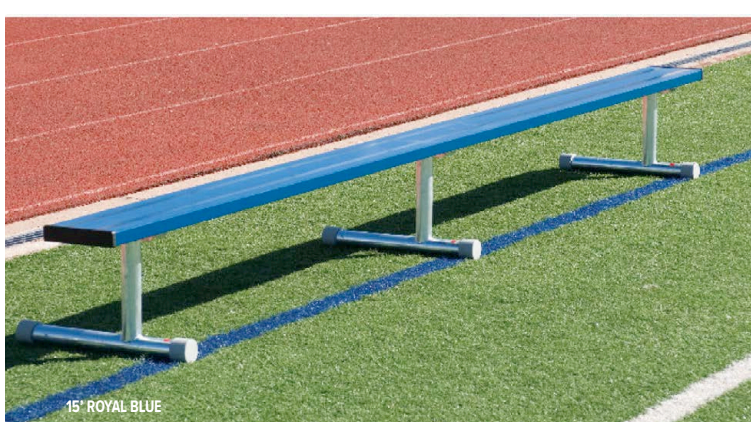
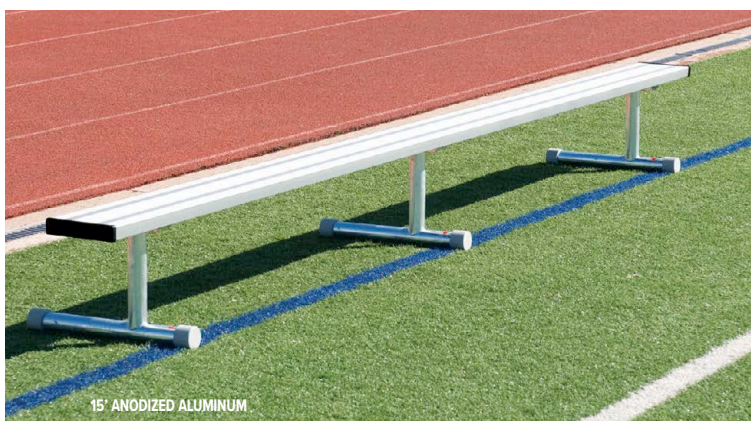
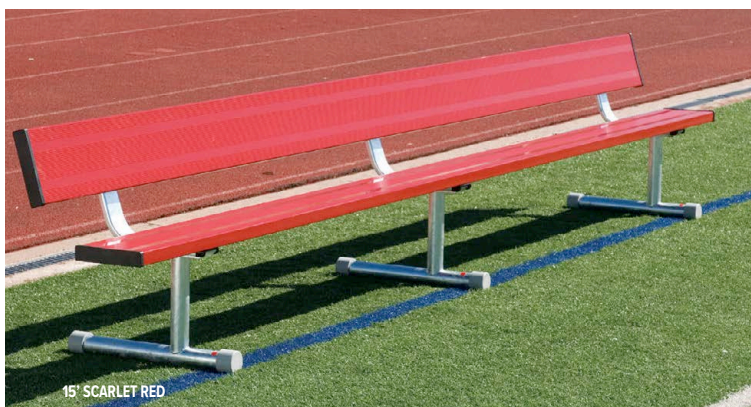
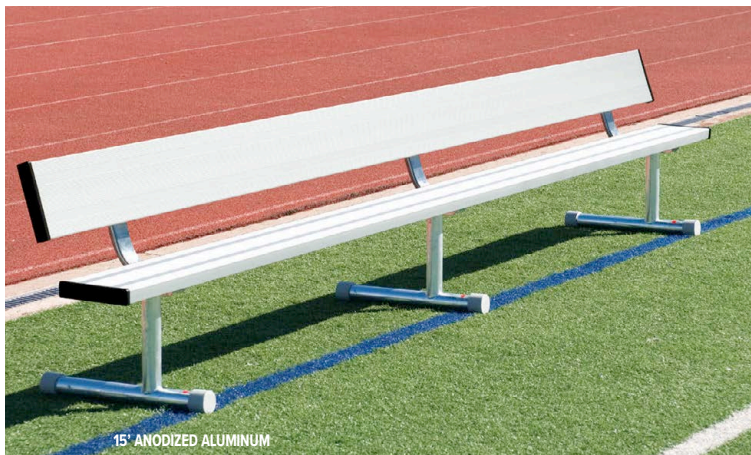

IN-GROUND

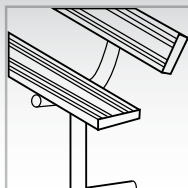

PORTABLE

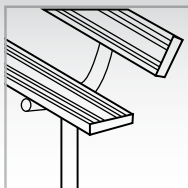

SURFACE-MOUNT

## PLAYER'S BENCH WITHOUT BACK

• Same features as listed above - simply sold without the back rest

5 Year Limited Warranty



ANODIZED ALUMINUM				
	IN-GROUND	PORTABLE	SURFACE-MOUNT	
LENGTH	CODE	CODE	CODE	PRICE
7.5'	<b>BEPD08</b>	<b>BEPI08</b>	<b>BEPE08</b>	\$599 <sup>99</sup> ★
15'	<b>BEPD15</b>	<b>BEPI15</b>	<b>BEPE15</b>	\$799 <sup>99</sup> ★
21'	<b>BEPD21</b>	<b>BEPI21</b>	<b>BEPE21</b>	\$899 <sup>99</sup> ★
27'	<b>BEPD27</b>	N/A	<b>BEPE27</b>	\$1,299 <sup>99</sup> ★

POWDER-COATED (SELECT COLOR)				
	IN-GROUND	PORTABLE	SURFACE-MOUNT	
LENGTH	CODE	CODE	CODE	PRICE
7.5'	<b>BEPD08C</b>	<b>BEPI08C</b>	<b>BEPE08C</b>	\$699 <sup>99</sup> ★
15'	<b>BEPD15C</b>	<b>BEPI15C</b>	<b>BEPE15C</b>	\$899 <sup>99</sup> ★
21'	<b>BEPD21C</b>	<b>BEPI21C</b>	<b>BEPE21C</b>	\$1,099 <sup>99</sup> ★



**CALL FOR DISCOUNTED PRICING ON BULK ORDERS**



PREFERRED, 15' FOREST GREEN

NOTE: Bleachers are shipped knocked down.

### LOW RISE BLEACHERS

- Specially designed frames that allows 4 rows of seating without the need for safety fencing.
- Frames are 100% welded aluminum angle
- First row has a seat height of 12"
- Top row has a seat height of 29"
- Seat planks are anodized aluminum or powder coated and won't rub off on clothes!
- Standard models include single foot planks
- Preferred models include double foot planks
- Due to constantly changing specifications, Please check local building and safety codes to ensure bleacher compliance.



5 Year Limited Warranty



STANDARD - Single Foot Planks



PREFERRED - Double Foot Planks

ANODIZED ALUMINUM 								
ROWS	LXHXD	SEATS	STANDARD	PREFERRED	STANDARD	PRICE	PREFERRED	PRICE
4	7.5'x30"x81"	20	155 lbs	200 lbs	LR0408	\$2,499 <sup>99</sup> ★	LR0408P	\$2,999 <sup>99</sup> ★
4	15'x30"x81"	40	270 lbs	355 lbs	LR0415	\$3,299 <sup>99</sup> ★	LR0415P	\$3,699 <sup>99</sup> ★
4	21'x30"x81"	56	385 lbs	500 lbs	LR0421	\$4,199 <sup>99</sup> ★	LR0421P	\$4,499 <sup>99</sup> ★
4	27'x30"x81"	72	500 lbs	665 lbs	LR0427	\$4,599 <sup>99</sup> ★	LR0427P	\$5,499 <sup>99</sup> ★
POWDER-COATED (SELECT COLOR) 								
ROWS	LXHXD	SEATS	STANDARD	PREFERRED	STANDARD	PRICE	PREFERRED	PRICE
4	7.5'x30"x81"	20	155 lbs	200 lbs	LR0408C	\$2,699 <sup>99</sup> ★	LR0408CP	\$3,299 <sup>99</sup> ★
4	15'x30"x81"	40	270 lbs	355 lbs	LR0415C	\$3,499 <sup>99</sup> ★	LR0415CP	\$3,999 <sup>99</sup> ★
4	21'x30"x81"	56	385 lbs	500 lbs	LR0421C	\$4,399 <sup>99</sup> ★	LR0421CP	\$4,699 <sup>99</sup> ★

We build our benches & bleachers to the highest standards. Listed below are some of the differences by others who may be listing their benches & bleachers as comparable to ours.

1. Frames - Ours are 100% aluminum angle. Be careful of those quoting "galvanized, steel angle iron" as equal.
2. Seat Planks - Ours are 100% anodized aluminum with a minimum wall thickness of .078 in. A thinner walled unit does not have the strength or support.
3. End Caps - Ours are constructed of fiber reinforced polypropylene. No sharp edges to snag clothing or skin.

4. Indoor Use - Our Tip N' Roll units come with rubber leg protectors so they can be used indoors or out. Be careful of those units using steel vs aluminum. In a "tip-over" fashion, steel could damage your gym floor or cause personal injuries.

Don't be fooled by a low price. Our manufacturing team has been in this business for 30 years. If you see bids or quotes that "seem too good to be true" - they are. Respectable manufacturers purchase aluminum at the same prices. Anyone offering to deliver product at 30% less is not matching specs.

**ADD COLOR TO YOUR BLEACHERS!**

SPECIFY COLOR WHEN ORDERING





NOTE: Bleachers are shipped knocked down.

STANDARD 3 ROW,  
15' ANODIZED ALUMINUM



PREFERRED 2 ROW, 15' ROYAL BLUE



PREFERRED 3 ROW, 15' SCARLET

### BLEACHERS WITHOUT FENCING

- Frames are 100% welded aluminum angle
- First row has a seat height of 18"
- Top row has a seat height of 29"
- Planks are 10"W
- Due to constantly changing specifications, please check local building and safety codes to ensure bleacher compliance
- Standard models include single foot planks
- Preferred models include double foot planks

5 Year Limited Warranty



STANDARD - Single Foot Planks



PREFERRED - Double Foot Planks

#### ANODIZED ALUMINUM

ROWS	LXHXD	SEATS	STANDARD	PREFERRED	STANDARD	PRICE	PREFERRED	PRICE
2	15'x24"x36"	20	126 lbs	157 lbs	NB0215	\$2,199 <sup>99</sup> ★	NB0215P	\$2,699 <sup>99</sup> ★
2	21'x24"x36"	28	170 lbs	213 lbs	NB0221	\$2,599 <sup>99</sup> ★	NB0221P	\$2,799 <sup>99</sup> ★
3	15'x30"x60"	30	203 lbs	263 lbs	NB0315	\$2,899 <sup>99</sup> ★	NB0315P	\$3,199 <sup>99</sup> ★
3	21'x30"x60"	42	280 lbs	360 lbs	NB0321	\$3,199 <sup>99</sup> ★	NB0321P	\$3,399 <sup>99</sup> ★
3	27'x30"x60"	54	367 lbs	476 lbs	NB0327	\$3,799 <sup>99</sup> ★	NB0327P	\$3,999 <sup>99</sup> ★

#### POWDER-COATED (SELECT COLOR)

ROWS	LXHXD	SEATS	STANDARD	PREFERRED	STANDARD	PRICE	PREFERRED	PRICE
2	15'x24"x36"	20	126 lbs	157 lbs	NB0215C	\$2,499 <sup>99</sup> ★	NB0215CP	\$2,699 <sup>99</sup> ★
2	21'x24"x36"	28	170 lbs	213 lbs	NB0221C	\$2,899 <sup>99</sup> ★	NB0221CP	\$2,999 <sup>99</sup> ★
3	15'x30"x60"	30	203 lbs	263 lbs	NB0315C	\$2,999 <sup>99</sup> ★	NB0315CP	\$3,199 <sup>99</sup> ★
3	21'x30"x60"	42	280 lbs	360 lbs	NB0321C	\$3,499 <sup>99</sup> ★	NB0321CP	\$3,699 <sup>99</sup> ★



**CALL FOR DISCOUNTED PRICING  
ON BULK ORDERS**



STANDARD - Single Foot Planks



NOTE: Bleachers are shipped knocked down.

### BLEACHERS WITH FENCING

- Frames are 100% welded aluminum angle
- Planks are 10" W
- Seat planks are anodized aluminum or powder coated and won't rub off on clothes
- Bleachers include guardrail system and riser boards on rows 4 and above
- Colored bleachers include colored seat planks only
- Planks include safety end caps - no sharp edges to snag clothes or skin
- Due to constantly changing specifications, please check local building and safety codes to ensure compliance

5 Year Limited Warranty

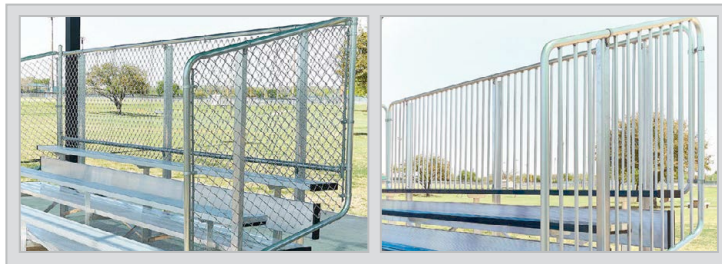

#### ANODIZED ALUMINUM

ROWS	LENGTH	SEATS	WEIGHT	CHAIN-LINK	PRICE	VERTICAL PICKET	PRICE
4	15'	40	596 lbs	<b>NB0415</b>	\$4,999 <sup>99</sup> ★	<b>NB0415V</b>	\$5,999 <sup>99</sup> ★
4	21'	56	777 lbs	<b>NB0421</b>	\$5,899 <sup>99</sup> ★	<b>NB0421V</b>	\$6,899 <sup>99</sup> ★
4	27'	72	970 lbs	<b>NB0427</b>	\$6,499 <sup>99</sup> ★	<b>NB0427V</b>	\$7,999 <sup>99</sup> ★
5	15'	50	749 lbs	<b>NB0515</b>	\$5,899 <sup>99</sup> ★	<b>NB0515V</b>	\$6,899 <sup>99</sup> ★
5	21'	70	992 lbs	<b>NB0521</b>	\$7,299 <sup>99</sup> ★	<b>NB0521V</b>	\$8,999 <sup>99</sup> ★
5	27'	90	1250 lbs	<b>NB0527</b>	\$8,999 <sup>99</sup> ★	<b>NB0527V</b>	\$10,999 <sup>99</sup> ★

#### POWDER-COATED (SELECT COLOR)

ROWS	LENGTH	SEATS	WEIGHT	CHAIN-LINK	PRICE	VERTICAL PICKET	PRICE
4	15'	40	596 lbs	<b>NB0415C</b>	\$5,299 <sup>99</sup> ★	<b>NB0415CV</b>	\$6,299 <sup>99</sup> ★
4	21'	56	777 lbs	<b>NB0421C</b>	\$6,199 <sup>99</sup> ★	<b>NB0421CV</b>	\$7,199 <sup>99</sup> ★
5	15'	50	749 lbs	<b>NB0515C</b>	\$6,299 <sup>99</sup> ★	<b>NB0515CV</b>	\$7,299 <sup>99</sup> ★
5	21'	70	992 lbs	<b>NB0521C</b>	\$7,899 <sup>99</sup> ★	<b>NB0521CV</b>	\$9,199 <sup>99</sup> ★

**ADD COLOR TO YOUR BLEACHERS!**

SPECIFY COLOR WHEN ORDERING







4 ROW, 15' SCARLET RED WITH VERTICAL PICKETS



PREFERRED - Double Foot Planks



NOTE: Bleachers are shipped knocked down.

### PREFERRED BLEACHERS WITH FENCING

- Frames are 100% welded aluminum angle
- Seat planks are anodized or powder coated (where applicable)
- Bleachers include guardrail system and riser boards on rows 4 and above
- Chain-link fencing is 9 gauge steel
- Available in 4 & 5 row models
- Available in 15', 21' and 27' long
- Due to constantly changing specifications, please check local building and safety codes to ensure compliance.

5 Year Limited Warranty

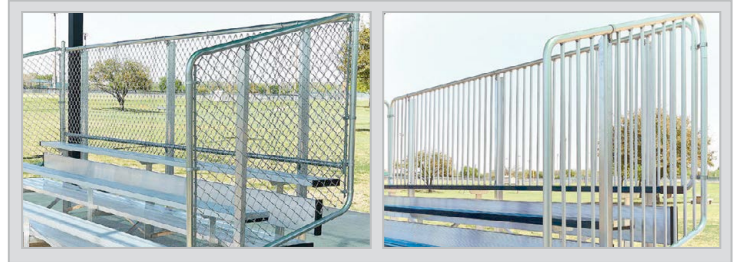

#### ANODIZED ALUMINUM

ROWS	LENGTH	SEATS	WEIGHT	CHAIN-LINK	PRICE	VERTICAL PICKET	PRICE
4	15'	40	616 lbs	<b>NB0415P</b>	\$5,499 <sup>99</sup> ★	<b>NB0415VP</b>	\$6,499 <sup>99</sup> ★
4	21'	56	820 lbs	<b>NB0421P</b>	\$6,299 <sup>99</sup> ★	<b>NB0421VP</b>	\$7,999 <sup>99</sup> ★
4	27'	72	1038 lbs	<b>NB0427P</b>	\$9,999 <sup>99</sup> ★	<b>NB0427VP</b>	\$11,999 <sup>99</sup> ★
5	15'	50	769 lbs	<b>NB0515P</b>	\$6,299 <sup>99</sup> ★	<b>NB0515VP</b>	\$7,499 <sup>99</sup> ★
5	21'	70	1032 lbs	<b>NB0521P</b>	\$7,899 <sup>99</sup> ★	<b>NB0521VP</b>	\$8,999 <sup>99</sup> ★
5	27'	90	1316 lbs	<b>NB0527P</b>	\$10,999 <sup>99</sup> ★	<b>NB0527VP</b>	\$12,999 <sup>99</sup> ★

#### POWDER-COATED (SELECT COLOR)

ROWS	LENGTH	SEATS	WEIGHT	CHAIN-LINK	PRICE	VERTICAL PICKET	PRICE
4	15'	40	616 lbs	<b>NB0415CP</b>	\$6,199 <sup>99</sup> ★	<b>NB0415CVP</b>	\$7,199 <sup>99</sup> ★
4	21'	56	820 lbs	<b>NB0421CP</b>	\$6,499 <sup>99</sup> ★	<b>NB0421CVP</b>	\$8,199 <sup>99</sup> ★
5	15'	50	769 lbs	<b>NB0515CP</b>	\$6,899 <sup>99</sup> ★	<b>NB0515CVP</b>	\$7,799 <sup>99</sup> ★
5	21'	70	1032 lbs	<b>NB0521CP</b>	\$8,199 <sup>99</sup> ★	<b>NB0521CVP</b>	\$9,199 <sup>99</sup> ★

FOREST GREEN

ROYAL BLUE

**CALL FOR DISCOUNTED PRICING  
ON BULK ORDERS**



## TIP N' ROLL BLEACHERS

- Tip N' Roll bleachers are perfect for auxiliary seating requirements
- Unit easily tips up on its casters for convenient storage
- Frames are 100% welded aluminum angle
- Seat planks are either anodized or powder coated (where applicable)
- High grade swivel casters & rubber foot pads will not mar your floors
- Due to constantly changing specifications, please check local building and safety codes to ensure compliance
- Standard models include single foot planks
- Preferred models include double foot planks
- WARNING: These lightweight units are easily tipped up for rolling by any responsible adult. However, if tipped up outdoors, extreme caution should be taken in windy conditions. Multiple adults may be required to control the unit

5 Year Limited Warranty



STANDARD - Single Foot Planks

PREFERRED - Double Foot Planks

ANODIZED ALUMINUM								
ROWS	LXHXD	SEATS	STANDARD	PREFERRED	STANDARD	PRICE	PREFERRED	PRICE
2	7.5'x24"x36"	10	72 lbs	89 lbs	TR0208	\$1,989 <sup>99</sup> ★	TR0208P	\$2,089 <sup>99</sup> ★
2	15'x24"x36"	20	131 lbs	162 lbs	TR0215	\$2,399 <sup>99</sup> ★	TR0215P	\$2,589 <sup>99</sup> ★
2	21'x24"x36"	28	175 lbs	219 lbs	TR0221	\$2,889 <sup>99</sup> ★	TR0221P	\$3,099 <sup>99</sup> ★
3	7.5'x30"x60"	15	116 lbs	133 lbs	TR0308	\$2,399 <sup>99</sup> ★	TR0308P	\$2,489 <sup>99</sup> ★
3	15'x30"x60"	30	207 lbs	252 lbs	TR0315	\$2,599 <sup>99</sup> ★	TR0315P	\$2,999 <sup>99</sup> ★
3	21'x30"x60"	42	265 lbs	345 lbs	TR0321	\$3,299 <sup>99</sup> ★	TR0321P	\$3,699 <sup>99</sup> ★
3	27'x30"x60"	54	352 lbs	N/A	TR0327	\$3,899 <sup>99</sup> ★	N/A	N/A
4*	7.5'x30"x81"	20	146 lbs	190 lbs	TR0408	\$2,799 <sup>99</sup> ★	TR0408P	\$3,199 <sup>99</sup> ★
4*	15'x30"x81"	40	295 lbs	384 lbs	TR0415	\$3,499 <sup>99</sup> ★	TR0415P	\$3,899 <sup>99</sup> ★
4*	21'x30"x81"	56	398 lbs	524 lbs	TR0421	\$3,999 <sup>99</sup> ★	TR0421P	\$4,499 <sup>99</sup> ★
POWDER-COATED  - SELECT YOUR COLOR								
ROWS	LENGTH	SEATS	STANDARD	PREFERRED	STANDARD	PRICE	PREFERRED	PRICE
2	7.5'x24"x36"	10	72 lbs	89 lbs	TR0208C	\$1,999 <sup>99</sup> ★	TR0208CP	\$2,099 <sup>99</sup> ★
2	15'x24"x36"	20	131 lbs	162 lbs	TR0215C	\$2,499 <sup>99</sup> ★	TR0215CP	\$2,599 <sup>99</sup> ★
2	21'x24"x36"	28	175 lbs	219 lbs	TR0221C	\$2,899 <sup>99</sup> ★	TR0221CP	\$3,399 <sup>99</sup> ★
3	7.5'x30"x60"	15	116 lbs	133 lbs	TR0308C	\$2,499 <sup>99</sup> ★	TR0308CP	\$2,599 <sup>99</sup> ★
3	15'x30"x60"	30	207 lbs	252 lbs	TR0315C	\$2,899 <sup>99</sup> ★	TR0315CP	\$3,299 <sup>99</sup> ★
3	21'x30"x60"	42	265 lbs	345 lbs	TR0321C	\$3,499 <sup>99</sup> ★	TR0321CP	\$3,799 <sup>99</sup> ★
4*	7.5'x30"x81"	20	146 lbs	190 lbs	TR0408C	\$2,899 <sup>99</sup> ★	TR0408CP	\$3,399 <sup>99</sup> ★
4*	15'x30"x81"	40	295 lbs	384 lbs	TR0415C	\$3,599 <sup>99</sup> ★	TR0415CP	\$4,099 <sup>99</sup> ★
4*	21'x30"x81"	56	398 lbs	524 lbs	TR0421C	\$4,299 <sup>99</sup> ★	TR0421CP	\$4,699 <sup>99</sup> ★

\*4 Row models feature low rise framework. See page 6 for full details.

**ADD COLOR TO YOUR  
TIP N' ROLL BLEACHERS!**  
SPECIFY COLOR WHEN ORDERING



**CALL FOR DISCOUNTED PRICING ON BULK ORDERS!**



PLEASE ALLOW 3 TO 4 WEEKS FOR DELIVERY.

### VIP SERIES BLEACHERS

- Frames are 100% welded aluminum angle
- 2" x 10" anodized aluminum seat planks
- 2 - 2" x 10" foot planks on every row
- 2" x 10" riser on top row and 1" x 6" risers on all other rows
- 2" 9 gauge fence railing on all chain-link models
- 4.5' aisle with aluminum hand rail on select models

**5 Year Limited Warranty**

ROWS	LENGTH	SEATS	RAILING	AISLE	CHAIN-LINK	VERTICAL PICKET
5	21'	58	✓	✓	1049185 \$13,999 <sup>99</sup>	1196542 \$22,999 <sup>99</sup>
8	15'	80	✓		1135190 \$16,999 <sup>99</sup>	1196559 \$22,899 <sup>99</sup>
8	21'	112	✓		1135206 \$20,699 <sup>99</sup>	1196566 \$27,899 <sup>99</sup>
8	21'	91	✓	✓	1135220 \$25,499 <sup>99</sup>	1196580 \$29,999 <sup>99</sup>
8	27'	144	✓		1135213 \$27,999 <sup>99</sup>	1196573 \$33,899 <sup>99</sup>
8	27'	116	✓	✓	1135237 \$29,999 <sup>99</sup>	1196597 \$39,999 <sup>99</sup>
10	15'	100	✓		1135244 \$20,899 <sup>99</sup>	1196603 \$24,699 <sup>99</sup>
10	21'	140	✓		1135251 \$27,399 <sup>99</sup>	1196610 \$29,899 <sup>99</sup>
10	21'	113	✓	✓	1135275 \$29,699 <sup>99</sup>	1196634 \$34,499 <sup>99</sup>
10	27'	180	✓		1135268 \$33,999 <sup>99</sup>	1196627 \$38,299 <sup>99</sup>
10	27'	144	✓	✓	1135282 \$35,999 <sup>99</sup>	1196641 \$45,499 <sup>99</sup>

### TRANSPORTABLE PREFERRED BLEACHERS

- Designed to be moved around your grounds (5 mph max)
  - Each transportable bleacher is fitted with a galvanized steel horizontal lifting brace, and has extra bracing to stabilize the bleacher during transport.
  - Transportable bleachers come with ground sills and require the purchase of one transport kit which can move several bleachers, one at a time
  - Both Preferred and Deluxe Bleachers feature double foot planks on all rows w/single seat planks, riser closure on rows 4 and up with chain-link guardrail starting at row 3.
  - Deluxe Bleachers also include the added benefit of a handrail
- 5 Year Limited Warranty**



#### PREFERRED DESIGN BLEACHERS

ROWS	LENGTH	SEATS	WEIGHT	CODE	PRICE
5	15'	50	1028 lbs	NBT0515P	\$12,999 <sup>99</sup>
5	21'	70	1446 lbs	NBT0521P	\$13,799 <sup>99</sup>
5	24'	80	1559 lbs	NBT0524P	\$15,999 <sup>99</sup>
10	15'	100	2161 lbs	NBT1015P	\$20,999 <sup>99</sup>
10	21'	140	3068 lbs	NBT1021P	\$29,799 <sup>99</sup>
10	24'	160	3285 lbs	NBT1024P	\$32,099 <sup>99</sup>

#### DELUXE DESIGN BLEACHERS

ROWS	LENGTH	SEATS	WEIGHT	CODE	PRICE
5	21'	58	1519 lbs	NBT0521D	\$15,499 <sup>99</sup>
5	24'	68	1641 lbs	NBT0524D	\$16,999 <sup>99</sup>
10	21'	113	3193 lbs	NBT1021D	\$36,199 <sup>99</sup>
10	24'	133	3422 lbs	NBT1024D	\$36,299 <sup>99</sup>

**MADE IN USA**



### TRANSPORT KIT (REQUIRED)

5 Year Limited Warranty

NBTK5  
NBTK10

5 Row Transport Kit - Required with 5 row Transportable Bleachers  
10 Row Transport Kit - Required with 10 Row Transportable Bleachers

\$3,999<sup>99</sup> EA   
\$7,799<sup>99</sup> EA

## HEAVY DUTY RECTANGULAR TABLE

- 6', 8', 10' and 12' lengths available
- 2-3/8" diameter all welded frame with powder coat finish
- Diamond and Perforated patterns available
- 1 or 2 sided ADA 8' versions
- Table is both Portable and Surface Mount (mounting hardware not included)

5 Year Limited Warranty



WIDE WALK THROUGH DESIGN FOR EASY ENTRY & EXIT



SIZE	STYLE	DIAMOND	PERFORATED	PRICE EA.	DELIVERY
6'	Walk-thru	1275353	1275360	\$2,099 <sup>99</sup>	
8'	Walk-thru	1275377	1275384	\$2,299 <sup>99</sup>	
8' ADA	Double sided	1275438	1275445	\$2,057 <sup>99</sup>	
8' ADA	Single sided	1275452	1275469	\$2,048 <sup>99</sup>	
10'	Walk-thru	1275391	1275407	\$2,775 <sup>99</sup>	
12'	Walk-thru	1275414	1275421	\$2,893 <sup>99</sup>	

## THE THERMOPLASTIC ADVANTAGE!

- High thermal stability keeps seats and tables cooler
- More corrosion and rust-resistant than other coatings
- Products are more durable and last longer
- FDA approved non-stick surface confidence in user safety for food contact



### 46" SQUARE AND ROUND TABLES

- 1-5/8" diameter steel frame with powder coat finish
- Diamond and Perforated patterns available
- Portable and/or Surface Mount (mounting hardware not included)
- Includes center umbrella hole

5 Year Limited Warranty



Square

SIZE	STYLE	DIAMOND	PERFORATED	PRICE EA.	DELIVERY
46"	Square	1275476	1275483	\$2,099 <sup>99</sup>	
46"	Round	1275490	1275506	\$2,199 <sup>99</sup>	



### RECTANGULAR PEDESTAL TABLE

- 4' and 6' lengths available
- Heavy-duty 4" square steel center post
- 3" square steel support arm posts
- Diamond and Perforated patterns available
- In-Ground or Surface Mount
- ADA compliant

5 Year Limited Warranty



In-Ground

SIZE	PATTERN	IN-GROUND	SURFACE MOUNT	PRICE EA.	DELIVERY
4'	Diamond	1275513	1275520	\$2,857 <sup>99</sup>	
4'	Perforated	1275537	1275544	\$3,061 <sup>99</sup>	
6'	Diamond	1275551	1275568	\$3,125 <sup>99</sup>	
6'	Perforated	1275575	1275582	\$3,274 <sup>99</sup>	

## THERMOPLASTIC & POWDER COAT COLOR OPTIONS:

Tables, benches & receptacles feature rounded corners with either diamond expanded or perforated pattern. All items can be coated with any color shown here.

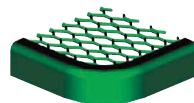

DIAMOND EXPANDED

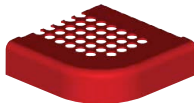



PERFORATED

- BLACK
- BROWN
- GREEN
- DARK BLUE
- BURGANDY
- BLUE
- RED
- BEIGE



## HEAVY DUTY PICNIC TABLES

- 6' and 8' lengths available
- 2-3/8" diameter all welded walk through frame
- Pressure treated pine or aluminum plank options available
- 1 or 2 sided ADA 8' versions
- Pre-drilled holes for Portable and Surface Mount (mounting hardware not included)
- Made in the USA

SIZE	STYLE	PRESSURE TREATED		ALUMINUM	
		 PRICE	PRICE	 PRICE	PRICE
6'	Walk-thru	1275995	\$1,466 <sup>99</sup>	1276039	\$2,489 <sup>99</sup>
8'	Walk-thru	1276008	\$1,576 <sup>99</sup>	1276046	\$2,632 <sup>99</sup>
8' ADA	Double sided	1276015	\$1,358 <sup>99</sup>	1276053	\$2,632 <sup>99</sup>
8' ADA	Single sided	1276022	\$1,576 <sup>99</sup>	1276060	\$2,630 <sup>99</sup>



8' PRESSURE TREATED TABLE

6' ALUMINUM TABLE

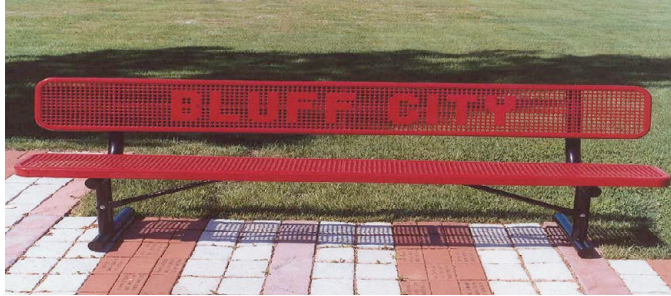



1275629 - 8' PERFORATED PORTABLE BENCH WITH PUNCHED CUSTOM LETTERING

## THERMOPLASTIC BENCHES W/CUSTOM LETTERING

- Benches can be customized with either punched or laser-cut lettering for a specialized look
- Available colors: Black, Brown, Green, Dark Blue, Burgundy, Light Blue, Red and Beige
- Call for lettering details

5 Year Limited Warranty

SIZE	PORTABLE	IN-GROUND	SURFACE MOUNT	PRICE EA.	DELIVERY
6'	1275599	1275605	1275612	\$2,560 <sup>99</sup>	
8'	1275629	1275636	1275643	\$2,656 <sup>99</sup>	

\*Price includes custom lettering

## ULTRACOAT™ THERMOPLASTIC COATED BENCHES

- 6' and 8' lengths available
- 12" wide seat
- Diamond and Perforated patterns available
- All welded frame made from 2-3/8" O.D. pipe
- Made in the USA

5 Year Limited Warranty

BENCH WITH BACK SUPPORT 					
SIZE	PORTABLE	IN-GROUND	SURFACE MOUNT	PRICE EA.	
6' DIA.	1275759	1275797	1275834	\$1,487 <sup>99</sup>	
6' PERF.	1275766	1275803	1275841	\$1,570 <sup>99</sup>	
8' DIA.	1275773	1275810	1275858	\$1,607 <sup>99</sup>	
8' PERF.	1275780	1275827	1275865	\$1,652 <sup>99</sup>	



6' BENCH WITH BACK - DIAMOND



LASER CUT LETTERING  
1275667 - 5' LEXINGTON WAVE BENCH

ENTIRE BENCH (FRAME INCLUDED)  
AVAILABLE ONLY IN ONE THERMOPLASTIC FINISH

## LEXINGTON WAVE BENCH

- Customized bench for a specialized look
- Custom lettering is included
- 12 letter spaces maximum for 4' benches
- 18 letter spaces maximum for 6' benches

5 Year Limited Warranty

1275650	4' Portable and/or Surface Mount	\$3,252 <sup>99</sup> EA	
1275667	6' Portable and/or Surface Mount	\$3,580 <sup>99</sup> EA	



6' BENCH - PERFORATED

BENCH WITHOUT BACK SUPPORT 					
SIZE	PORTABLE	IN-GROUND	SURFACE MOUNT	PRICE EA.	
6' DIA.	1275872	1275919	1275957	\$1,064 <sup>99</sup>	
6' PERF.	1275889	1275926	1275964	\$1,135 <sup>99</sup>	
8' DIA.	1275896	1275933	1275971	\$1,131 <sup>99</sup>	
8' PERF.	1275902	1275940	1275988	\$1,213 <sup>99</sup>	



1.



2.



3.

## BLEACHER COVERS

- Perfect for providing safety and comfort by protecting spectators from foul balls and excessive sunlight.
- All units feature durable black powder-coated steel posts designed for permanent installation
- Exclusive Shadsure™ cloth covering to block over 90% of harmful UV rays
- Professional installation recommended
- All structures have a 90 MPH windload rating and 5 lb. snowload rating (call for details on higher ratings)
- California public schools must call for DSA information.
- Please allow 6 to 8 weeks for delivery
- All covers carry a 10 year limited warranty with the exception of Red cover which carries a 3 year limited warranty.

### 1) Slanted Bleacher Covers Front is 10'H and Rear is 13'H

1100662	18' x 26'	\$9,084 <sup>99</sup> EA	
1100716	20' x 26'	\$9,568 <sup>99</sup> EA	

### 2) Standard Bleacher Covers

1100617	10'H x 15' x 15'	\$6,209 <sup>99</sup> EA	
1100518	10'H x 18' x 27'	\$7,853 <sup>99</sup> EA	
1100563	12'H x 18' x 36'	\$12,287 <sup>99</sup> EA	

### 3) Single Post Pyramid

1100860	10' x 10'	\$4,197 <sup>99</sup> EA	
1100914	12' x 12'	\$4,438 <sup>99</sup> EA	
1100969	14' x 14'	\$4,921 <sup>99</sup> EA	



## ADA ACCESSIBLE GRILL

- Same specs. as Rotating Flipback Grill
- 3-1/2" post
- ADA accessible at 28" height

1276091	280 sq. inch Cooking Area	\$608 <sup>99</sup> EA	
1276107	300 sq. inch Cooking Area	\$624 <sup>99</sup> EA	



## BI-LEVEL GRILL

- 1008 square inches of cooking area
- Utility shelf, grate adjusts to 4 different levels
- 4" square post
- High temp. powder coat finish

1276114	In-Ground	\$2,127 <sup>99</sup> EA	
1276121	Surface Mount	\$2,201 <sup>99</sup> EA	



32 GALLON CUSTOM LASER CUT TRASH RECEPTACLE



DOMELID



32 GALLON TRASH RECEPTACLE - DIAMOND

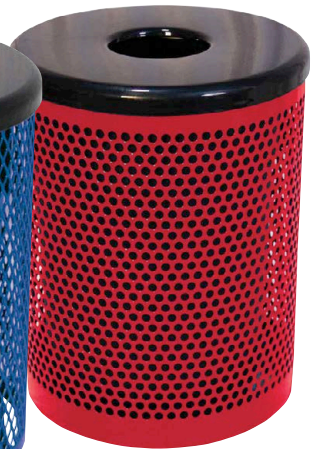

32 GALLON TRASH RECEPTACLE - PERFORATED



RAIN BONNET LID

**THERMOPLASTIC TRASH RECEPTACLES**

- 32 gallon trash receptacle is available in Diamond or Perforated patterns.
- Plastic liner and lids sold separately.
- Available colors: Black, Brown, Green, Dark Blue, Burgundy, Light Blue, Red and Beige.

**5 Year Limited Warranty**

1275698	Diamond - Specify Color	\$1,267 <sup>99</sup> EA	
1275704	Perforated - Specify Color	\$1,459 <sup>99</sup> EA	
1275711	Dome Lid - Black	\$307 <sup>99</sup> EA	
1275728	Flat Lid (8" Opening) - Specify Color	\$307 <sup>99</sup> EA	
1275735	Rain Bonnet - Specify Color	\$331 <sup>99</sup> EA	
1275742	Plastic Liner - Black	\$155 <sup>99</sup> EA	

**CUSTOM TRASH RECEPTACLES**

1275674	Diamond Pattern	\$1,461 <sup>99</sup> EA	
1275681	Perforated	\$1,582 <sup>99</sup> EA	

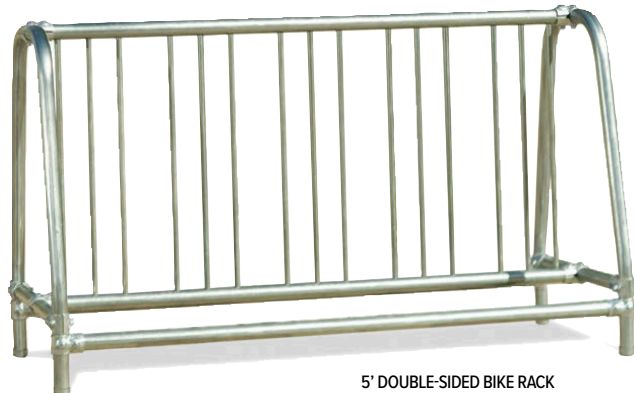

5' DOUBLE-SIDED BIKE RACK

**TRADITIONAL BIKE RACKS**

- Available as either in-ground, portable or surface mount design (mounting hardware not included)
- Constructed of 1 5/8"OD steel
- 5/8"OD rung bars
- All zinc plated hardware

**5 Year Limited Warranty**

1375258	5' Single sided - In ground	\$1,036 <sup>99</sup> EA	
1375259	5' Single sided - Portable	\$1,003 <sup>99</sup> EA	
1375260	5' Single sided - Surface Mount	\$1,100 <sup>99</sup> EA	
1375261	8' Single sided - In ground	\$1,133 <sup>99</sup> EA	
1375262	8' Single sided - Portable	\$1,118 <sup>99</sup> EA	
1375263	8' Single sided - Surface Mount	\$1,230 <sup>99</sup> EA	
1375264	10' Single sided - In ground	\$1,246 <sup>99</sup> EA	
1375265	10' Single sided - Portable	\$1,221 <sup>99</sup> EA	
1375266	10' Single sided - Surface Mount	\$1,320 <sup>99</sup> EA	
1375267	5' Double sided - In ground	\$1,090 <sup>99</sup> EA	
1375268	5' Double sided - Portable	\$1,060 <sup>99</sup> EA	
1375269	5' Double sided - Surface Mount	\$1,117 <sup>99</sup> EA	
1375270	8' Double sided - In ground	\$1,243 <sup>99</sup> EA	
1375271	8' Double sided - Portable	\$1,219 <sup>99</sup> EA	
1375272	8' Double sided - Surface Mount	\$1,312 <sup>99</sup> EA	
1375273	10' Double sided - In ground	\$1,434 <sup>99</sup> EA	
1375274	10' Double sided - Portable	\$1,401 <sup>99</sup> EA	
1375275	10' Double sided - Surface Mount	\$1,482 <sup>99</sup> EA	

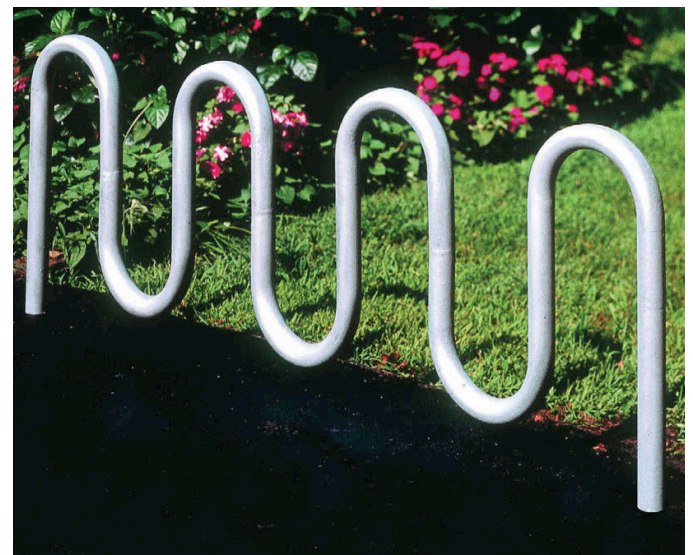

7 Loop Bike Rack

**CONTEMPORARY BIKE RACKS**

- All one piece - no assembly require
- Comprised of 2 3/8"OD steel tubing
- Available as in ground design or surface mount (mounting hardware not included)

**5 Year Limited Warranty**

1375247	1 Loop - 2 Bike - In ground design	\$613 <sup>99</sup> EA	
1375249	1 Loop - 2 Bike - Surface mount design	\$649 <sup>99</sup> EA	
1375250	3 Loop - 5 Bike - In ground design	\$1,018 <sup>99</sup> EA	
1375251	3 Loop - 5 Bike - Surface mount design	\$1,122 <sup>99</sup> EA	
1375252	5 Loop - 7 Bike - In ground design	\$1,137 <sup>99</sup> EA	
1375253	5 Loop - 7 Bike - Surface mount design	\$1,220 <sup>99</sup> EA	
1375254	7 Loop - 9 Bike - In ground design	\$1,252 <sup>99</sup> EA	
1375255	7 Loop - 9 Bike - Surface mount design	\$1,335 <sup>99</sup> EA	
1375256	9 Loop - 11 Bike - In ground design	\$1,562 <sup>99</sup> EA	
1375257	9 Loop - 11 Bike - Surface mount design	\$1,644 <sup>99</sup> EA	

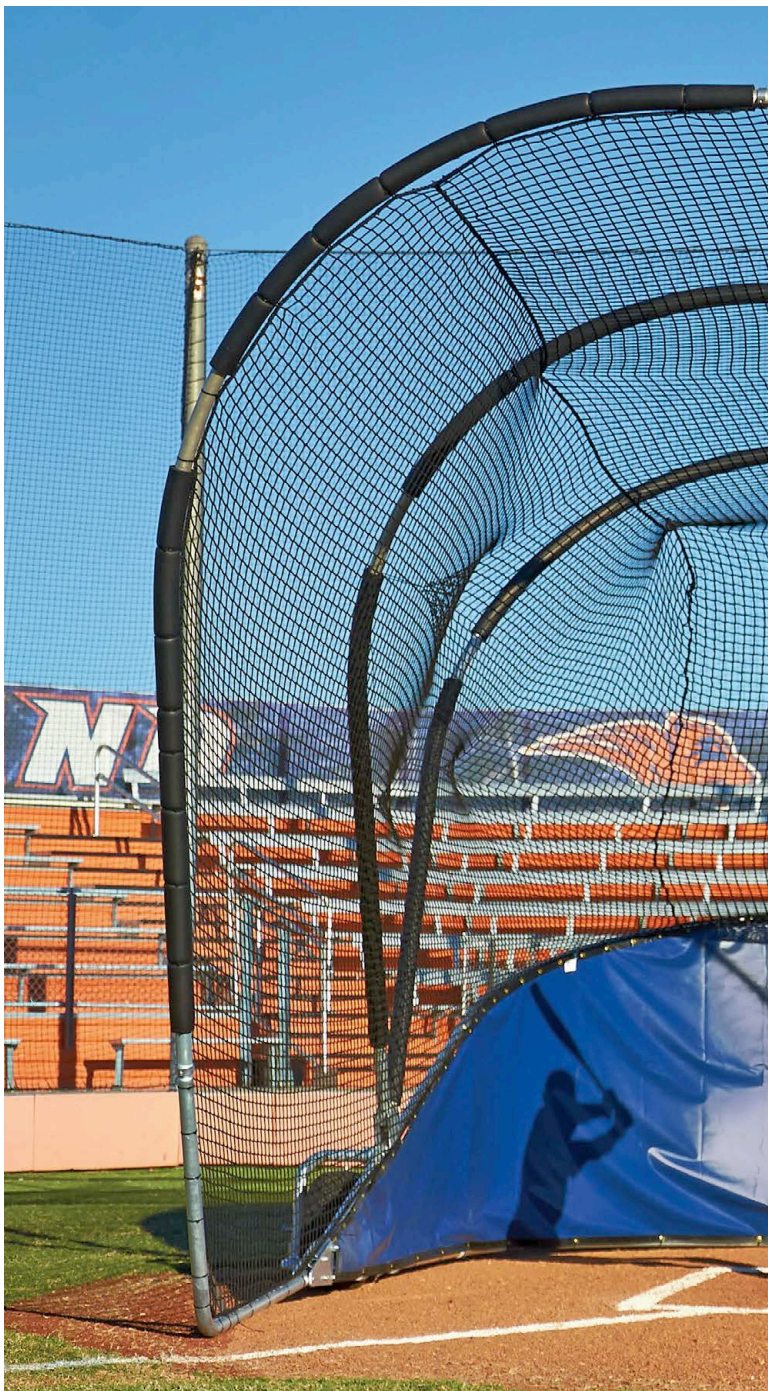
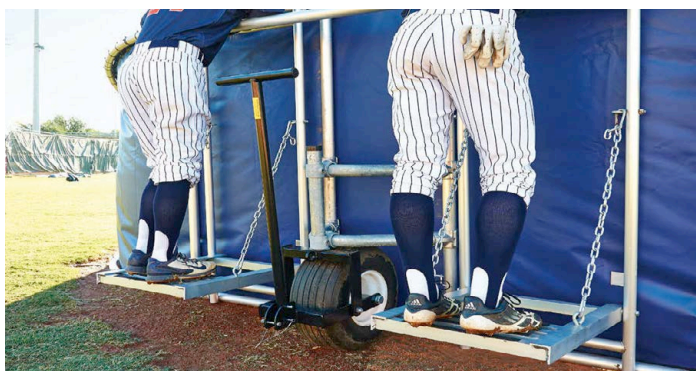



# BUBBA ELITE BATTING CAGE



## BUBBA ELITE BATTING CAGE

- Dual coaches observation platforms, 8.5"W x 18"H pneumatic tires, premium ricochet padding most frame work, 3.5mm weather-treated EHT net w/extra 10' x 10' baffle net, nylon reinforced 18oz. vinyl skirt, black thud pad w/grommets, and lockable dolly lift system portability
- Constructed of 2" heavy-wall aluminum tubing
- Collapses to only 5' high to limit storage
- Interior Dimensions: 18"W x 22"D x 12"H
- Exterior Width: 20'W
- Thud pad: 68"W x 52"H x 4"D
- Shipping Wt 625 lbs.

### STOCK SKIRT COLORS



# \$6,999<sup>99</sup>

BSELITE ★ Complete Unit 

**\$999<sup>99</sup>**

1316681 ★  
Replacement Dolly

**\$1,429<sup>99</sup>**

BIGBUBBANTDS ★  
Replacement Net

**\$699<sup>99</sup>**

BSBSK ★  
Replacement Skirt

**\$89<sup>99</sup>**

1273830 ★  
Ricochet Cushion

**\$629<sup>99</sup>**

1217612DS ★  
Thud Pad

# BIG BUBBA

## PRO BATTING CAGE



**\$6,499<sup>99</sup>**

**BSBUBBA** ★ Complete Unit 

### BIG BUBBA PRO BATTING CAGE

- Constructed of 2" heavy-wall aluminum tubing, pneumatic tires, 42' of ricochet cushion, 3.5mm weather treated EHT net w/ extra 10'x10' baffle net, 18oz. vinyl skirt and lockable dolley lift system for easy portability.
- Optional thud pad features 18oz. vinyl cover.
- Interior Dims: 18'W x 22'D x 12'H
- Collapses to 19' W X 13.5' D X 5.5' H
- Exterior width: 19'W
- Shipping weight 408 lbs.
- 5 Year Limited Warranty

#### STOCK SKIRT COLORS



#### QUICKLY COLLAPSES FOR PORTABILITY & STORAGE

ADDITIONAL OPTIONS		
<b>1273830</b>	Ricochet Cushion - sold in 6' lengths	\$89 <sup>99</sup> EA ★
<b>BSBSK</b>	Repl. vinyl skirt (specify color)	\$699 <sup>99</sup> EA
<b>1274042</b>	Replacement Dolley	\$999 <sup>99</sup> EA ★
<b>BIGBUBBANTDS</b>	Replacement Net with Baffle	\$1,429 <sup>99</sup> EA



### SAFEFOAM PADDING

- Premium grade padding for fence tops, pipes, rails, around dugouts, etc.
- Pre-slit for easy installation
- Fits completely over any round pipe that is 2-1/8" in diameter
- Secure with 19" tie wraps (sold separately)
- Minimum order of 6 pieces

#### 5 Year Limited Warranty

Color Options: **Black, Blue, Grey, Green, Purple, Red, Yellow.**

1158847

K13109

Padding (8' piece)

Tie wraps (Black, Green, Yellow)

\$99<sup>99</sup> EA

\$79<sup>99</sup> 100/SET



### COACH'S VIEWING PLATFORM

- Coaches can now view batting practice from this portable, adjustable stand.
- Constructed of 1 1/2" round aluminum tubing.
- Each stand is 20" wide and 10.5" from the ground.
- The stand will fold for safety and convenient storage.

#### 5 Year Limited Warranty

BSBCPLT

\$599<sup>99</sup> EA ★



# COLLAPSIBLE & PORTABLE

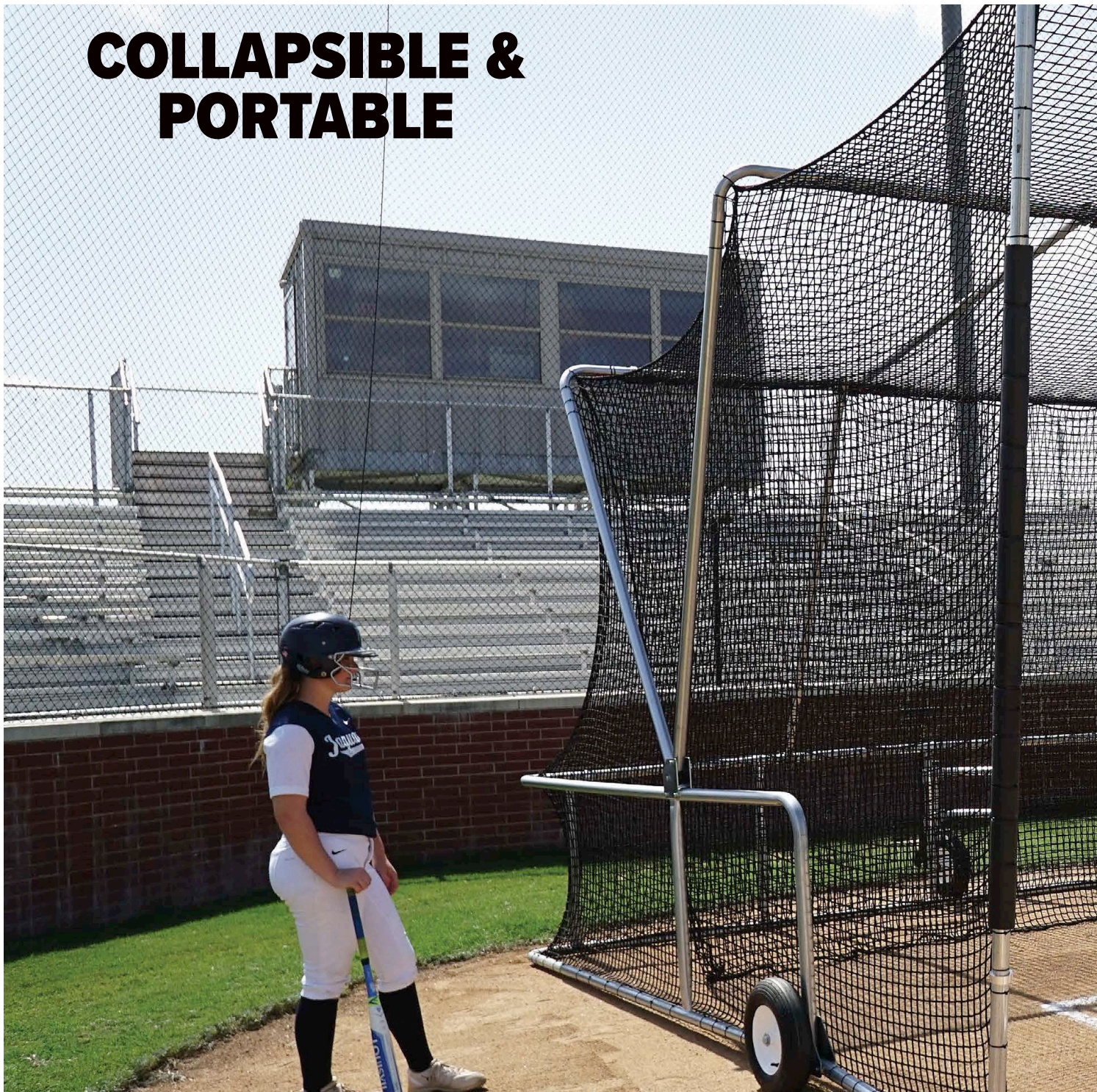

## FOLDABLE, PORTABLE BATTING CAGE

- Constructed of 2" O.D. 14 gauge flo-coated galvanized steel
- Features a lockable dolly lift system, three 16"D x 4"W pneumatic tires for easy mobility, 3.5 mm weather-treated EHT net with extra baffle net, 18' of ricochet cushion
- Optional 18 oz. vinyl skirt available for those who want a solid lower backdrop
- Interior dimensions: 16.5'W x 16.5'D x 11'H
- Weight: 650 lbs.

**BS4000F**

**1273830**

**1274042**

**1197525**

Complete unit  
Ricochet Cushion - sold in 6' lengths  
Replacement Dolly  
Replacement Net only

**\$6,299<sup>99</sup>** EA ★ 

**\$89<sup>99</sup>** EA ★

**\$999<sup>99</sup>** EA ★

**\$1,399<sup>99</sup>** EA ★



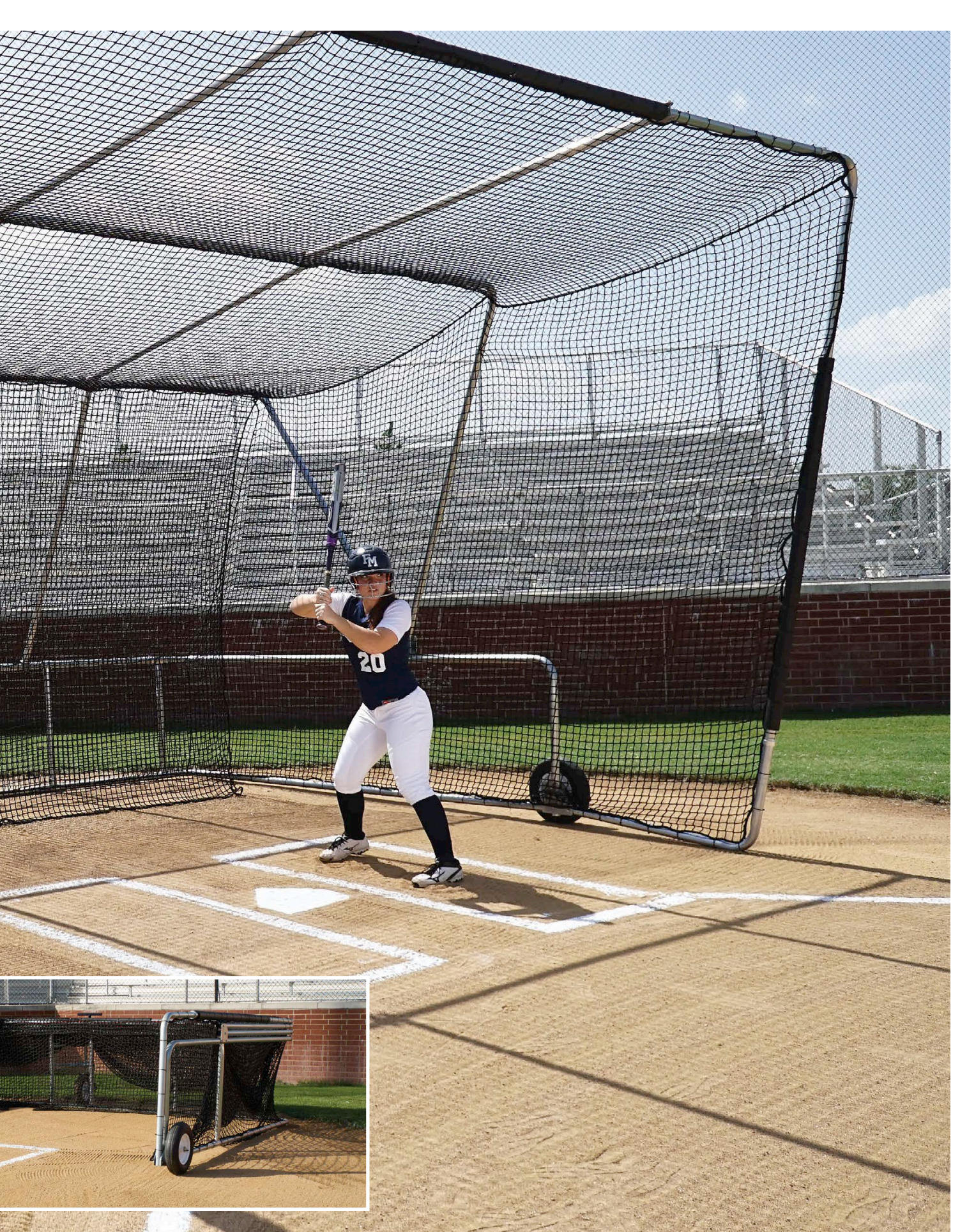

## PORTABLE BATTING CAGE

- Constructed of 2" O.D. 14 gauge flo-coated galvanized steel.
- Cage features include: lockable dolly lift system, three 16" D x 4" W pneumatic tires for easy mobility, heavy-duty 3.5 mm weather-treated EHT netting with extra baffle net behind batter.
- Extra width to accommodate left or right hand hitters without shifting the cage.
- Dims: 18" W x 12" D x 12.5' H
- Wt 500 lbs.

<b>BS4000</b>	Complete unit	\$4,999 <sup>99</sup>	EA ★	
<b>1273830</b>	Ricochet Cushion - sold in 6' lengths	\$89 <sup>99</sup>	EA ★	
<b>1274042</b>	Replacement Dolley	\$999 <sup>99</sup>	EA ★	
<b>1197518</b>	Replacement Net only	\$1,399 <sup>99</sup>	EA ★	



## CHAIN LINK BACKSTOPS

- Permanent backstops are erected by installing supplied 2-3/8" pipe supports approximately every 10' in concrete footings
- Then, simply bolt prefabricated 5' x 10' panels in place to create your finished backstop
- 5' x 10' panels are composed of 1-5/16" OD galvanized tubing with center reinforcing brace and 9 gauge galvanized woven wire
- Backstops are extremely durable and allow individual panels to be removed or replacement as needed

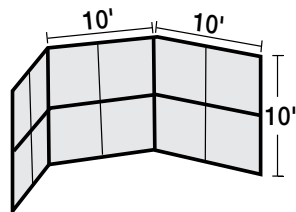

### 5 Year Limited Warranty

<b>BSCL10</b>	10' - No Hood or Wings	\$3,529 <sup>99</sup>	SET ★	
<b>BSCL10H</b>	10' w/Hood-No Wings	\$4,229 <sup>99</sup>	SET ★	
<b>BSCL20</b>	20' - No Hood or Wings	\$4,699 <sup>99</sup>	SET ★	
<b>BSCL10HW</b>	10' w/Hood & Wings	\$4,999 <sup>99</sup>	SET ★	
<b>BSCL20H</b>	20' w/Hood-No Wings	\$5,899 <sup>99</sup>	SET ★	
<b>BSCL20HW</b>	20' w/Hood & Wings	\$6,799 <sup>99</sup>	SET ★	



## BASEBALL HITTING STATION

- 2 3/8" diameter galvanized steel construction
- Installed dimensions - 10'H x 11'W x 1'D
- Can be installed permanently or semi permanent with included ground sleeves
- Turf mat not included - see page 37

### 3 Year Limited Warranty

#### BBHITSTA

Complete Unit

\$1,149<sup>99</sup> EA ★



### PHANTOM INDOOR BATTING CAGE

- 3 reach poles to eliminate the need for ladder
- 3 cam lock pulleys for net adjustments.
- Takes 2 people less than 5 minutes for set up/take down.

1459370	55'L x 14'W x 14'H	\$3,349 <sup>99</sup> EA	
1459371	70'L x 14'H x 14'W	\$3,649 <sup>99</sup> EA	

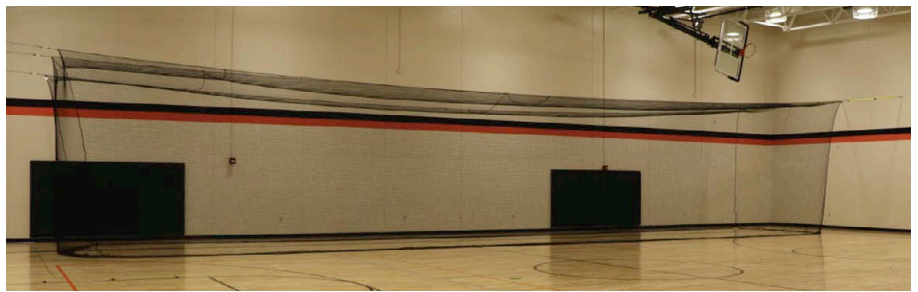

### MODULAR BATTING TUNNEL FRAME

- 3" OD galvanized steel pipe
- Steel support cables
- Ground cable kit
- Tensioned cuffs - Black only!
- Complete installation instructions
- Complete system includes: poles, net, hardware and cables

1373622	70' Single Tunnel	\$7,799 <sup>99</sup> EA	
1373623	70' Double Tunnel	\$12,329 <sup>99</sup> EA	
1373624	55' - Single Tunnel	\$6,499 <sup>99</sup> EA	
1373625	55' - Double Tunnel	\$9,999 <sup>99</sup> EA	



### BATTING CAGE DOOR

- All steel frame - easy to assemble
- Free standing door
- Lacing rope included
- Door size: 30 1/2"W x 72 1/2"H
- Door frame: 33 3/4"W x 76 1/2"H
- Weight 35 lbs.

K50651	\$449 <sup>99</sup> EA
--------	------------------------

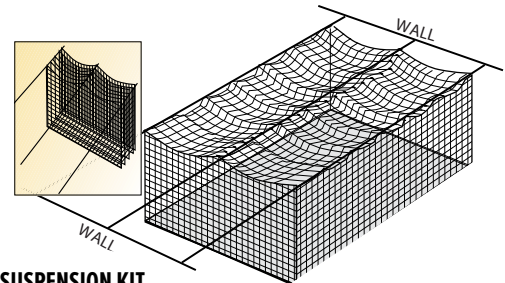

### INDOOR WALL TO WALL SUSPENSION KIT

- Includes everything you need to suspend a batting cage tunnel between two walls inside a gym or training facility (net not included)

1236637	\$589 <sup>99</sup> EA
---------	------------------------

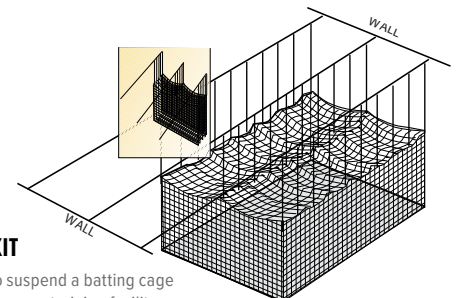

### CEILING NET SUSPENSION KIT

- Includes everything you need to suspend a batting cage tunnel from the ceiling inside a gym or training facility (net not included)

1236644	\$799 <sup>99</sup> EA
---------	------------------------

# VARSITY TUNNEL FRAMES

**COACH'S CHOICE**

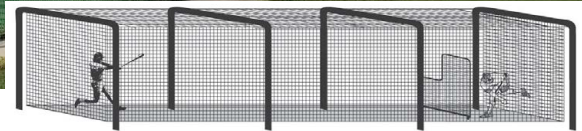

## VARSITY TUNNEL FRAMES

- Constructed of 2" round, 13 gauge galvanized steel powder coated black tubing
- System includes upright poles, cross member, ground sleeves, cable, clamps, eyebolts, turnbuckle and snap rings
- Fits all cages up to 14' W and 12' H
- Frame size after installation is 16' W x 12' H
- Net will hang at 11' - allowing 1' on the ground to contain balls

- Recommend: Collegiate Series Tunnel Nets - sold separately
- 3 Section frame for nets 55' and shorter
- 4 Section frame for nets 70' and longer

**BS10000**  
**BS10004**  
**BBFRMHDW**

3 Section Frame  
4 Section Frame  
Replacement Hardware Only

\$1,999<sup>99</sup> EA ★ **S&H**  
\$2,479<sup>99</sup> EA ★ **S&H**  
\$409<sup>99</sup> EA ★

# PRO TUNNEL FRAMES



Shown with Turf Roll (sold separately)

## PRO TUNNEL FRAME

- Super-Duty 3.5" OD 13-gauge galvanized steel pipe
- Available in surface mount, in ground and semi-permanent (with use of optional ground sleeves)
- Includes steel cable, clamp, turn buckles and quick links
- Complete installation instructions and hardware included
- 16'W x 11.5'H

**5 Year Limited Warranty**

**1253634** 3 Section Frame - Surface Mount  
**1274639** 4 Section Frame - Surface Mount  
**1375091** 3 Section Frame - In Ground  
**1375092** 4 Section Frame - In Ground  
**1375093** Ground sleeves (optional)

\$4,149<sup>99</sup> EA ★ **S&H**  
\$4,949<sup>99</sup> EA ★ **S&H**  
\$3,899<sup>99</sup> EA ★ **S&H**  
\$4,999<sup>99</sup> EA ★ **S&H**  
\$169<sup>99</sup> PR ★







**Gold Medal**  
ATHLETIC PRODUCTS

**QUALITY. DURABILITY.  
CRAFTSMANSHIP.**

**OVER 125 YEARS**



### ALL-STAR TUNNELS

- 3.5mm, 1-3/4" black nylon netting
- 36 thread twisted knotted
- 380 lb. breaking test
- Nyothene weather treatment for outdoor use
- Durable vinyl border
- Includes 14' x 12' backing to resist net wear behind batter
- Includes three full-length ropes to prevent sagging

<b>1245059DS</b>	55'L x 14'W x 12'H	\$2,999 <sup>99</sup>	EA ★	
<b>1245042DS</b>	70'L x 12'W x 12'H	\$3,199 <sup>99</sup>	EA ★	
<b>1245035DS</b>	70'L x 14'W x 12'H	\$3,299 <sup>99</sup>	EA ★	

### COLLEGIATE SERIES TUNNELS

- 2.0mm #24 twisted knotted polyethylene
- 185 lb. breaking strength
- UV treated - 100% waterproof
- 2mm size 1 3/4 square mesh
- For indoor or outdoor use
- Same great features as Pro Series tunnels, but for those on a tighter budget

<b>1149388</b>	70'L x 14'W x 12'H	\$1,649 <sup>99</sup>	EA ★	
<b>1149401</b>	70'L x 12'W x 12'H	\$1,599 <sup>99</sup>	EA ★	
<b>1241044</b>	55'L x 14'W x 14'H	\$1,529 <sup>99</sup>	EA ★	
<b>1149395</b>	55'L x 14'W x 12'H	\$1,449 <sup>99</sup>	EA ★	
<b>1241037</b>	35'L x 14'W x 12'H	\$1,179 <sup>99</sup>	EA ★	

### PRO SERIES TUNNELS

- 2.5mm #42 twisted knotted polyethylene
- 225 lb. breaking strength
- 100% water proof and UV treated
- Extruded permanent black color
- 1 3/4" square mesh
- Three ropes running lengthwise on top and all 4 corners for "no sag" net system

<b>1149340</b>	70'L x 14'W x 12'H	\$1,899 <sup>99</sup>	EA ★	
<b>1149357</b>	70'L x 12'W x 12'H	\$1,799 <sup>99</sup>	EA ★	
<b>1242478</b>	55'L x 14'W x 14'H	\$1,699 <sup>99</sup>	EA ★	
<b>1149371</b>	55'L x 14'W x 12'H	\$1,599 <sup>99</sup>	EA ★	
<b>1149364</b>	55'L x 12'W x 12'H	\$1,549 <sup>99</sup>	EA ★	

# NET SAVERS



### TUNNEL/CAGE SAVERS

- Heavy duty reinforced vinyl tarp to protect the netting in your batting cage
- Includes grommets and corner ropes
- Size - 5'W x 7'H

<b>1236651</b>	22 oz. vinyl w/ White Target	\$399 <sup>99</sup>	EA
<b>1269918</b>	30 oz. Black w/ Orange Target	\$399 <sup>99</sup>	EA
<b>1269925</b>	30 oz. Navy w/ Yellow Target	\$399 <sup>99</sup>	EA



### BATTING TUNNEL NET PROTECTOR PAD

- Protect your tunnel with this vinyl covered backstop pad
- Perfect for any indoor or outdoor batting cage
- Size - 3'W x 4'H x 1-1/2" thick

<b>200180453DS</b>	\$319 <sup>99</sup>	EA
--------------------	---------------------	----



### VINYL BACKDROP WITH TARGET

- Constructed of heavy duty 40oz. vinyl with white strike zone.
- Strike zone is 18"W x 30"H

<b>1323467</b>	Size - 5'W x 6'H	\$269 <sup>99</sup>	EA
----------------	------------------	---------------------	----



- Heavy-duty 11/2" square 17 gauge galvanized steel
- Fames are 7' H x 7' W
- 2.5mm twisted knotted polyethylene slip-on pillow case style net



**L- SCREEN**

**1399586** Complete Unit \$549<sup>99</sup> EA ★ **S&H**  
**1148657** Replacement Net \$229<sup>99</sup> EA ★



**SOCK NET**

**1399587** Complete Unit \$689<sup>99</sup> EA ★ **S&H**  
**1148695** Replacement Net \$279<sup>99</sup> EA ★



**SOFTBALL PITCHERS PROTECTOR**

**1399588** Complete Unit \$589<sup>99</sup> EA ★ **S&H**  
**1148718** Replacement Net \$279<sup>99</sup> EA ★



**FIRST BASE/FUNGO PROTECTOR**

**1399589** Complete Unit \$629<sup>99</sup> EA ★ **S&H**  
**1148671** Replacement Net \$199<sup>99</sup> EA ★



**C-SHAPED SOFTBALL PITCHERS PROTECTOR**

**1453177** Complete Unit \$549<sup>99</sup> EA ★ **S&H**  
**1366836N** Replacement Net \$259<sup>99</sup> EA ★



**L-SCREEN W/ HOOD**

**1453178** Complete Unit \$699<sup>99</sup> EA ★ **S&H**  
**1378703** Replacement Net \$329<sup>99</sup> EA ★

- Oversized for maximum protection
- Heavy wall construction
- Slip-over pillow case (3.0 mm) NYLON NET INCLUDED
- 10" NO flat tires for easy transporting

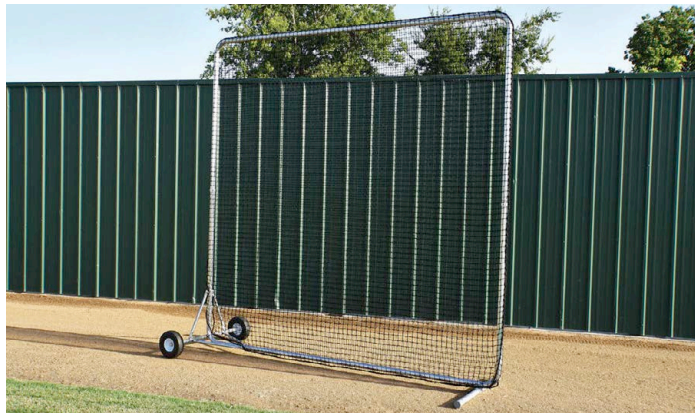

**BASE/FUNGO SCREENS**

<b>BSFPRO10</b>	Complete Unit - 10' x 10'	\$1,489 <sup>99</sup>	EA ★	
<b>1148619</b>	Replacement Net - 10'H x 10'W	\$359 <sup>99</sup>	EA ★	
<b>BSFPRO8</b>	Complete Unit - 8' x 8'	\$1,349 <sup>99</sup>	EA ★	
<b>1148596</b>	Replacement Net - 8'H x 8'W	\$359 <sup>99</sup>	EA ★	



**MINI PRO L-SCREEN**

<b>BSFPRO5</b>	Complete Unit (5' x 7' - on field)	\$999 <sup>99</sup>	EA ★	
<b>1296464</b>	Replacement Net	\$269 <sup>99</sup>	EA ★	
<b>1378702</b>	Complete padding option for Mini L Screen	\$189 <sup>99</sup>	EA ★	



**TRI-FOLD FUNGO SCREEN**

<b>BSFPRO16</b>	Complete Unit - 8'H x 16'W	\$1,899 <sup>99</sup>	EA ★	
<b>1148596</b>	Replacement Net - Middle Section	\$359 <sup>99</sup>	EA ★	
<b>1265279</b>	Replacement Net - Side Wings (pair)	\$399 <sup>99</sup>	PR ★	



**PRO L-SCREEN**

<b>BSPROL</b>	Complete Unit - 8' x 8' - Aluminum (on field)	\$1,599 <sup>99</sup>	EA ★	
<b>BSPROLS</b>	Complete Unit - 8' x 8' - Steel (on field or in tunnel)	\$1,599 <sup>99</sup>	EA ★	
<b>1148572</b>	Replacement Net - 8' x 8'	\$369 <sup>99</sup>	EA ★	
<b>1378694</b>	Complete padding option for L-Screen	\$189 <sup>99</sup>	EA ★	



# WORLD-CLASS WINDSCREENS

## TUFFY® WINDSCREENS

Our proprietary Tuffy® Windscreens is the only windscreen featuring lock-stitch finishing to assure that it's sides and corners do not unravel.

- Made with Vipol® Matrix 10 oz material, a super-durable mesh fabric of tightly woven micro fibers
- Sun UV resistance and mildew inhibitor protected
- Virtually tear proof and has the highest puncture and tear resistance
- Allow 22% wind pass-through, 78% shade factor
- Grommets every 12" on all 4 sides
- 9' model complete w/half moon vents
- 5 year limited warranty

### WITHOUT PRINTING

1323566	up to 5'H	\$1 45	SO.FT
1285598	6'H	\$1 59	SO.FT
1285604	9'H	\$1 69	SO.FT

### WITH DIGITAL IMPRINTING

1452960	up to 5'H	\$9 49	SO.FT
1452961	6'H	\$9 49	SO.FT
1452962	9'H	\$9 49	SO.FT

### WINDSCREEN ACCESSORIES

1298253	Boxed Air Vent	\$15 99	EA
<b>MITWRAPS</b>	7" Tie Wraps (50 lbs. brk strength - pk of 100)	\$52 99	PACK

### COLOR AVAILABILITY FOR VIPOL MATRIX WINDSCREENS

BLACK	WHITE	BROWN	BURNT ORANGE	TROPICAL ORANGE	VEGAS GOLD	GOLD	BEIGE	YELLOW
KELLY GREEN	AQUA	CC SKY BLUE	ROYAL BLUE	PRO BLUE	NAVY BLUE	PURPLE	RED	SCARLET
GREY	FOREST GREEN	MIDNIGHT GREEN	MAROON	DK SPORTS GREY				

Ask About Our Innovative Closed-mesh Technology



**QUALITY • DURABILITY • CRAFTSMANSHIP**



**BSN SPORTS<sup>™</sup>  
POLYESTER WINDSCREEN**

- 8oz. weight/sq. yard construction, 84% shade factor, maximum UV protection
- Custom cut to any size
- Brass tooth grommets spaced every 18" on all four sides
- IncrediSeal - eliminates all sewing and stitching
- 9' comes standard with lacing lip and half moon vents
- Match school logos exactly-digitally printed directly from your image file
- State of the art digital printing with unlimited color options

**Without Printing**

1393784	up to 5'H	\$17 SQ.FT
1393785	6'H	\$123 SQ.FT
1393786	9'H	\$127 SQ.FT

**With Printing**

1398129	up to 5'H	\$7 <sup>49</sup> SQ.FT
1398130	6'H	\$7 <sup>49</sup> SQ.FT
1398131	9'H	\$7 <sup>49</sup> SQ.FT



**POLY AND ARMORMESH WINDSCREEN ACCESSORIES**

1397737	Boxed Vent	\$14 <sup>99</sup> EA
1397738	Lacing Lip	\$0 <sup>10</sup> EA
<b>MTTWRAPS</b>	7" Tie Wraps (50 lbs. brk strength - pk of 100)	\$52 <sup>99</sup> PACK



**ARMORMESH WINDSCREEN**

- Features 14 oz. woven, extrusionvinyl-coated polyester
- Excellent tear strength and outstanding abrasion resistance
- Fabricated with IncrediSeal technology
- 75% shade factor
- Lacing lip and half moon vents standard on screens over 6'
- Match school logos exactly-digitally printed directly from your image file
- State of the art digital printing with unlimited color options

**Without Printing**

1393787	up to 5'H	\$12 SQ.FT
1393788	6'H	\$17 SQ.FT
1393789	9'H	\$19 SQ.FT

**With Printing**

1398132	up to 5'H	\$7 <sup>99</sup> SQ.FT
1398133	6'H	\$7 <sup>99</sup> SQ.FT
1398134	9'H	\$7 <sup>99</sup> SQ.FT

**6 YEAR LIMITED WARRANTY**



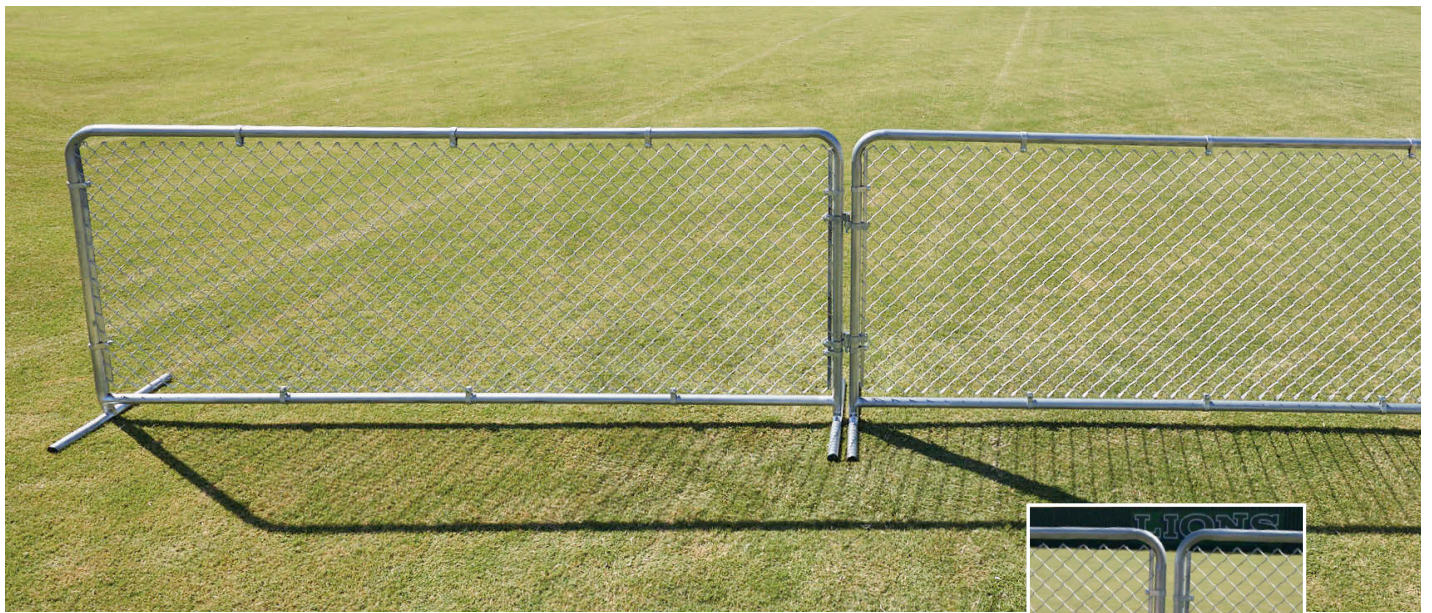

### PORTABLE CHAIN LINK FENCE PANELS

- Heavy duty portable chain link fence panels 4'H x 10'L can be used for home run, sideline, crowd control fencing, etc.
- Constructed of galvanized steel frame with 11 gauge chain link fabric
- Legs pivot for storage
- Supplied with connectors to secure panels together
- Weight: 62 lbs. per panel
- Actual freight charges apply
- Minimum purchase of 5 panels

**BS10680**

\$549<sup>99</sup> EA ★ 

### SAF TOP FENCE GUARD

- Teardrop shaped UV treated HDPE
- Pre-drilled holes every 24"
- Packed 12 sections
- 2"W x 4"T x 7'L = 84' per carton
- 1-Year Limited Warranty
- Available Colors: Red, Green, Yellow

1459340

Specify Color

\$259<sup>99</sup> SET OF 10

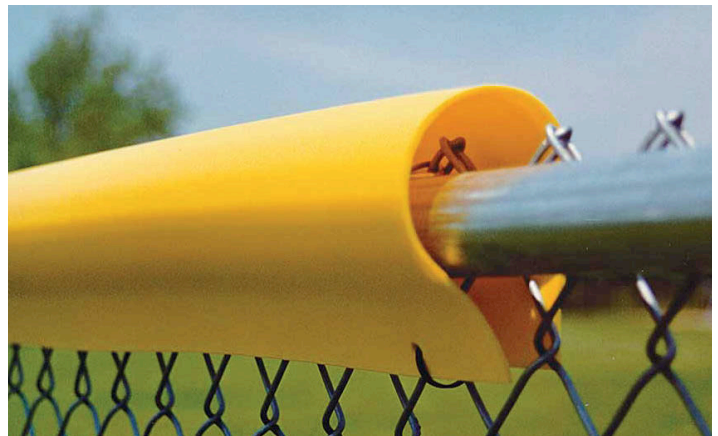

### DELUX FENCE TOP RAIL PADDING

- Provides superior appearance and protection on the top of chain link and outfield fences.
- 2" thick foam is encased in 18 oz. vinyl w/ grommets for attachment.
- Fits up to 2 1/2" pipe

K14065

6' section

\$159<sup>99</sup> EA



**FENCE GUARD**

- Installed over your chain link fence adds safety and reduces player injuries
- Increases visibility
- Beautifies any field
- Weather treated and UV protected
- 4-1/2" in diameter
- Actual freight charges apply

<b>BBPC100X</b>	Yellow 100'	\$279 <sup>99</sup> ROLL	
<b>BBPC250X</b>	Yellow 250'	\$399 <sup>99</sup> ROLL	
<b>5POLYINST</b>	Fence Guard Installation Tool	\$127 <sup>99</sup> EA	



**FENCE CROWN**

- An economical way to increase safety
- Reduce player injuries and increasing visibility
- Weather treated and UV protected
- Slit and ready for easy installation with matching tie wraps every 3'
- Tie wraps NOT included
- Actual freight charges apply

<b>1196726</b>	Bright Yellow - 100'	\$279 <sup>99</sup> ROLL	
<b>1196733</b>	Bright Yellow - 250'	\$399 <sup>99</sup> ROLL	
<b>1269949</b>	Black - 100'	\$279 <sup>99</sup> ROLL	
<b>1269932</b>	Black - 250'	\$399 <sup>99</sup> ROLL	
<b>1196764</b>	Yellow - 19" tie wraps - 100 per pack	\$99 <sup>99</sup> PACK	
<b>1269956</b>	Black - 19" tie wraps 100 per pack	\$99 <sup>99</sup> PACK	



**BLACK & YELLOW  
TIE WRAPS  
SOLD SEPARATELY**





### PORTABLE OUTFIELD FENCING

Durable polyethylene square mesh fencing, ideal for use as a stand alone outfield fence when combined with the Smartpole staking system. Rolls are 48”H x 150’L. Sold as packages that include fence rolls, poles and socket.

Specify fence color: **Blue, Dark Green, Scarlet**

### COMPLETE OUTFIELD PACKAGE

Includes:

- 150’ of fencing (specify color)
- 16 - 60” smartpoles (2 anchor poles + 14 flexible poles)
- 16 - 12” ground sockets with caps
- Punch-pilot hole tool
- Socket setter and installation sheet

Color Options: **Blue, Dark Green, Scarlet.**

**MKGMF6S**

Specify Color

**\$699<sup>99</sup>** SET

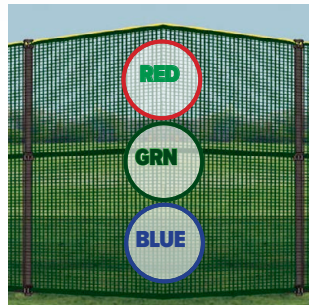

### OUTFIELD PACKAGE WITHOUT GROUND SOCKETS

Includes:

- 150’ of Fencing (specify color)
- 16 - 60” SmartPoles (2 anchor poles + 14 flexible poles)
- Punch-pilot hole tool
- Socket setter and installation sheet

Color Options: **Blue, Dark Green, Scarlet.**

**MKGMF5S**

**\$629<sup>99</sup>** SET

### SMART POLES WITH GROUND SOCKET KIT

- 16 - 60” SmartPoles (14 flex + 2 anchor)
- 16 - 12” ground sockets
- Punch pilot hole tool
- Socket setter
- 160’ yellow poly rope
- 50 tie wraps for added stability

**MK16SP60**

**\$449<sup>99</sup>** SET

### SMART POLE ONLY KIT

- 16 - 60” SmartPoles (14 flex + 2 anchor)
- Pilot hole
- 160’ yellow poly rope
- 50 tie wraps for added stability

**MK16SSCP**

**\$389<sup>99</sup>** SET

### SMARTPOLE FLEXIBLE POLE

- Replacement flexible SmartPole

**MKFS60**

Black

**\$36<sup>99</sup>** EA

### SMARTPOLE REINFORCED ANCHOR POLE

- Replacement anchor pole

**MKRS60**

White

**\$37<sup>99</sup>** EA



### 16 SMARTPOLE GROUND SOCKETS

- Optional set of 32 ground sleeves and caps for 200’ homerun Enduro fence system.

**MK16GS12CP**

16 Optional Ground Sockets with Caps

**\$299<sup>99</sup>** SET

### GROUND SOCKET WITH CAP

- Permanently install ground sockets for quick and easy fence installation and tear down

**MKGS12**

**\$17<sup>99</sup>** EA

### FENCING ONLY

- 48”H x 150’L fence only

Color Options: **Blue, Dark Green, Scarlet.**

**1196788**

specify color

**\$274<sup>99</sup>** ROLL ★

### HOW MUCH OUTFIELD FENCE DO YOU NEED?

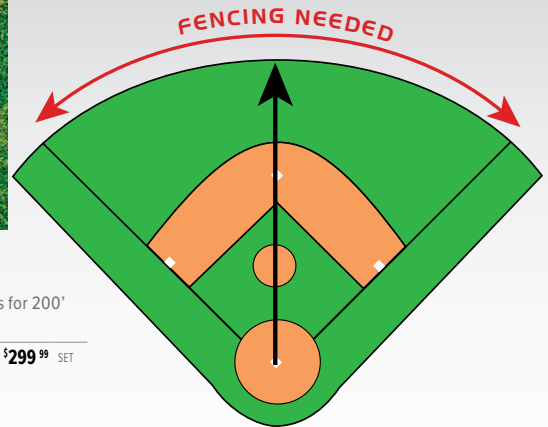

### HOME PLATE TO CENTER FIELD

### FENCING NEEDED

180'	282.6'
200'	314'
225'	353.25'
250'	392.5'
275'	431.75'
300'	471'
325'	510.25'
350'	549.5'
400'	628'



## ENDURO FENCING WITH YELLOW TOP TAPE

Sets a new standard for Simplicity, Durability and Appearance. Simply slide the poles through the permanent vinyl pockets in the mesh fencing and drive the pole into the turf with a rubber mallet. No ropes, ties, clips, hooks, etc. The vinyl pockets, spaced every 10', create an attachment to the pole that is uniform top to bottom. Steel pilot hole tool is included for hard ground. Optional ground sockets available. Color Options: **Dark Green, Red, Royal.**

## ENDURO FENCING OUTFIELD PACKAGES

Packages include:

- Enduro fence w/pole pockets
- Two (2) white Enduro anchor poles (MKREP1)
- Heavy-duty Enduro flex poles (MKWEP1)
- Steel pilot hole tool

Color Options: **Blue, Dark Green, Red.**

<b>BSF50BP</b>	50'L Fence with 6 Poles	<b>\$499<sup>99</sup></b> SET
<b>BSF150BP</b>	150'L Fence with 16 Poles	<b>\$969<sup>99</sup></b> SET

## 200' HOMERUN FENCE PACKAGE

Package includes:

- 314' of Enduro fence
- 32 Enduro poles
- Pilot-hole tool
- Measuring tape
- Optional ground sockets not included (see below)
- Dark Green only

<b>BS314GP</b>	Complete Package	<b>\$2,299<sup>99</sup></b> EA
<b>BS13516</b>	32 Optional Ground Sockets and Caps	<b>\$199<sup>99</sup></b> PACK ★

## 300' HOMERUN FENCE PACKAGE

Package includes:

- 471' of Enduro fence
- 48 Enduro poles
- Pilot-hole tool
- Measuring tape
- Optional ground sockets not included (see below)
- Dark Green only

<b>1335941</b>	Complete Package	<b>\$2,849<sup>99</sup></b> PACK ★
<b>BS13518</b>	48 Optional Ground Sockets and Caps	<b>\$299<sup>97</sup></b> KIT

## ENDURO FENCE ONLY

- Replacement fence only
- Please specify color

Color Options: **Dark Green, Red, Royal.**

<b>1236897</b>	50' - Roll only	<b>\$299<sup>99</sup></b> EA ★
<b>1236927</b>	150' - Roll Only	<b>\$699<sup>99</sup></b> EA ★

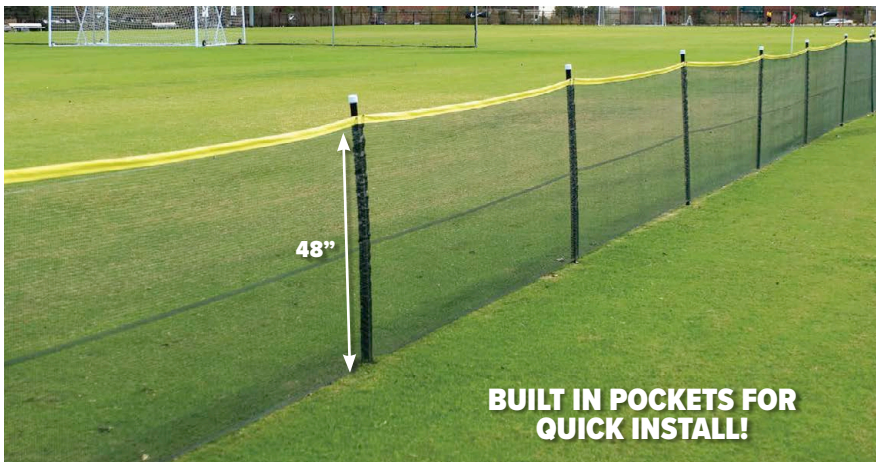

**BUILT IN POCKETS FOR QUICK INSTALL!**

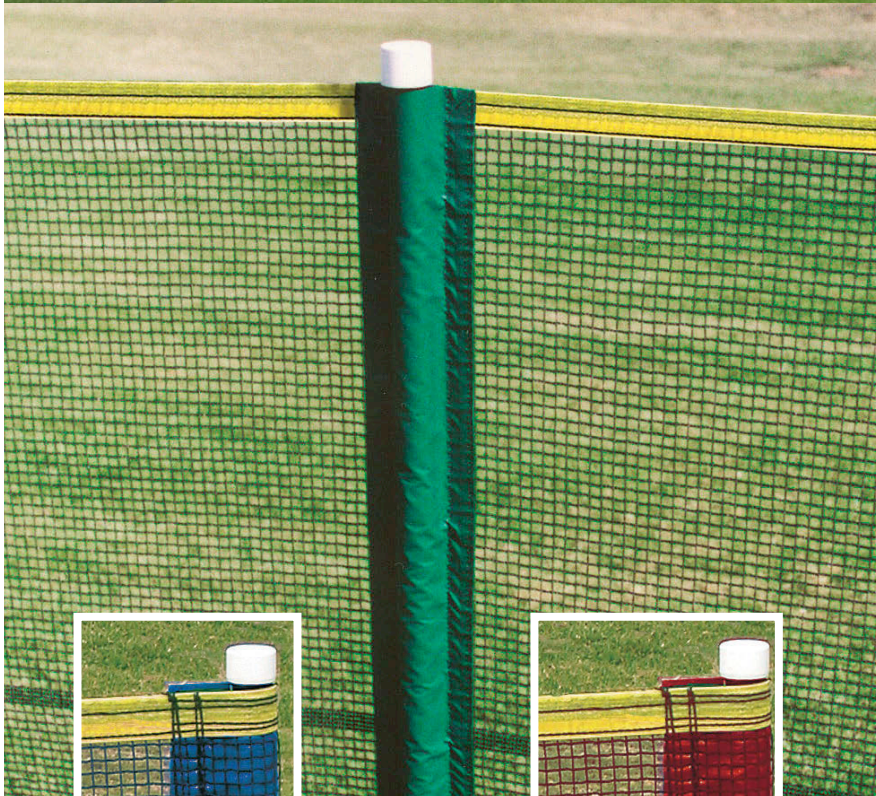

## ACCESSORIES

Additional Enduro Poles available for extra stability or replacement.



### ENDURO FLEXIBLE POLES

- Replacement flex poles

<b>MKWEP1</b>	Color: Black only	<b>\$37<sup>99</sup></b> EA
<b>MKWEP16</b>	Set of 16 (14 Flex + 2 Anchor Poles)	<b>\$349<sup>99</sup></b> SET

### ENDURO ANCHOR POLE

- Reinforced with metal rod to anchor the Enduro fence system

<b>MKREP1</b>	Color: White only	<b>\$37<sup>99</sup></b> EA
---------------	-------------------	-----------------------------

### GROUND SOCKET WITH CAP

- Permanently install ground sockets for quick and easy fence installation and tear down

<b>MKGS12</b>	<b>\$17<sup>99</sup></b> EA
---------------	-----------------------------

### GROUND SOCKET CAPS

- 12 pack of plugs for MarkSmart ground sockets
- Use color coded cap for multiple field configurations

<b>MKA103Y</b>	Caps Only - Specify Color	<b>\$21<sup>99</sup></b> OZN
----------------	---------------------------	------------------------------

### GROUND SOCKET SETTERS - ONE PAIR

- Designed to be placed in the ground socket so you can hit these instead of the ground socket directly

<b>MKA106</b>	<b>\$7<sup>49</sup></b> PR
---------------	----------------------------

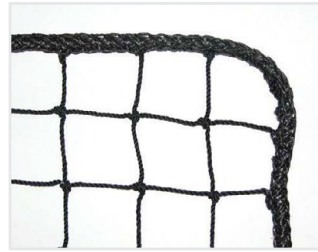

## CUSTOM NETTING









Rope Border



Vinyl Border w/Grommets

PROFESSIONAL #42 THREAD NETTING		
	KNOTTED	KNOTLESS
CONSTRUCTION	#42 Knotted	#42 Knotless
BREAK STRENGTH (approximate)	435 lbs.	337 lbs.
TREATMENT	UV dyed and protected	UV dyed and protected
CODE	1462266	1462268
PRICE	\$1 <sup>23</sup> SQ.FT	\$1 <sup>09</sup> SQ.FT

PROFESSIONAL #36 THREAD NETTING		
	KNOTTED	KNOTLESS
CONSTRUCTION	#36 Knotted	#36 Knotless
BREAK STRENGTH (approximate)	365 lbs.	306 lbs.
TREATMENT	UV dyed and protected	UV dyed and protected
CODE	1462267	1462269
PRICE	\$1 <sup>23</sup> SQ.FT	\$1 <sup>09</sup> SQ.FT

WHICH CUSTOM NET DO YOU NEED?				
TWINE SIZE	ALL-STAR	MVP	MAJOR LEAGUE	VARSITY
CONSTRUCTION	#36 Nylon Twisted-Knotted	3.5 mm Enduro Hybrid Thread Braided-Knotless	3.0 mm Enduro Hybrid Thread Braided-Knotless	2.4 mm Enduro Hybrid Thread Braided-Knotless
BREAK STRENGTH (approximate)	380 lbs.	320 lbs.	275 lbs.	195 lbs.
TREATMENT	Additional UV treatment and black color	Extruded thread with built in UV treatment, weather protection and Black color. Weather Proof, Mold and Mildew Resistant	Extruded thread with built in UV treatment, weather protection and Black color. Weather Proof, Mold and Mildew Resistant	Extruded thread with built in UV treatment, weather protection and Black color. Weather Proof, Mold and Mildew Resistant
WT / SQ FT	.040	.050	.036	.023
CODE	1238525	1188059	8042BKRD5	8066BKRD5
PRICE	\$1 <sup>23</sup> SQ.FT	\$1 <sup>09</sup> SQ.FT	\$1 <sup>03</sup> SQ.FT	\$0 <sup>99</sup> SQ.FT

## BOUNDARY NETTING



### NET REPAIR/LACING CORDS

• Black poly twine

<b>1236743</b>	100' Spool - 3mm	\$38 <sup>99</sup> SPOOL ★
<b>1236750</b>	500' Spool - 3mm	\$46 <sup>99</sup> SPOOL ★



### BAFFLE/DIVIDER NET WITH ROPE BORDER

• 2.5mm #42 thread twisted knotted polyethylene  
• Net can be hung inside your batting cage to divide it or act as a double back

<b>1236705</b>	Net Size - 12' x 14'	\$249 <sup>99</sup> EA ★
----------------	----------------------	--------------------------



### PRE-CUT BOUNDARY/PROTECTIVE NETTING

• 1-3/4" mesh, weather treated Varsity (#420) EHT black knotless netting  
• Netting is UV resistant  
• Heavy overlock stitched rope border  
• All panels are rectangular in shape

<b>1236576</b>	Net Size 10' x 30'	\$279 <sup>99</sup> EA ★
<b>1236583</b>	Net Size 12' x 50'	\$459 <sup>99</sup> EA ★
<b>1236590</b>	Net Size 14' x 50'	\$649 <sup>99</sup> EA ★
<b>1236606</b>	Net Size 14' x 100'	\$1,199 <sup>99</sup> EA ★

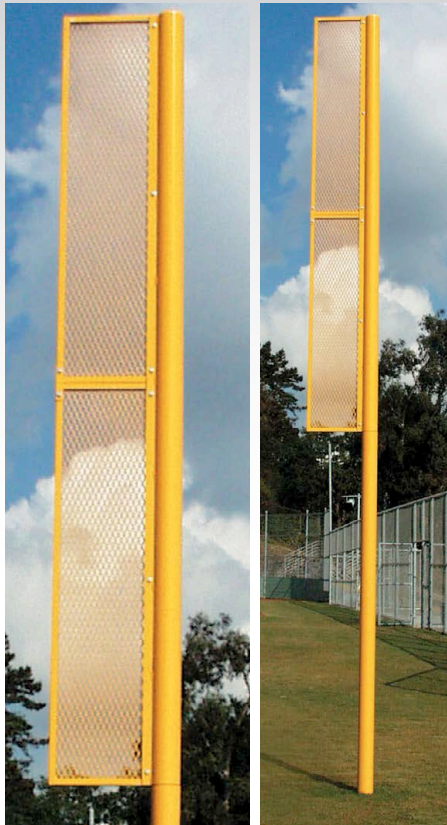

### PROFESSIONAL FOUL POLES (3 1/2" OD POLES)

- Constructed of 3.5" OD 13 gauge heavy duty steel
- Powder coated optic yellow
- Easy to see day or night
- Professional 18"W expanded metal wing
- Sold in pairs

<b>BSFOUL</b>	20' Above Ground, 12' Wing, Weight: 362 lbs/pr.	\$2,239 <sup>99</sup>	PR ★	
<b>BSFOUL15</b>	15' Above Ground, 8' Wing, Weight: 272 lbs/pr.	\$1,899 <sup>99</sup>	PR ★	
<b>BSFOUL12</b>	12' Above Ground, 6' Wing, Weight: 220 lbs/pr.	\$1,539 <sup>99</sup>	PR ★	

### GROUND SLEEVES FOR 3 1/2" OD FOUL POLES

<b>1255294</b>	48" Ground Sleeves for BSFOUL	\$479 <sup>99</sup>	PR ★
<b>1255287</b>	36" Ground Sleeves for BSFOUL15 or BSFOUL12	\$409 <sup>99</sup>	PR ★

### FOUL POLES

- Made of two sections that bolt together
- Sold in pairs
- Color Options: White, Optic Yellow, Optic Orange.
- Constructed of heavy-duty steel pipe
- Durable powder coated finish

#### 40' IN GROUND

PR334040C	Specify Color	\$10,879 <sup>99</sup>	PR	
-----------	---------------	------------------------	----	--

#### 32' IN GROUND

PR334032C	Specify Color	\$7,199 <sup>99</sup>	PR	
-----------	---------------	-----------------------	----	--

#### 24' IN GROUND

PR334024C	Specify Color	\$4,949 <sup>99</sup>	PR	
-----------	---------------	-----------------------	----	--

#### 16' IN GROUND

PR334016C	Specify Color	\$1,869 <sup>99</sup>	PR	
-----------	---------------	-----------------------	----	--

#### 12' IN GROUND

PR334012C	Specify Color	\$439 <sup>99</sup>	PR	
-----------	---------------	---------------------	----	--

#### 40' SURFACE MOUNT

PR334140C	Specify Color	\$11,949 <sup>99</sup>	PR	
-----------	---------------	------------------------	----	--

#### 32' SURFACE MOUNT

PR334132C	Specify Color	\$8,279 <sup>99</sup>	PR	
-----------	---------------	-----------------------	----	--

#### 24' SURFACE MOUNT

PR334124C	Specify Color	\$5,879 <sup>99</sup>	PR	
-----------	---------------	-----------------------	----	--



### STANDARD FOLDING BACKSTOP PADDING

- 2" polyfoam covered by heavy duty 18 oz. vinyl
- Pads are made to fold in 2'W panels for storage and shipping
- Grommets along all 4 sides for easy of anchoring
- Order with digital printing to dress up your facility

#### WITHOUT PRINTING

1397739	3'H x 6'L - Weighs 12 lbs.	\$579 <sup>99</sup>	EA	
1397753	3'H x 8'L - Weighs 16 lbs.	\$649 <sup>99</sup>	EA	
1397767	3'H x 10'L - Weighs 20 lbs.	\$689 <sup>99</sup>	EA	
1397781	3'H x 12'L - Weighs 24 lbs.	\$799 <sup>99</sup>	EA	
1397795	4'H x 6'L - Weighs 16 lbs.	\$679 <sup>99</sup>	EA	
1397809	4'H x 8'L - Weighs 20 lbs.	\$699 <sup>99</sup>	EA	
1397823	4'H x 10'L - Weighs 25 lbs.	\$799 <sup>99</sup>	EA	
1397838	4'H x 12'L - Weighs 30 lbs.	\$899 <sup>99</sup>	EA	

#### WITH PRINTING

1397852	3'H x 6'L - Weighs 12 lbs.	\$669 <sup>99</sup>	EA	
1397866	3'H x 8'L - Weighs 16 lbs.	\$799 <sup>99</sup>	EA	
1397880	3'H x 10'L - Weighs 20 lbs.	\$969 <sup>99</sup>	EA	
1397894	3'H x 12'L - Weighs 24 lbs.	\$1,129 <sup>99</sup>	EA	
1397908	4'H x 6'L - Weighs 16 lbs.	\$829 <sup>99</sup>	EA	
1397922	4'H x 8'L - Weighs 20 lbs.	\$969 <sup>99</sup>	EA	
1397936	4'H x 10'L - Weighs 25 lbs.	\$1,249 <sup>99</sup>	EA	
1397950	4'H x 12'L - Weighs 30 lbs.	\$1,429 <sup>99</sup>	EA	



### BACKSTOP PADDING

- Designed for use on chain-link fencing or cement
  - Features heavy-duty 18 oz. vinyl construction
  - 4" open cell form padding for true ball rebound
  - Grommets are exposed on all 4 sides for ease of attachment
  - Upgrade to printed padding for that "WOW" factor
- Color Options: **Black, Gray, Kelly, Maple Green, Maroon, Navy, Orange, Purple, Red, Royal, Sky Blue, Tan, White, Yellow.**

1398099	Without Printing	\$52 <sup>99</sup>	SO FT
1398114	With Printing	\$58 <sup>99</sup>	SO FT





### FULL FIELD TARP/COVER

- Constructed of 6 oz woven, 12ml thick polyethylene
- Double-stitched on all four sides with brass grommets placed evenly around the perimeter every 10-12 feet
- Reinforced corners
- Web handles evenly spaced around perimeter every 15' - 20'
- Includes 50 polypro sand bags (sand not included)

**3 Year Limited Warranty**

1150094	Baseball Cover 170' x 170', Weight: 1200 lbs	\$9,699 <sup>99</sup> EA	
1150100	Baseball Cover 160' x 160', Weight: 1090 lbs	\$9,499 <sup>99</sup> EA	
1150117	Softball Cover 120' x 120', Weight: 615 lbs	\$6,499 <sup>99</sup> EA	
1236774	Youth League Cover 90' x 90', Weight: 400 lbs	\$4,899 <sup>99</sup> EA	



### FIELD COVER ACCESSORIES

- |            |   |                                 |
|------------|---|---------------------------------|
| 1. 1150148 | 9" Anchor Stakes  | \$64 <sup>99</sup> DZN          |
| 2. 1150155 | Polypropylene Sand Bags (26" x 14") - 20 per set (Sand not Incl.) | \$239 <sup>99</sup> SET OF 20 ★ |
| 3. 1150162 | Fieldsaver Repair Tape, 3" x 60' Roll                             | \$84 <sup>99</sup> EA           |



Black	Dark Green	Grey	Brown
Navy	Burgundy	Purple	Tan
Yellow	Red	Royal	White

### FIELD TARP STORAGE ROLLER COVER

- Heavy duty 22oz vinyl
- Optional lettering available

K13487	3'T x 3'W x 20'L - used with 90' & 120' Tarps	\$429 <sup>99</sup> EA
K14281	3'T x 3'W x 34'L - used with 160' tarps	\$559 <sup>99</sup> EA
K35768	3'T x 3'W x 40'L - used with 170' tarps	\$779 <sup>99</sup> EA
1298154	Lettering up to 24" Tall	\$119 <sup>99</sup> EA



\*THE 40' AND 34' TWO-PIECE ROLLER CONNECTS WITH PROVIDED HARDWARE AND REQUIRE CONNECTS HOLES TO BE DRILLED AFTER DELIVERY.

### FIELD TARP STORAGE ROLLERS

- Heavy duty corrugated HDPE for tarp storage
- 2-piece rollers provide substantial savings on shipping cost
- Rollers are 28" in diameter

1158939	For 120' and 90' Tarps	\$1,069 <sup>99</sup> EA	
1158953	For 160' Tarps	\$2,049 <sup>99</sup> EA	
1236781	For 170' Tarps	\$2,099 <sup>99</sup> EA	

## VARSITY GRADE FIELD COVERS

- Composed of 5 oz woven polyethylene
- Super light, waterproof and mildew resistant
- Heat-sealed seams and double sewn reinforced perimeters
- Brass grommets spaced every 3'
- Ground stakes included with all covers
- Color: Green

<b>1150575</b>	Complete Set (1x 26'; 1x 20'; 3 x 10')	<b>\$1,099<sup>99</sup></b> SET ★
<b>1150544</b>	26' Circular Home Plate Cover	<b>\$629<sup>99</sup></b> EA ★
<b>1150551</b>	20' Circular Pitcher's Mound Cover	<b>\$479<sup>99</sup></b> EA ★
<b>1150568</b>	10' Square Base Covers	<b>\$359<sup>99</sup></b> SET ★

## COLLEGIATE GRADE FIELD COVERS

- Composed of 14 oz vinyl
- Heat-sealed seams and double sewn reinforced perimeters
- Brass grommets spaced every 3'
- Ground stakes included with all covers
- Color: Royal Blue

### 2 Year Limited Warranty

<b>1238457</b>	Complete Set (1x 26'; 1x 20'; 3 x 10')	<b>\$1,649<sup>99</sup></b> SET ★
<b>1149685</b>	30' Circular Cover	<b>\$1,049<sup>99</sup></b> EA ★
<b>1149692</b>	26' Circular Cover	<b>\$829<sup>99</sup></b> EA ★
<b>1149708</b>	20' Circular Cover	<b>\$599<sup>99</sup></b> EA ★
<b>1149715</b>	10' Square Base Covers	<b>\$449<sup>99</sup></b> SET ★

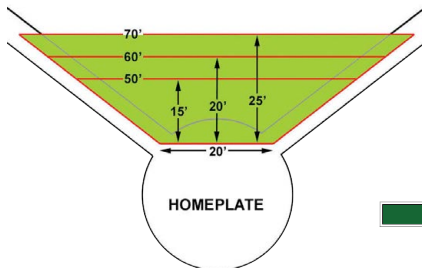

## BP ZONE® BASICTURF PROTECTOR

- Constructed of varsity level 9 oz. mesh material
- Perimeter edges are hemmed and grommets

<b>K13351</b>	20'W x 15'D x 50'L	<b>\$559<sup>99</sup></b> EA
<b>K13352</b>	20'W x 20'D x 60'L	<b>\$629<sup>99</sup></b> EA
<b>K13353</b>	20'W x 25'D x 70'L	<b>\$869<sup>99</sup></b> EA

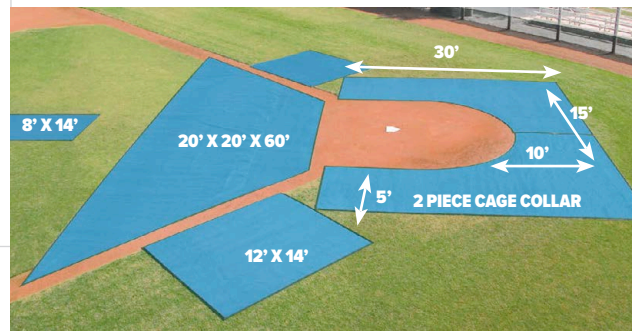

## FIELD WEIGHTS (SET OF 4)

- The perfect alternative to sand bags
- Features an easy grip handle
- Durable so they won't tear and leave a sandy mess

<b>1373618</b>	7 lbs each - 28lbs.	<b>\$319<sup>99</sup></b> SET
----------------	---------------------	-------------------------------



## FIELD WEIGHT & TARP CART

- Designed to transport area tarps and field weights
- Includes 1 set of 36 field weights
- Heavy duty, powder coated steel construction
- 2 large pneumatic turf tires
- Tow bar and wheel barrow handles
- Fits thru a standard door

<b>1373617</b>		<b>\$3,299<sup>99</sup></b> EA
----------------	--	--------------------------------

## BP ZONE® BATTING PRACTICE TURF PROTECTORS

- Tough 20 mil. VIPOL® Matrix Mesh provides the highest level of spike protection for turf
- Same material as used by top high schools, NCAA, Major League Baseball and NFL teams
- All edges are hemmed and grommets
- Complete set includes 8' x 14' blanket, 2 piece cage collar, two -12' x 14' blankets for fungo areas and a 20'W x 20'D x 60' across trapezoid shaped infield protector
- Available in 20 colors - see color bar below
- Chroma-Bond® imprinting available and sold separately

<b>1159899</b>	Complete Set	<b>\$2,749<sup>99</sup></b> SET
<b>1159905</b>	2 Piece Cage Collar Only	<b>\$1,299<sup>99</sup></b> PR
<b>1159912EA</b>	Individual 8' x 14' Turf Mat	<b>\$279<sup>99</sup></b> EA
<b>1159929EA</b>	Individual 12' x 14' Turf Mat	<b>\$319<sup>99</sup></b> EA
<b>1159837</b>	20'W x 20'D x 60' L	<b>\$1,329<sup>99</sup></b> EA

## WIND WEIGHTED FIELD TARPS

- Famous Rain covers that stay put without stakes or sandbags
- Steel chain in edge hem allows these tarps to stay down even in high winds
- Field proven to 65mph.
- Industrial 18oz. vinyl-polyester fabric with UV and mildew inhibitors
- Major League Style, rounded to fit inside dirt circle for extended use in sun and for optimum dirt moisture management

### 2 Year Limited Warranty

<b>K35566</b>	12' Diameter	<b>\$679<sup>99</sup></b> EA
<b>K35567</b>	18' Diameter	<b>\$999<sup>99</sup></b> EA
<b>K35568</b>	20' Diameter	<b>\$1,149<sup>99</sup></b> EA
<b>K35569</b>	26' Diameter	<b>\$1,449<sup>99</sup></b> EA
<b>K35570</b>	30' Diameter	<b>\$1,849<sup>99</sup></b> EA
<b>K35571</b>	10' x 10' Square	<b>\$499<sup>99</sup></b> EA



# BATTING CAGE TURF

## WHY BATTING CAGE TURF?

- Durable, long-lasting and easy to maintain
- Protects from inclement weather
- Softens ball impact
- Increases life of practice balls

### BSN PLATINUM

Constructed with nylon yarn, Platinum is our most durable and long-lasting turf option.

	SKU	Dimensions	Price
PADDED	1458164	15'W x 55'L	\$4,579.99 roll
	1458166	15'W x 70'L	\$5,899.99 roll
	1458168	Custom Length*	\$10.99/sq. ft.
UNPADDED	1458163	15'W x 55'L	\$3,099.99 roll
	1458165	15'W x 70'L	\$3,929.99 roll
	1458167	Custom Length*	\$7.29/sq. ft.

### BSN GOLD

Polyethylene yarn makes Gold a great all around turf option that is plush and soft to the touch.

	SKU	Dimensions	Price
PADDED	1458158	15'W x 55'L	\$3,399.99 roll
	1458160	15'W x 70'L	\$4,299.99 roll
	1458162	Custom Length*	\$8.49/sq. ft.
UNPADDED	1458157	15'W x 55'L	\$1,929.99 roll
	1458159	15'W x 70'L	\$2,479.99 roll
	1458161	Custom Length*	\$5.29/sq. ft.

### BSN SILVER

Silver is constructed with polypropylene yarn and is a great value option for your batting cage.

	SKU	Dimensions	Price
PADDED	1458152	15'W x 55'L	\$2,849.99 roll
	1458154	15'W x 70'L	\$3,549.99 roll
	1458156	Custom Length*	\$9.29/sq. ft.
UNPADDED	1458151	15'W x 55'L	\$1,449.99 roll
	1458153	15'W x 70'L	\$1,829.99 roll
	1458155	Custom Length*	\$3.69/sq. ft.



**PADDED**  
5mm foam



**PADDED**  
5mm foam

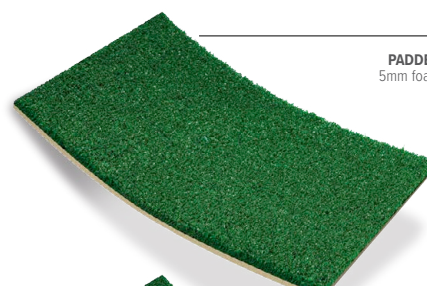

**PADDED**  
5mm foam

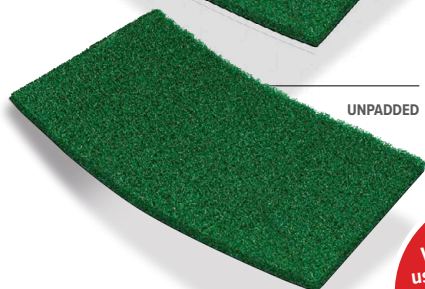

**UNPADDED**



**UNPADDED**



**UNPADDED**

We recommend using batting mats for high traffic areas to maximize the life of your turf.

#### PRODUCT GUIDANCE

**PADDED** - Best in applications that protect against moisture (indoor or covered structures). Consult with a sales pro for installation guidance (glue vs. loose-lay).

**UNPADDED** - For both indoor and outdoor applications, consult with a sales pro for installation guidance (glue vs. loose-lay).

\*Standard roll width is 15 feet. Custom lengths available. Minimum length is 12 feet. Maximum length is 100 feet.

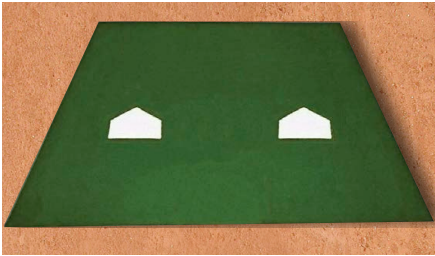

**DIAMONDTURF BULLPEN MAT**

- Comes with 2 side-by-side home plates
- Standard turf green only

1235944 12' x 12' - Weight: 135 lbs **\$999<sup>99</sup>** EA

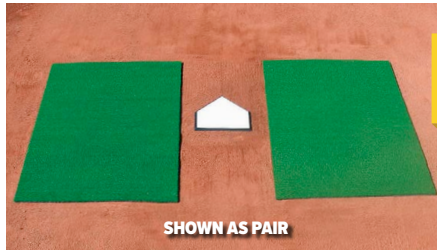

SHOWN AS PAIR

**DIAMONDTURF BATTER'S MATS**

- Standard turf green only

1235951 Baseball - 4' x 6' - Weight: 22 lbs. **\$399<sup>99</sup>** EA  
 1235968 Softball - 3' x 7' - Weight: 20 lbs. **\$289<sup>99</sup>** EA

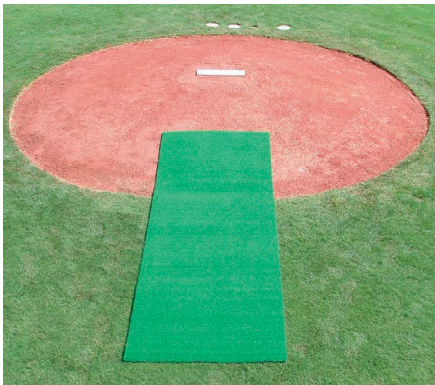

**DIAMONDTURF PITCHER'S MATS**

- Standard turf green only

1235920 4' x 12' - Weight: 30 lbs **\$499<sup>99</sup>** EA  
 1235937 6' x 12' - Weight: 58 lbs **\$529<sup>99</sup>** EA



GREEN, BLACK, ROYAL, RED, YELLOW, ORANGE, CLAY & WHITE

**DIAMONDTURF 6' ON-DECK CIRCLE**

- Weight: 40 lbs per pair

1235975 Green **\$679<sup>99</sup>** PR  
 K13823 Please Specify Color **\$739<sup>99</sup>** PR



**COACH'S CHOICE**

**HOME PLATE MATS!**



CLAY

**HOME PLATE MATS**

- For indoor/outdoor cages and on-the-field BP
- Will hold up to moderate spike-cleat traffic.
- Features a thick foam backing with inlaid white turf lines
- Comes with a heavy-duty throwdown home plate

1235890 Baseball (Clay) - 6' x 12' **\$699<sup>99</sup>** EA  
 1235906 Baseball (Green) - 6' x 12' **\$699<sup>99</sup>** EA  
 1235913 Softball (Green) - 7' x 12' **\$719<sup>99</sup>** EA

**BP MAT WITH CATCHERS EXTENSION**

- Attached with a six-foot-long sewn-on Velcro strip
- Velcro on both sides of the extension so the mat can be rotated for maximum use and minimum wear
- Heavy duty design will hold against a batter's twisting
- Easily rolled up and stored

1373619 Green **\$724<sup>99</sup>** EA  
 1373620 Clay **\$724<sup>99</sup>** EA

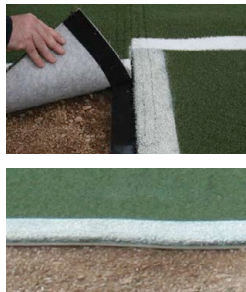

**DIAMONDTURF HALO MATS**

- Made from spike proof DiamondTurf
- Eliminates turf replacement and the need for constant maintenance around home plate
- Kits come pre-cut to fit a 13' radius from the rear point of home plate
- Requires a concrete or asphalt base under turf
- Comes with either a unitary (carpet without padding) backing or with a 5mm foam pad backing
- Green turf only

K13171	5' Halo Kit without wings (unitary backing)	<b>\$6,799<sup>99</sup></b> EA	
BSHK5P	5' Halo kit with wings (unitary backing)	<b>\$6,799<sup>99</sup></b> EA	
K13173	10' Halo Kit without wings (unitary backing)	<b>\$6,999<sup>99</sup></b> EA	
BSHK10P	10' Halo Kit with wings (unitary backing)	<b>\$9,299<sup>99</sup></b> EA	
K13175	5' Halo Kit without wings (foam pad backing)	<b>\$6,899<sup>99</sup></b> EA	
K13857	5' Halo Kit with wings (foam pad backing)	<b>\$7,499<sup>99</sup></b> EA	
K13177	10' Halo Kit without wings (foam pad backing)	<b>\$9,999<sup>99</sup></b> EA	
K13865	10' Halo Kit with wings (foam pad backing)	<b>\$10,899<sup>99</sup></b> EA	
K13871	1 Color Letter in 5' halo	<b>\$169<sup>99</sup></b> EA	
K13872	2 Color Letter in 5' halo	<b>\$239<sup>99</sup></b> EA	
K13881	1 Color Letter in 10' halo	<b>\$269<sup>99</sup></b> EA	
K13882	2 Color Letter in 10' halo	<b>\$429<sup>99</sup></b> EA	



2-COLOR LETTERING ON 10' HALO KIT WITH WINGS



# DIAMOND PRO

PROFESSIONAL GROUNDSKEEPING PRODUCTS

SOLD BY THE PALLET

CALL FOR FREIGHT QUOTE



### MOUND/HOMEPLATE CLAY BRICKS

- Mound/ Home plate clay bricks are unfired compressed clay bricks perfect for building or repairing high stress areas
- The bricks, when watered, simply turn to firm clay to provide durability and reduced maintenance in these areas
- Brick size: 4" x 8" x 2-1/2"
- 300 bricks per pallet

DPROB12TX \$969.99 PALLET



### MOUND/HOMEPLATE CLAY

- Mound/ Home plate clay is a screened clay loam with a rich red color, which easily conforms and binds to the existing surface
- The loose clay easily tamps into holes providing greater durability and less maintenance
- 50 lb. bags/40 bags per pallet

DPROCLTX \$769.99 PALLET



### ATHLETIC FIELD MARKING DUST

- Bright premium marking dust complies with the NCAA rules
- Non-toxic, non-burning and harmless to soil and turf
- 50 lb. bags/40 bags per pallet

DPROMDTX \$819.99 PALLET



### CALCINED CLAY TOP DRESSING

- A calcined clay product used on the skinned areas of baseball and softball fields to improve drainage
- The larger product size increases the durability of the product
- It will not stick to cleats and is easily incorporated into the infield
- 50 lb. bags/40 bags per pallet

DPROCCDTX \$889.99 PALLET



### CALCINED CLAY DRYING AGENT

- A calcined clay product used to quickly dry puddles and muddy conditions
- The finer gradation has more surface areas to dry the field faster, reducing rain delays
- It will not stick to cleats and is easily incorporated into the infield
- 50 lb. bags/40 bags per pallet

DPROCCDATX \$829.99 PALLET



### RED INFIELD CONDITIONER

- A vitrified clay (expanded shale and clay) product applied to skinned areas of baseball and softball fields
- Red infield conditioner helps create a natural look that enhances the appearance of an infield
- 50 lb. bags/40 bags per pallet
- Bulk delivery is available upon request

DPROICTX \$739.99 PALLET

## TURFACE ATHLETICS

SOLD BY THE PALLET // CALL FOR FREIGHT QUOTE

### TURFACE MVP

- Maintain a smooth, cushioned playable surface
- Excellent for incorporating into infield mix, topdressing to create a consistent and level playing surface.
- Fight infield compaction that leads to running, sliding and bad hop injuries
- Ideal for new infield construction or renovation
- 50lb bags/ 40 bags per pallet



1459334 \$779.99 PALLET

### 5 STAR PACKING CLAY

- Clay-silt mixture bonds quickly and packs tightly to help streamline installation
- Highly durable, long lasting performance and wear resistance
- Suitable for all levels of play
- Premium mound and plate clay that holds up to all of play
- 50lb bags/ 40 bags per pallet



1459335 \$747.99 PALLET

### QUICK DRY

- Absorbs its weight in water
- Will not harden or cake like similar water absorbing products
- Used for quickly drying up puddles and mud on skinned infields
- Rake in to make the field safe and playable
- 50lb bags/ 40 bags per pallet

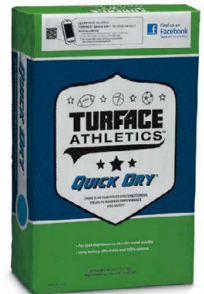

1459336 \$599.99 PALLET

### PRO LEAGUE ELITE-HERITAGE RED

- Creates superior sliding and fielding surfaces
- Remains consistent color in wet or dry conditions
- Ideal top dressing material for skinned infields
- 50lb bags/ 40 bags per pallet



1459337 \$799.99 PALLET

### PRO LEAGUE ELITE-NATURAL

- Designed for ultimate fielding and sliding surfaces
- Outstanding drainage and absorption qualities for maximum rain out protection
- Designed for increase safety and playability for all levels
- 50lb bags/ 40 bags per pallet



1459338 \$699.99 PALLET

### MOUNDMASTER BLOCKS

- 100% pure virgin clay blocks deliver long lasting performance
- Blocks are sized perfectly for building boxes and the mound from the ground up
- Packaged in 8 block sets in air tight bags to retain proper moisture
- Blocks are 2 1/4" x 4" x 8"
- 500 bricks per pallet



1459339 \$929.99 PALLET



### 4-WHEEL LINE MARKERS W/ PNEUMATIC TIRES

- The most durable line marker on the market
- 11 gauge steel frame
- 18 gauge galvanized steel bucket
- Tires measure 3.5"W x 10"D
- Easily adjustable to either 2" or 4" lines

**18 Month Limited Warranty**

<b>1. BBHDDM10</b>	100 lb. Capacity	<b>\$669<sup>99</sup></b> EA ★
<b>2. BBHDDM50</b>	50 lb. Capacity	<b>\$609<sup>99</sup></b> EA ★

### 4-WHEEL DRY LINE MARKER

- All steel construction
- 4 hard rubber wheels for extra durability
- Easily adjustable to either 2" or 4" lines

<b>3. BBDLM654</b>	4-Wheel 65 lb. Capacity	<b>\$479<sup>99</sup></b> EA ★
--------------------	-------------------------	--------------------------------

### 2-WHEEL DRY LINE MARKER

- All steel construction
- 2 hard rubber wheels for extra durability
- Easily adjustable to either 2" or 4" lines

<b>4. BBDLM252</b>	2-Wheel 25lb. Capacity	<b>\$329<sup>99</sup></b> EA ★
--------------------	------------------------	--------------------------------



### STREAMLINER 354 DRY LINE MARKER

- Heavy duty steel design
- Flexible brush agitator to improve chalk flow
- Smoother tracking for straighter, more consistent lines
- One button retractable handle for easy storage

<b>1459373</b>	35lb Capacity	<b>\$729<sup>99</sup></b> EA
----------------	---------------	------------------------------



### DURASTRIPE MARKING PAINT

- 20oz cans with 18oz by volume
  - Non-clogging, cans will empty completely
  - Safe for user, environment and all varieties of grass
  - Extremely durable, will not wash away with rain and elements
  - Aerosol cans come standard with a custom "T" spray for a crisp, wide athletic field lines
- Color Options: **Colt Gray, Dark Blue, Lite Brown, Lt Purple, North Carolina Blue, Team Gold, Turf Green, Aluminum, Black, Brown, Burgundy, Burnt Orange, Cardinal, Clear, Columbia Blue, Forest Green, Gold, GRAY, Green, Maroon, Navy, Orange, Pink, Purple, Red, Royal, Tan, Teal, Team Orange, Vegas Gold, White, Yellow.**

1460342 Case of 12 Cans-Specify Color **\$84<sup>99</sup>** CASE ★

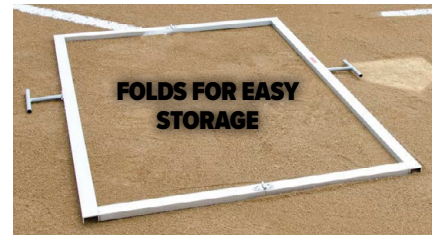

### FOLDABLE BATTER'S BOX TEMPLATES

- Lightweight aluminum frame template
- Simply line the handle up with the straight side edge of the plate and you will be square and the correct distance away from for proper alignment
- Step on template and leave a 2" W impression to chalk over
- Folds in half for easy transport

<b>BBTMPL46</b>	4' x 6' Baseball	<b>\$479<sup>99</sup></b> EA ★
<b>BBTMPL37</b>	3' x 7' Softball	<b>\$479<sup>99</sup></b> EA ★
<b>BBTMPL36</b>	3' x 6' Little League	<b>\$459<sup>99</sup></b> EA ★

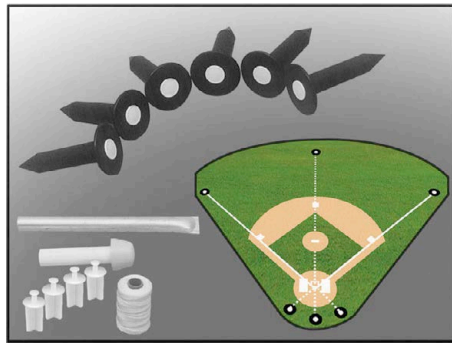

### BASEBALL FIELD LINING KIT

- The essential kit to properly line all baseball or softball fields
- Provides 6 ground sockets to establish perimeter and midfield locations and hold game day markers
- Kit includes: 6 sockets with plugs, 4 lining pegs, pilot hole tube and socket setter

**MKBLP6** **\$149<sup>99</sup>** EA

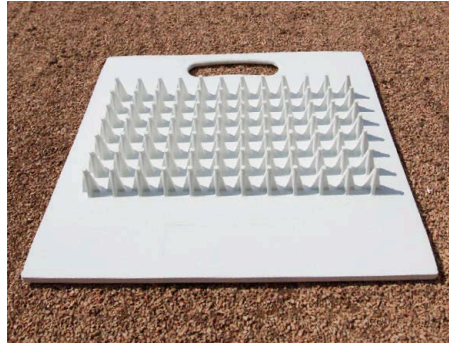

### CLEAT AND SPIKE CLEANER

- Durable molded PVC construction
- UV protected to withstand outdoor conditions
- Extended side panel
- Built in handle for easy transport

**1186796** 19" x 14" **\$99<sup>99</sup>** EA ★



### STRIPING MACHINE WITH 10' WHEELS

This striping machine is perfect for everyday field striping. It's 10" diameter wheels make for a smooth roll and less effort.

1460691 **\$239<sup>99</sup>** EA ★



### STRING WINDER - PRO CORD

- Braided thick cotton string line
- High impact plastic reel

1459374 500' Cord **\$99<sup>99</sup>** EA

**COACH'S CHOICE**



**TAMP**

- Tamp base is made of 1/2" thick steel plate
- Covers a 12" x 12" area
- Heavy duty 48" steel handle

**BBTAMPBM**

**\$159<sup>99</sup> EA ★**

**TAMP COVER**

- Designed to make tamping wet clay a simple, hassle free process as the cover does not allow wet dirt to stick to the tamp plate.
- Fits 12" x 12" tamp.

**1088137DS**

**\$75<sup>99</sup> EA**



**THREE-ROW MONSTER BROOM**

- 7' broom is excellent for dressing softball or baseball infields
- May also be used for sweeping warehouse floors, tennis courts and pavement
- Made with heavy-duty aluminum construction

**BBDRGBRM**

**\$329<sup>99</sup> EA**



**BEACON ATHLETICS SWEET SPOT TAMP**

- 4 interchangeable heads for accurate coverage
- Extra 5.5" handle to help reduce/eliminate vibration
- Great for groundskeepers and landscapers

<b>1459375</b>	Tamp Handle Only	<b>\$114<sup>99</sup></b> EA
<b>1459376</b>	4" x 6" Head Only	<b>\$69<sup>99</sup></b> EA
<b>1459377</b>	6" x 6" Head Only	<b>\$79<sup>99</sup></b> EA
<b>1459378</b>	8" x 8" Head Only	<b>\$89<sup>99</sup></b> EA
<b>1459379</b>	10" x 10" Head Only	<b>\$99<sup>99</sup></b> EA



**INFIELD LIP BROOM**

- Heavy duty 28" broom head with two rows of replaceable bristles and 5' powder-coated aluminum handle, bent to reduce back strain
- Ideal for brushing top-mix out of turf
- Use back side to scrape and break-up hard dirt

**1148497**

Size - 28"W

**\$189<sup>99</sup> EA**



**SUPER SOPPER**

- Pick up water & carry it away from playing surface
- For grass, tennis courts or artificial turf

**BBSSMCKR**  
**BBSSDLPH**

7 gallon holding tank  
14 gallon holding tank

**\$1,229<sup>99</sup> EA**  
**\$1,549<sup>99</sup> EA**



**BEACON ATHLETICS**

**COCOA INFIELD FINISHING MOPS**

- Designed for those small areas-impossible to finish grooming
- Great for pitching mounds, batters boxes, base paths and on-deck circles
- Heavy-duty reinforced aluminum.

**1091526**

2'W x 18"D

**\$239<sup>99</sup> EA**



**BEACON ATHLETICS**

**PUDDLE SPONGE**

- Sponge is built to last through several seasons of use.
- Absorb puddles, squeeze out the puddle water in a grassy off-field area and then hang to dry.

**1459387**

Set of 3

**\$129<sup>99</sup> EA**

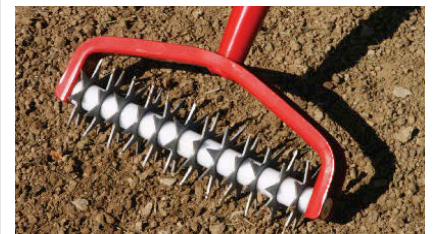

**OVERSEED ENHANCING TOOL**

- 12 self-sharpening steel star wheels penetrate any compacted soil
- Perfect for overseeding wear areas on your field
- Creates excellent seed-to-soil contact, critical for successful germination
- 9"W head w/60" steel handle.

**1149012**

**\$169<sup>99</sup> EA ★**



**DOUBLE PLAY INFIELD RAKE**

- Short teeth break up the hard clay
- Longer teeth sift the top soil for general grooming

<b>1234985</b>	Size - 24"W	\$169 <sup>99</sup> EA ★
<b>1234992</b>	Size - 36"W	\$179 <sup>99</sup> EA ★



**LEVELING BOARD**

- 54" width
- Ideal for levelings infield, bases, home plate & pitchers mound
- Leaves smooth finish on wet or dry field
- Heavy duty aluminum handle
- Steel cutting edge for filling high & low spots.

<b>1149005</b>		\$229 <sup>99</sup> EA ★
----------------	--	--------------------------

**COACH'S CHOICE**

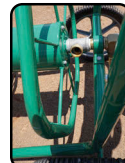

**ENDURO HOSE REEL SYSTEM**

- Heavy duty, powder coated steel construction
- Large 14" solid rubber wheels for smooth transport
- Includes a 1" x 6'L supply line hose
- Accommodates 150' of 1" hose
- Complete kit includes: Enduro Hose Reel, 1" x 100' Quick Wet Down Water Hose (1275179) and the 1" Aluminum Spray Nozzle (1237108)

<b>MSHREEL2</b>	Hose Reel Only	\$479 <sup>99</sup> EA ★
<b>K35559</b>	Complete Kit	\$669 <sup>99</sup> EA



**PRO 1" SPRAY NOZZLE**

- Aluminum design
- Adjustable from mist to stream
- Up to 35 GPM (gallons per minute)

<b>1237108</b>	Aluminum Spray Nozzle-Fits 1" hose	\$229 <sup>99</sup> EA
----------------	------------------------------------	------------------------

**JOX BOX**

(PHOTOS SHOW JOX BOX PRIOR TO INSTALLATION)

Eliminates holes in batter's boxes, in pitcher's area, and in front of bases. After proper installation, the Jox Box is low maintenance. Durable design resists steel cleats and is waterproof. Your field material is brushed into surface after installation to create a smooth transition. All are shipped motor freight.

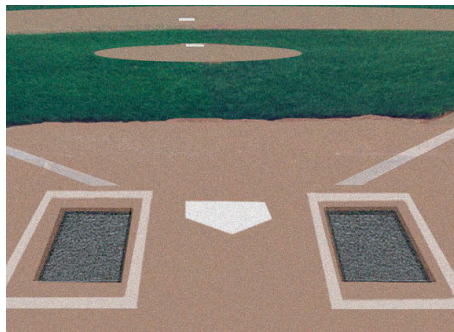

**BATTERS BOX FOUNDATION**

- Recycled rubber mats
- Eliminates deep holes in box areas
- Bury under 3" - 4" of dirt or clay
- Sold in pairs

<b>MK3240</b>	Size - 32"L x 40"W x 3/4"D	\$529 <sup>99</sup> PR
---------------	----------------------------	------------------------



**BATTERS BOX**

- Eliminates holes in batters boxes, in pitcher's area, and in front of bases
- After proper installation, the Jox Box is low maintenance
- Durable design resists steel cleats and is waterproof
- Size is 4' x 8' overall, 3' x 7' exposed after installation

<b>1235814</b>	Set of 2	\$1,949 <sup>99</sup> PR
----------------	----------	--------------------------

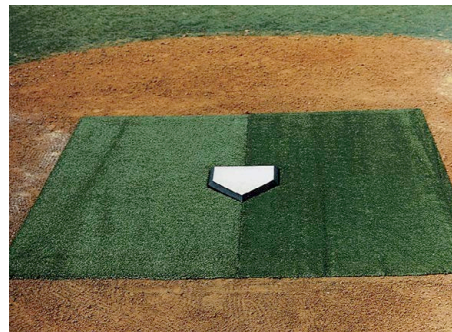

**DELUXE BATTERS BOX**

- Covers the entire homeplate area with a cut-out for homeplate
- Made in 2 pieces that butt together when installed

<b>1235838</b>	Youth Size 7' x 9' - Weight: 550 lbs	\$2,029 <sup>99</sup> EA	
<b>1235821</b>	Full Size 8' x 10' - Weight: 550 lbs	\$2,329 <sup>99</sup> EA	

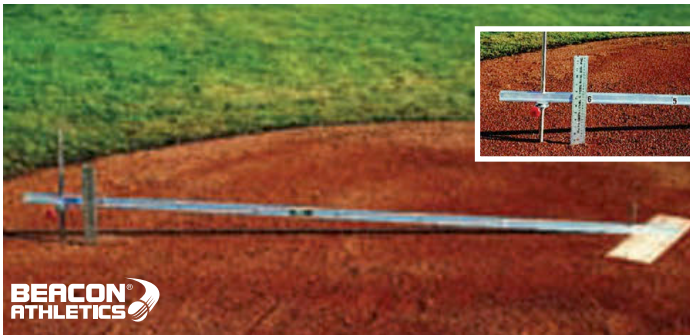

### MOUND SLOPE GAUGE

- This popular mound building tool is the most accurate way to ensure proper height and taper
- Includes bubble level, metal ruler, 2 support rods and complete instructions for mound construction and maintenance

1148992

\$379<sup>99</sup> EA



### PRO SHOT HOSE NOZZLE

- Flush setting to clear small particles from becoming lodged
- Easily adjusts from fine to blast spray

1459380

Fits 1" hose

\$599<sup>99</sup> EA



### GH FIELD HOSE

- Designed to increase working pressure up to 150psi
- Smooth PVC inner tube
- Ozone and ultraviolet resistant

1459381	50'	\$219 <sup>99</sup> EA
1459382	100'	\$339 <sup>99</sup> EA



### ULTRALITE FIELD HOSE

- Fits 1" nozzle
- Abrasion resistant poly cover
- Working pressure is 300psi

1459383	50'	\$299 <sup>99</sup> EA
1459384	100'	\$469 <sup>99</sup> EA



### PRO FLEX HOSE

- Fits 1" nozzle
- Long shank machine brass fitting
- Working pressure up to 150psi

1459385	50'	\$299 <sup>99</sup> EA
1459386	100'	\$434 <sup>99</sup> EA

### GRATE GUARDS

- Cover your hazardous drainage grates and utility boxes with non-skid, recycled rubber covers
- Water flows through; approximately 3/4" thick
- Color: Dark Green only

1170467

Square Grate Guard - 37" x 37"

\$289<sup>99</sup> EA



### COACH'S CHOICE



### ALUMINUM MAINTENANCE RAKE

- All aluminum construction
- Durable and lightweight with oversized teeth for easy field grooming & pit maintenance
- Use one side to rake and the other side to level
- 58" long handle

1196238	Size - 24"W	\$109 <sup>99</sup> EA ★
1196245	Size - 36"W	\$124 <sup>99</sup> EA ★
1196252	Size - 48"W	\$132 <sup>99</sup> EA ★

**BEST SELLER**

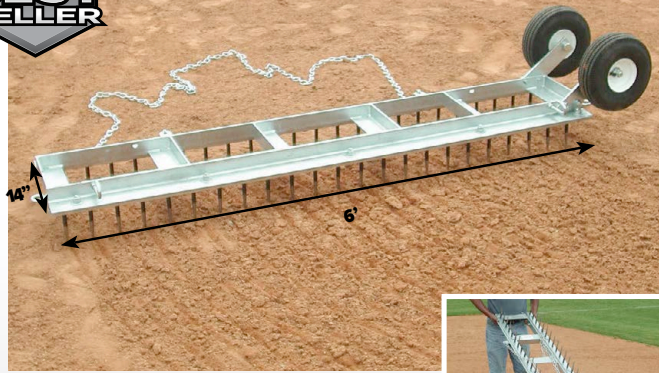

**DIAMOND DIGGER FIELD GROOMER**

- Hot dipped galvanized steel frame
- Uses 4.5" sharpened and hardened steel cutting teeth
- No-flat wheels allow you to roll for transport
- Pull chain is provided
- Hooks on rear allows for attachment of drag mat
- Remove wheels to turn groomer over and use as a leveling sled
- Recommended to be pulled by a tractor



<b>BSDDRAG</b>	Diamond Digger w/Wheels, Wt 100 lbs.	\$929 <sup>99</sup> EA ★
<b>BSDDWHL</b>	Set of 2 Wheels	\$289 <sup>99</sup> EA ★
<b>ZBDNAIL</b>	Repl. Teeth for Diamond Digger	\$189 <sup>99</sup> PACK ★

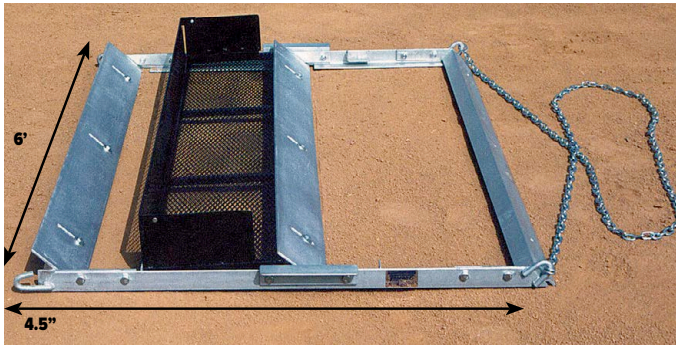

**CUT N' LEVEL DRAG**

- The Cut-N-Level drag is designed for grooming the surface of playing fields
- Features flat steel cutting blades and a screen for rock removal
- Made from 16 gauge metal, the cutting blades are slotted and attached to the main frame with bolts, allowing the operator to adjust the blades for the desired depth of cut
- Used in routine maintenance, the Cut-N-Level drag can be used for rock removal, smoothing and leveling the field as the need arises, saving hundreds of man-hours normally needed to do these jobs
- Frame and blades are galvanized
- Weight: 220 lbs.

<b>BSCLDRAG</b>	Size - 6'W x 4'6"L	\$1,499 <sup>99</sup> EA ★
-----------------	--------------------	----------------------------



**BUY THE COMBO AND SAVE!**

**DIAMOND DIGGER FIELD GROOMER - COMBO**

- Purchase the Diamond Digger together with our Heavy Duty drag mat (1149821) and save

<b>BSDDRAG</b>	Complete Combo	\$1,129 <sup>99</sup> EA ★
----------------	----------------	----------------------------

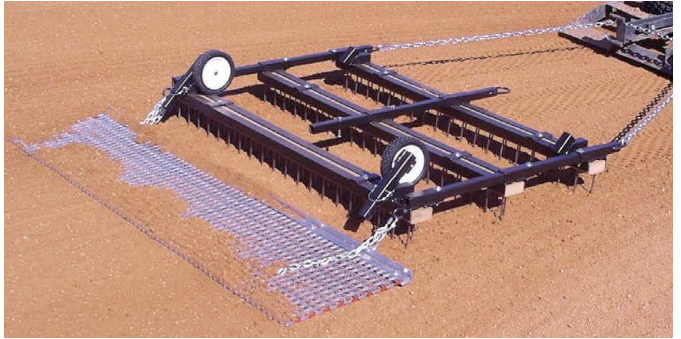

**5' X 3' PREMIUM NAIL DRAG**

- Welded steel frame supports 117 - 6"L x ¼"D grooming nails
- Wheels and tongue make moving and storing these units easy
- Comes complete with 6'W x 18"L rigid drag mat
- All attachments, hardware and pull chains are included
- Frame size 5' x 3'. Weight: 120 lbs.

<b>BS53DRAGC</b>	Nail Drag w/ Rigid Drag Mat (shown)	\$1,349 <sup>99</sup> EA ★
<b>BS53DRAG</b>	Nail Drag w/ Drag Chain only	\$1,079 <sup>99</sup> EA ★
<b>BSNAILPK</b>	Replacement Nails (pack of 117)	\$114 <sup>99</sup> EA

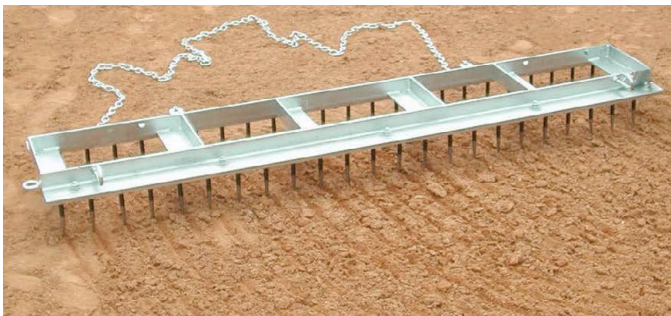

**BIG LEAGUE FIELD DRAG**

- Designed to break up dirt or cinders on the baseball field or track
- Features forty-six 4.5" steel cutting teeth
- Frame is hot dipped galvanized steel
- Heavy duty pull chain included
- Recommended to be pulled by a tractor
- Grooming drag chain included
- Flip over and use as leveling drag
- Weight : 88 lbs.

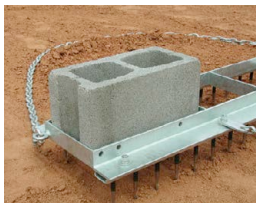

<b>BSDRAG</b>	Size - 14"W x 6'L	\$729 <sup>99</sup> EA ★
---------------	-------------------	--------------------------



**NEW STRIPE**

**DIRT MEDIC WITH BRUSH**

- Break-up packed surface and level ridges and ruts
- Can be towed with garden tractors, ATV's or light utility vehicles
- Weighs less than 200lbs.
- Teeth may be completely raised to use just the blade and/or broom

<b>1378377</b>	32"W x 62"L x 36"H	\$3,299 <sup>99</sup> EA
----------------	--------------------	--------------------------

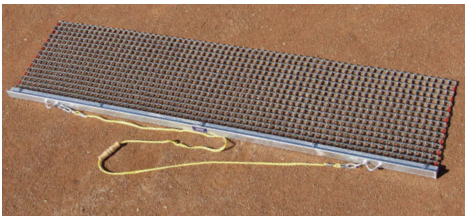

### RIGID DRAG MATS

- Rugged all-steel drag mats have 1" x 1" mesh with 13 gauge galvanized connecting rods
- Mesh material is 3/8" x .050 galvanized steel
- Cannot be rolled up for storage
- Includes heavy-duty angle iron across front of mat and a rope with handle for pulling

<b>DMATR6X3</b>	6'W x 3'L, Wt: 44 lbs.	<b>\$529<sup>99</sup></b> EA ★
<b>DMATR6X18</b>	6'W x 18"L Weight: 35 lbs.	<b>\$379<sup>99</sup></b> EA ★
<b>DMATR4X3</b>	4'W x 3'L, Weight: 36 lbs.	<b>\$409<sup>99</sup></b> EA ★
<b>DMATR4X18</b>	4'W x 18"L Weight: 24 lbs.	<b>\$349<sup>99</sup></b> EA ★

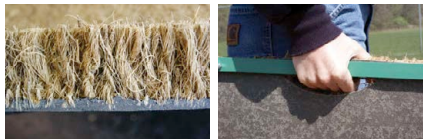

### COCOA DRAG MATS

- Constructed from natural cocoa fibers that "float" across the surface producing a beautiful finish with minimal buildup of your infield mix
- Solid-steel twin blade cutting edge to level rough spots
- Great on turf to break up core aeration plugs and smooth in top-dressing materials
- Handle grip for easy transport

<b>1091540</b>	Standard Cocoa Drag - 4' x 2'	<b>\$519<sup>99</sup></b> EA
<b>1091557</b>	Large Cocoa Drag - 6' x 2'	<b>\$444<sup>99</sup></b> EA
<b>1091564</b>	Jumbo Cocoa Drag - 6' x 4'	<b>\$749<sup>99</sup></b> EA

### 6' CUTTING BAR (WITH DRAG)

- Unique 6' asymmetrical cutting bar levels & smooths rough spots and eliminates ridge build-ups
- The cutting bar is sized to match our 6' x 6' drag mats
- Includes quick-link attachments
- Combo unit includes cutting bar and 6' x 6' drag (DMAT6X6)



<b>1237009</b>	Cutting Bar only	<b>\$369<sup>99</sup></b> EA
<b>1273410</b>	Cutting Bar w/drag combo	<b>\$819<sup>99</sup></b> EA ★



### HAND NAIL DRAG

- Ideal for scarifying baselines, cutouts and home plate areas, as well as daily nail dragging of infield skin
- Constructed of plastic lumber and hardened 1/4" steel spikes and can be pulled in either the 3'W or 2'W direction by simply changing the tow rope connection point
- Pull rope included

<b>1236996</b>	Size - 3' x 2'	<b>\$719<sup>99</sup></b> EA
----------------	----------------	------------------------------

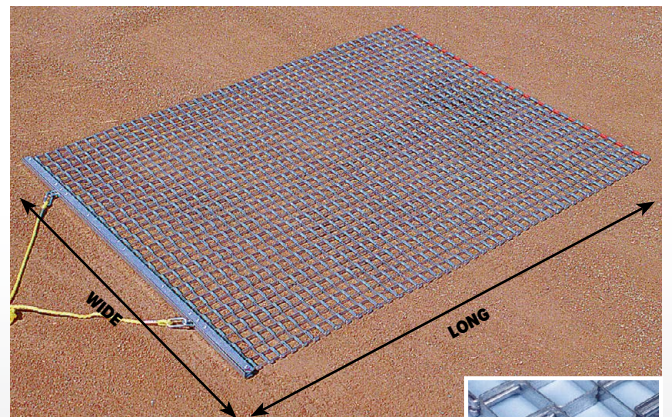

### ALL-STEEL DRAG MATS

- Workhorse, all-steel drag mat comes complete with drag bar and pull rope
- Mesh material is 3/8" x .050 galvanized steel
- Perfect for general grooming and maintenance

<b>BBMAT35X</b>	Size - 3'W x 5'L - Weight: 28lbs.	<b>\$299<sup>99</sup></b> EA ★
<b>1200423</b>	Size - 3'W x 4'L - Weight: 23lbs.	<b>\$269<sup>99</sup></b> EA ★
<b>1200430</b>	Size - 6'W x 3'L - Weight: 38lbs.	<b>\$399<sup>99</sup></b> EA ★
<b>BBMAT66X</b>	Size - 6'W x 6'L - Weight: 64lbs.	<b>\$569<sup>99</sup></b> EA ★
<b>BBMAT106</b>	Size - 10'W x 6'L - Weight: 97 lbs.	<b>\$679<sup>99</sup></b> EA ★ 

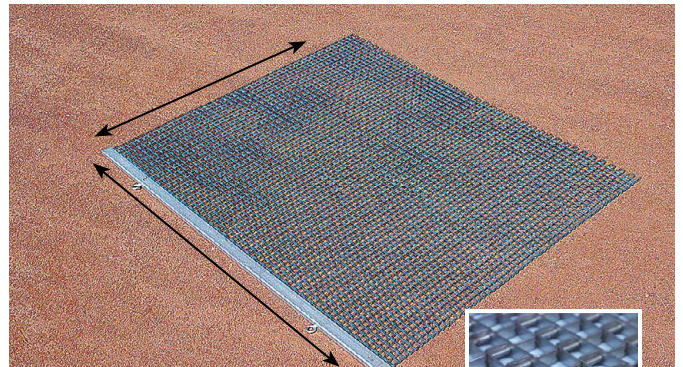

### MONSTER DRAG MAT

- Deluxe mat construction utilizes 1/2" x .062 mesh with 6 gauge connecting rods, each welded on end
- Includes angle iron front with welded eye bolts to attach your chain

<b>1159608</b>	Size - 6'W x 4'L	<b>\$699<sup>99</sup></b> EA ★
----------------	------------------	--------------------------------

### COACH'S CHOICE

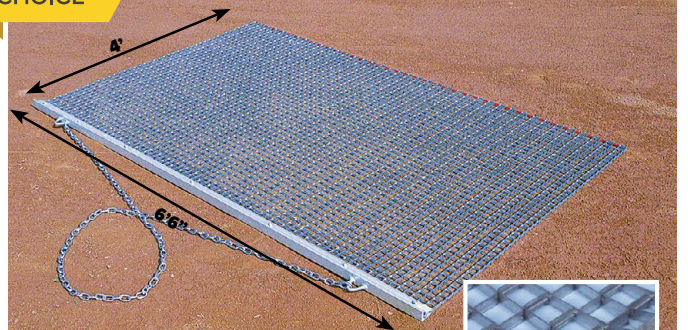

### HEAVY DUTY DRAG MAT

- Mesh is 3/8" x .050 galvanized steel
- Includes heavy duty angle iron across front of mat and a heavy duty chain for tractor pulling
- Weight: 68 lbs.

<b>1149821</b>	Size - 6'6"W x 4'L	<b>\$629<sup>99</sup></b> EA ★
----------------	--------------------	--------------------------------

## PITCHERS PLATES

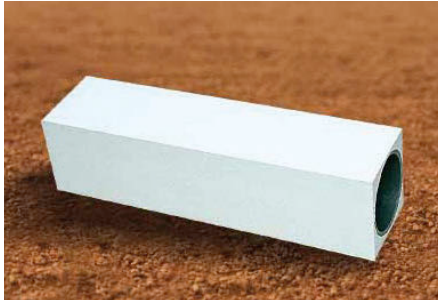

### 4-WAY PITCHER'S RUBBER

- Comes complete with inner support tubing
- Designed to be rotated periodically for extended life

<b>BBPR4WAY</b>	Official Size - 6" x 24"	<b>\$192.99</b> EA ★
<b>BBPR4YTH</b>	Youth Size - 4" x 18"	<b>\$164.99</b> EA ★

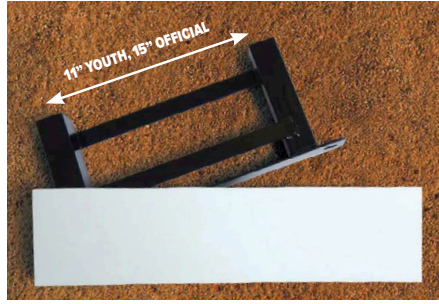

### REMOVABLE PITCHER'S PLATE & ANCHOR

- Semi-permanent anchoring system
- Powder coated steel stanchion bolted to the pitcher's rubber

<b>BSIGPPSR</b>	Complete Set - Official Size 6" x 24"	<b>\$92.99</b> EA ★
<b>1033434</b>	Official Ground Anchor w/ Insert	<b>\$49.99</b> EA ★
<b>1033465C</b>	Complete Set - Youth Size 4" x 18"	<b>\$72.99</b> SET ★
<b>1033441</b>	Youth Ground Anchor w/ Insert	<b>\$54.99</b> EA ★



### PROFESSIONAL REMOVABLE PITCHING RUBBER

- All steel ground anchor to be cemented into ground
- Pitcher's rubber is bolted and silicone-sealed to the top stanchion
- Comes with two rubber anchor plugs and an anchor digout tool

<b>BSPIGP</b>	Official Size - 6" x 24"	<b>\$339.99</b> SET ★
---------------	--------------------------	-----------------------



### PITCHER'S RUBBER

- Solid white molded rubber
- Includes three metal spikes

<b>BBPPLATE</b>	Official Size - 6" x 24"	<b>\$64.99</b> EA ★
<b>BBPPLLXXY</b>	Youth Size - 4" x 18"	<b>\$42.99</b> EA ★

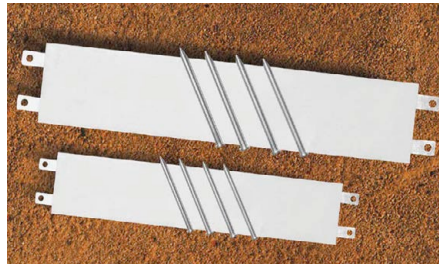

### END SPIKED PITCHING RUBBERS

- Spikes go through steel tabs for easy installation
- Includes 4 spikes

<b>1147902</b>	Official Size - 6" x 24"	<b>\$64.99</b> EA ★
<b>1148466</b>	Youth Size - 4" x 18"	<b>\$39.99</b> EA ★
<b>1148473</b>	Extra Hammer Spikes	<b>\$22.99</b> PACK OF 4 ★



### STEP DOWN PITCHER'S RUBBER

- Wooden core with solid molded cover and front extension to prevent holes in the front of the plate and reduce maintenance
- No stakes or spikes required

<b>BBPRPROX</b>	Official Size - 6" x 24"	<b>\$147.99</b> EA ★
<b>BBPRPROY</b>	Youth Size - 4" x 18"	<b>\$119.99</b> EA ★

## HOME PLATES

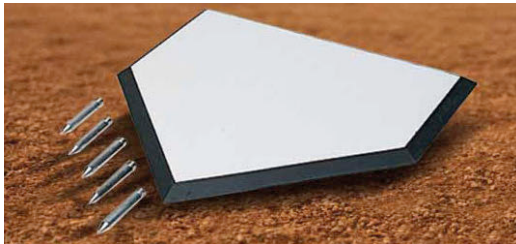

### RUBBER HOME PLATE

- Solid white rubber with black beveled edges for safety
- Includes 5 spikes

<b>BBHPXXXXY</b>		<b>\$72.99</b> EA ★
<b>BBHPSPIK</b>	Replacement Spikes	<b>\$19.99</b> SET OF 5 ★

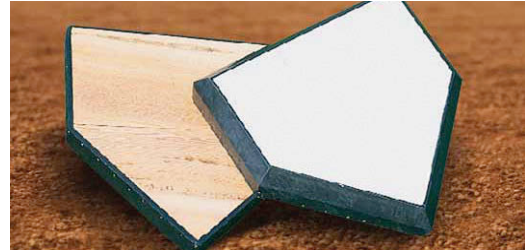

### WOOD-FILLED HOME PLATE

- Full traditional solid wood filling for superior durability
- Beveled edges and sides reduce chance of cleats catching

<b>BBHPSAFE</b>	<b>\$174.99</b> EA ★
-----------------	----------------------



### WAFFLE STYLE IN-GROUND HOME PLATE

- All rubber construction
- Waterproof with non-skid surface.

<b>BBHPSAFW</b>	<b>\$144.99</b> EA ★
-----------------	----------------------

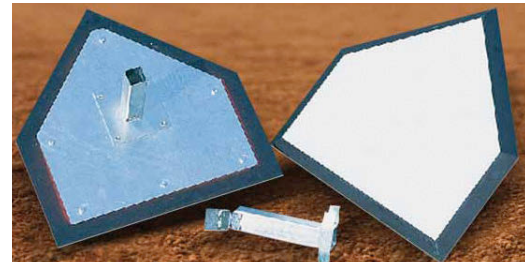

### MAJOR LEAGUE HOME PLATE

- Beveled hard white rubber plate
- Includes anchor

<b>BBHPHWOBBM</b>	<b>\$179.99</b> EA ★
-------------------	----------------------



## PRO BASES



### "BOLCO" STYLE STRAPLESS BASES

- Made from rugged, bonded polyester padding that is tear-resistant and waterproof
- The base is easily bolted to its anchor plate
- Anchor plate contains metal sleeve for stability
- Base size - 15"L x 15"W x 3"H

<b>BBBASEOP</b>	Set - 3 Bases, 3 Stakes & 3 Plugs	<b>\$329<sup>99</sup></b> SET ★
<b>BBBASEBO</b>	Set - 3 Bases & 3 Stakes	<b>\$269<sup>99</sup></b> SET ★
<b>BBBOSPIK</b>	Base Ground Stakes	<b>\$18<sup>99</sup></b> SET ★

## REC BASES

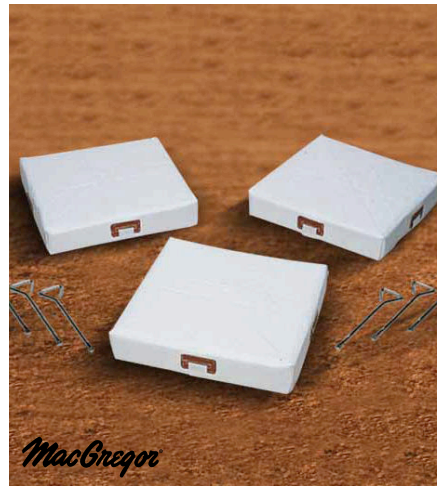

### HEAVY DUTY VINYL BASES

- Inverted sewn seams for extra durability and double-thick-top for long lasting wear
- Outer cover is 100% nylon-impregnated vinyl
- Polyfoam inner core for maximum shape retention
- Packed 3 bases per set with 6 spikes

<b>MCBASE55Y</b>	Official Size - 15" x 15"	<b>\$114<sup>99</sup></b> SET ★
<b>MCBASE35Y</b>	Youth Size - 14" x 14"	<b>\$94<sup>99</sup></b> SET ★
<b>BBSPIKES</b>	Replacement Spikes	<b>\$42<sup>99</sup></b> SET OF 6 ★



MacGregor



### MAJOR LEAGUE BASES

- Heavy gauge white rubber cover over a high density foam interior and all welded steel stanchion pan - no bolts to come loose.
- This base is designed to reduce sliding injuries, it is not a substitute for proper sliding
- Base size - 15" x 15" x 3"

<b>BBBASEPR</b>	Set of 3 w/Ground Anchors	<b>\$324<sup>99</sup></b> SET ★
<b>BBBASEPX</b>	Set (3)- w/o Ground Anchors	<b>\$309<sup>99</sup></b> SET ★
<b>BBBASEPP</b>	Set (3)- w/Ground Anchors, Plugs	<b>\$389<sup>99</sup></b> SET ★
<b>1170757</b>	Single Base Only	<b>\$114<sup>99</sup></b> EA ★

## SAFETY BASES



**NOTE: even bases designed to reduce sliding injuries are not a substitute for using proper sliding techniques.**

### MAGNETIC SUPER BASE

LITTLE LEAGUE® APPROVED.

Reduce the risk of serious injury to sliding players with this unique base designed for all ages. According to Rule 1.06 of the Little League® rule book, Beginning in 2008, it has become mandatory that all leagues utilize bases that disengage their anchor.

Features:

- Bases release when the magnetic attraction between the base and magnetic fixture are overcome by excessive force from a short slide.
- 3 different plate sizes bolt to the bottom of the base pan to adjust the holding strength of the base to the anchor.
- Base cover has a ribbed surface design to reduce the risk of slipping.

<b>BBMMSBXX</b>	Complete Base - 15" x 15" x 3"	<b>\$339<sup>99</sup></b> EA ★
<b>Z7BBMAGFIX</b>	Magnetic Base Fixture	<b>\$269<sup>99</sup></b> EA ★
<b>1185829</b>	Replacement Base Cover and Pan	<b>\$139<sup>99</sup></b> EA ★
<b>BBANCHOR</b>	Ground Anchors - 3/Set	<b>\$79<sup>99</sup></b> SET OF 3 ★

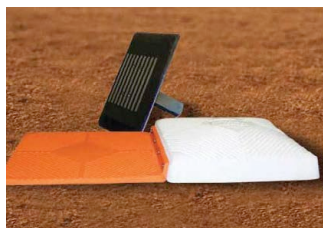

### MAGNETIC DOUBLE 1ST BASE

- Perfect addition for those who have magnetic type bases
- "White part" is attached to the magnetic stanchion conventionally leaving the safety orange base in foul territory
- "Orange part" is at ground level.

**1274127** **\$389<sup>99</sup>** EA ★



### SHOCK ABSORBING BASES

- This cushioned base is uniquely designed to help reduce injury
- The base gives at the right time to absorb the brunt of the slide
- Durable, one-piece molded rubber base with no metal parts - No rust!
- Removable white center post for easy storage and replacement.
- Does not include anchors

<b>BBBASRIC</b>	Complete Set without Anchors	<b>\$324<sup>99</sup></b> SET ★
<b>BBDFBSTN</b>	Replacement white center posts	<b>\$28<sup>99</sup></b> SET OF 3 ★

### COACH'S CHOICE



### GAME BASE CART

- Heavy-duty construction with 8" rubber tires
- Universal stems hold both 1" male and 1 1/2" female style bases
- Rubber grip handle

**1378676** Base Transport Cart **\$429<sup>99</sup>** EA ★

# Schutt HOLLYWOOD IMPACT KWIK RELEASE BASE

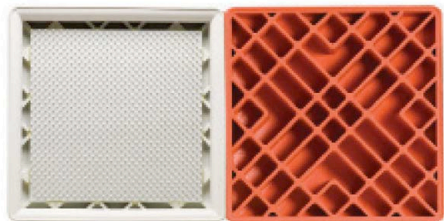

## DOUBLE FIRST BASE DESIGN

- Kwik-Release™ double first base disengages completely when enough force hits the base, but the orange base remains anchored to the ground
- Size - 15" x 15" x 2 1/4 - 2 3/4"
- Ground plugs and anchors sold separately

**K72709** Kwik-Release: Dbl. 1st + 2 Youth Bases **\$689<sup>99</sup>** SET

## HOLLYWOOD IMPACT QUICK RELEASE BASES

- Patented Kwik-Release design compresses & disengages the base from its orange platform upon impact
- Fully compliant with Little League Rule 1.06
- Base platform stanchion fits standard ground anchor
- Female ground anchors and plugs are sold separately
- Bases are 15" x 15" x 3" and come in two resistance levels - youth or varsity.
- Youth bases take 20 lbs of force for base to "release"
- Varsity bases take 32 lbs of force for base to "release"

**1274169**

Varsity Set of 3 Bases - Weight: 60 lbs

**\$449<sup>99</sup>** SET

**1274176**

Varsity Individual Base - Weight: 20 lbs

**\$499<sup>99</sup>** EA

**1274145**

Youth Set of 3 Bases - Weight: 60 lbs

**\$499<sup>99</sup>** SET

**K72468**

Youth Individual Base - Weight: 20 lbs

**\$499<sup>99</sup>** EA

**1236507**

Ground Anchors - 3/Set

**\$72<sup>99</sup>** SET



## SOFT TOUCH BASES

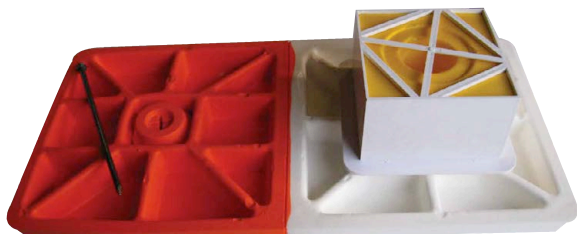

## SOFT TOUCH™ DOUBLE FIRST BASE

- White side anchored in ground mount, orange side anchored under the base with spikes.

**1236293** **\$709<sup>99</sup>** EA

Softtouch™ double first bases are not a release style base due to double ground anchors.



## SOFTOUCH™ PROGRESSIVE RELEASE BASE

- Designed to flex and absorb energy as a player slides into the base
- "Pops out" on the impact of short, hard slides
- Molded 7" stem fits over the orange play-plug and inside the ground mount

**1. BBBASBRE**

Complete 15" Single Base

**\$314<sup>99</sup>** EA

**2. BBBREMNT3**

Extra Ground Mounts - Set of 3

**\$99<sup>99</sup>** SET

**3. 20026504**

Extra Tapered Plugs - Set of 3

**\$189<sup>99</sup>** SET

**BBBASAYP**

Plugs (fills ground mounts) - set of 3

**\$489<sup>99</sup>** SET



## SOFT TOUCH CONVERTIBLE BASES

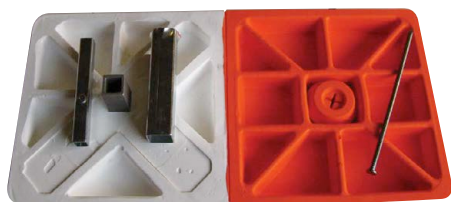

## SOFT TOUCH™ CONVERTIBLE DOUBLE 1ST BASE

- Non-release style base
- Anchors into two ground anchors (not included)
- Male or female style

**K13085** **\$549<sup>99</sup>** EA



## SOFTOUCH™ CONVERTIBLE BASES

- Designed to fit into your existing 1" male or 1-1/2" female ground anchors (ground anchors not included)
- Progressive release bases are designed to flex and absorb energy
- In the case of a short slide, the base is designed to pop free from its mount

**1236309** Set of 3 - 15" Bases with Mounting Tees **\$829<sup>99</sup>** SET



## SYNTHETIC TURF BASE

- Official size 15" x 15"
- Durable cut resistance polyurethane
- Bottom has a unique claw design that grabs the turf
- Does not require a mounting system

**1375580** Set of 3 **\$1,199<sup>99</sup>** EA  
**1375581** Single Base **\$649<sup>99</sup>** EA

## MacGregor **DOUBLE FIRST BASE**



### DOUBLE FIRST BASE

- One-piece molded rubber base
- No stitches to tear or rip
- Set includes 2 ground anchors for installation

**BBDFB3NR** 30"L x 15"W x 3"H \$289<sup>99</sup> EA ★

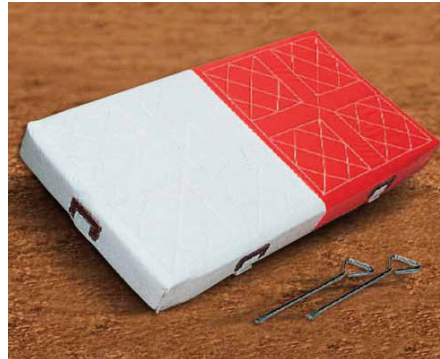

### RECREATIONAL DOUBLE FIRST BASE

- Designed to reduce the chances of collisions, spiking and injuries
- Heavy duty vinyl covering with soft rebounded foam filler
- Comes with 2 straps, 2 buckles and 2 spikes

**BBDBLFB3** Size - 30"L x 15"W x 3"H \$119<sup>99</sup> EA ★

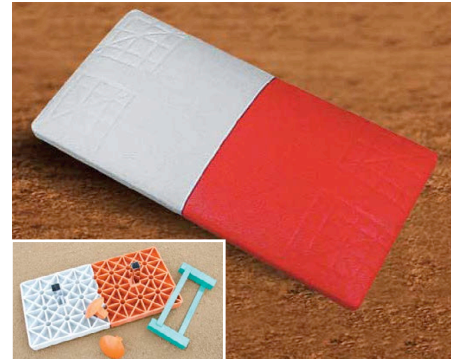

### PREMIUM DOUBLE FIRST BASE

- One piece molded rubber base with simulated quilted top and steel stanchions
- Size - 30"L x 15"W x 3"H
- Weight: 33 lbs.

**1235609** Set - Base, Anchor & Plugs \$409<sup>99</sup> EA ★  
**1235616** Repl. Anchor Only \$74<sup>99</sup> EA ★

## MacGregor **INDOOR/PE BASES**



### THROW DOWN BASES

- 5 piece orange rubber throw down home plate, pitcher's plate and three base set
- Ideal for both indoor and outdoor use
- Made of washable and flexible rubber

**1235623** \$39<sup>99</sup> SET ★

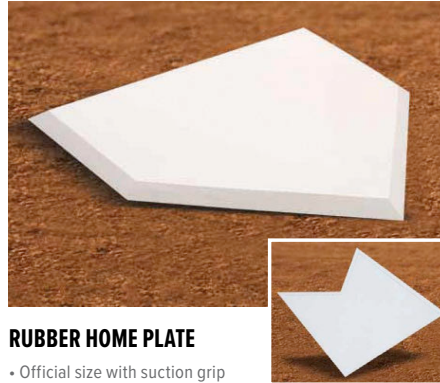

### RUBBER HOME PLATE

- Official size with suction grip underside for use indoor and out.
- Heavy duty white molded rubber
- No spikes

**BBSBHPXXY** Home plate only \$32<sup>99</sup> EA ★  
**BBSBHPEX** Home Plate Extension (17" x 13") \$52<sup>99</sup> EA ★

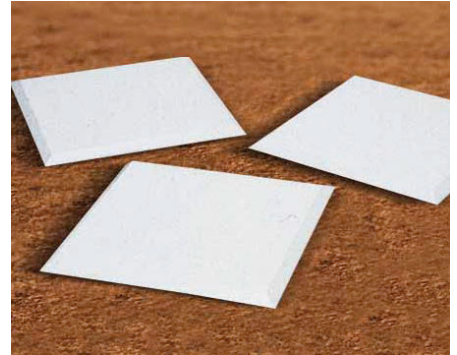

### RUBBER BASES

- Solid white, heavy duty molded
- Rubber throwdown bases with suction grip underside
- For use indoor and out

**BBSBBXXXY** Set of 3 \$77<sup>99</sup> SET OF 3 ★  
**BBSBBEACY** Single Base \$42<sup>99</sup> EA ★

## MacGregor **BASE ACCESSORIES**

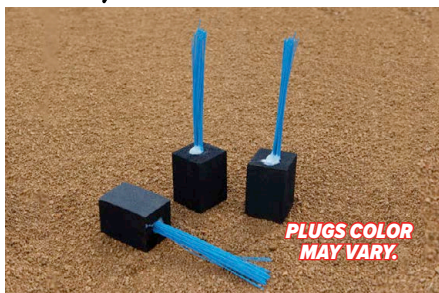

### BIG LEAGUE BASE PLUGS (3-PACK)

**BBBLPLUGPK** \$62<sup>99</sup> PACK



### ANCHOR CLEAN OUT TOOL

**BBDIGOUT** \$42<sup>99</sup> EA ★

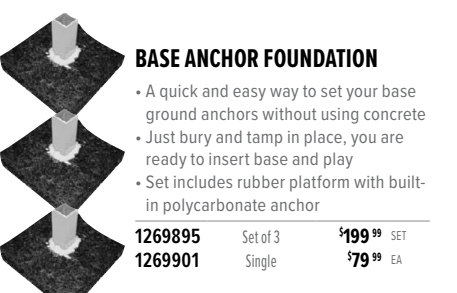

### BASE ANCHOR FOUNDATION

- A quick and easy way to set your base ground anchors without using concrete
- Just bury and tamp in place, you are ready to insert base and play
- Set includes rubber platform with built-in polycarbonate anchor

**1269895** Set of 3 \$199<sup>99</sup> SET  
**1269901** Single \$79<sup>99</sup> EA



### UNIVERSAL RUBBER ANCHOR PLUG

**BBRPLUGS** \$11<sup>99</sup> EA ★



### STANDARD GROUND ANCHORS

**BBANCHOR** \$79<sup>99</sup> SET OF 3 ★

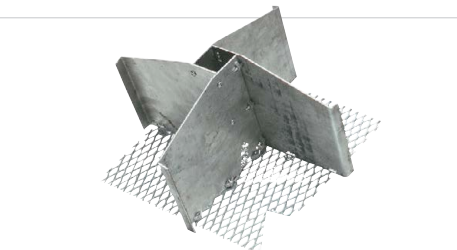

### HEAVY-DUTY BASEBALL/SOFTBALL BASE GROUND ANCHOR

**BBMNAANCH** \$52<sup>99</sup> EA ★

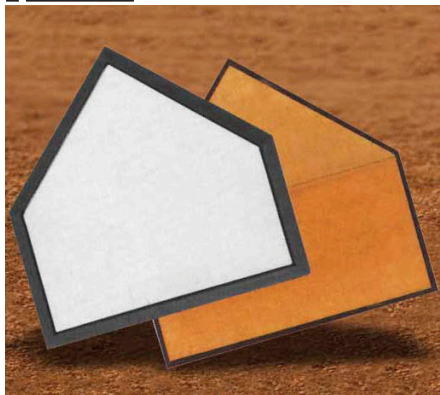

## BOLCO 300-AS WOOD HOME PLATE

- Quality vinyl cover over wood block filler
- Regulation size - 3" thick
- Weight: 29 lbs.

**1236415**

**\$164<sup>99</sup>** EA

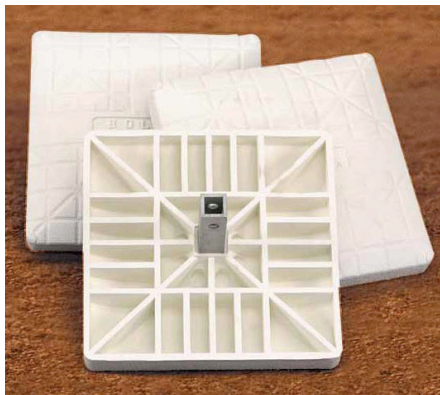

## ADAMS BOLCO 175-MLB MAJOR LEAGUE BASES (3-PACK)

- One piece all rubber construction with universal aluminum stanchion
- Will fit male or female ground anchor
- Ground anchors not included

**1236408**

Size -15" x 15" x 3"

**\$457<sup>99</sup>** SET

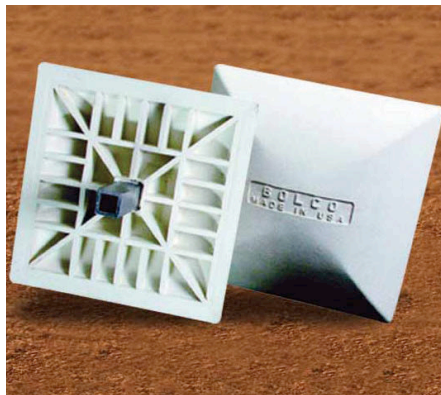

## BOLCO 150-SB SAFETY BASE

- One piece all rubber construction with universal aluminum stanchion.
- Tapered sides reduce the risk of injury
- Fits male or female ground anchors
- Ground anchors not included

**1196528**

**\$349<sup>99</sup>** EA

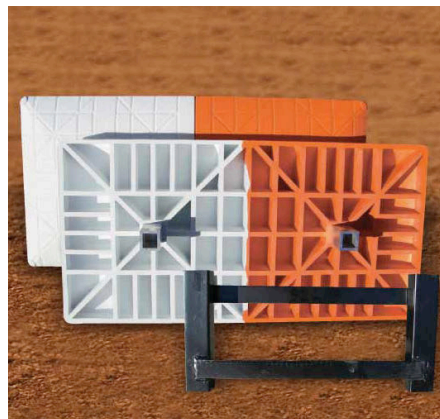

## BOLCO DOUBLE FIRST BASE

- One piece molded double base
- Will fit male or female ground anchor (not included)

**1196511**

Size -15" x 30" x 3"

**\$359<sup>99</sup>** EA

**1196535**

Double Ground Anchor

**\$99<sup>99</sup>** EA



## BOLCO 100-ML MAJOR LEAGUE BASES

- Bolt-on top plate design
- Official size 15" x 15" x 3"

**1236316**

Set of 3 Bases only

**\$277<sup>99</sup>** SET

**1236325**

3 Bases, Top Plates & Anchors

**\$289<sup>99</sup>** SET

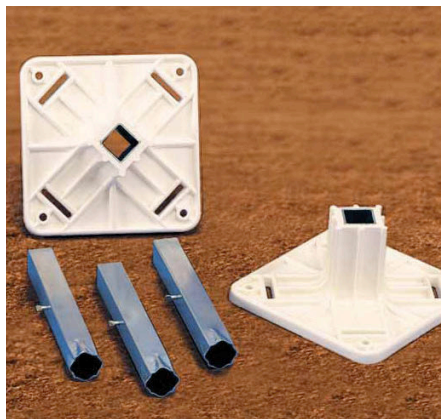

## ANCHOR TOP PLATE

- One female plastic top plate that fits over male anchor stakes

**1236347**

Bolco Anchor Top Plate

**\$42<sup>99</sup>** EA

**1236354**

Size - 1" x 1"

**\$27<sup>99</sup>** EA



## BOLCO 4-WAY PITCHER'S RUBBER

- Made of solid white rubber with PVC inner core
- Designed to be rotated to extend life

**1236361**

Official Size - 6" x 24"

**\$149<sup>99</sup>** EA

**1236378**

Youth Size - 4" x 18"

**\$129<sup>99</sup>** EA

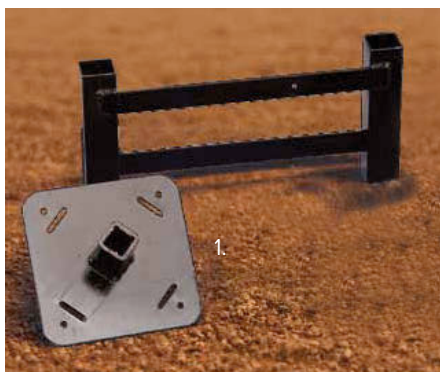

## 1. BOLCO 225-BAS ANCHOR GROUND STAKE

- One male ground stake for anchoring in concrete.

**1236354**

Size - 1" x 1"

**\$27<sup>99</sup>** EA

## 2. DOUBLE GROUND ANCHOR

- All steel - for double 1st base or pitcher's rubber

**1196535**

Double Ground Anchor

**\$99<sup>99</sup>** EA



## BOLCO STEP DOWN PITCHER'S RUBBER

- Step down pitcher's plate with traditional solid wood core and molded rubber cover
- Front extension prevents holes in front of plate and reduces mound maintenance
- No stakes or spikes required

**1236385**

Official Size - 6" x 24"

**\$137<sup>99</sup>** EA

**1236392**

Youth Size - 4" x 18"

**\$119<sup>99</sup>** EA

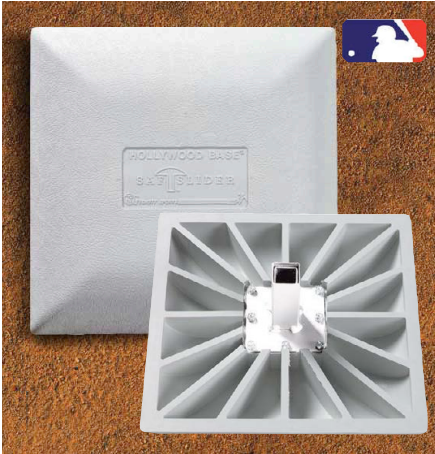

**HOLLYWOOD® SAF-T-SLIDER™ BASES**

- Unique beveled corners sit flush with the ground
- Durable, heavy-gauge rubber construction
- Ideal for youth and recreational softball play
- Ground anchors sold separately

**1036992** \$409<sup>99</sup> SET



**HOLLYWOOD IMPACT BASES**

- Constructed of high quality rubber with honeycomb design for flexibility and durability
- Base compresses as runner slides into it
- Replaceable steel stanchion fits the hollywood ground anchor (sold separately)

**1236439** Size - 15" x 15" x 2" \$452<sup>99</sup> SET

**COACH'S CHOICE**



**ORIGINAL HOLLYWOOD BASES®**

THE ORIGINAL JACK CORBETT™ BASES USED BY MAJOR LEAGUE BASEBALL SINCE 1939

- Major league base designed to provide greater strength and durability under constant usage.
- Tapered lip ground hugging feature reduces possibility of edge turn-up due to impact.
- Natural rubber cover with steel stanchion.
- Requires Hollywood ground anchors.
- Anchors and base plugs sold separately

**1036930** Size - 15" x 15" x 3" \$369<sup>99</sup> SET



**HOLLYWOOD 4-WAY PITCHER'S RUBBER**

- The most stable, rugged, 4-sided pitching rubber available
- Interior aluminum tube for maximum longevity when filled with dirt or concrete

**1236460** Official Size - 6" x 24" \$259<sup>99</sup> EA



**HOLLYWOOD IMPACT DOUBLE FIRST BASE**

- Constructed of high quality rubber with honeycomb design
- Base compresses as runner slides into it.
- Anchors and base plugs sold separately

**1236453** Base only \$299<sup>99</sup> EA

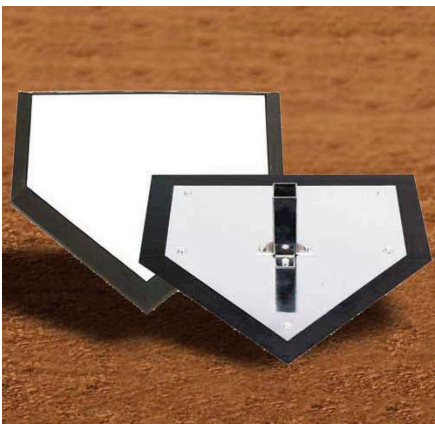

**HOLLYWOOD HOME PLATE**

- Stanchion mounted professional homeplate

**1236484** \$234<sup>99</sup> EA

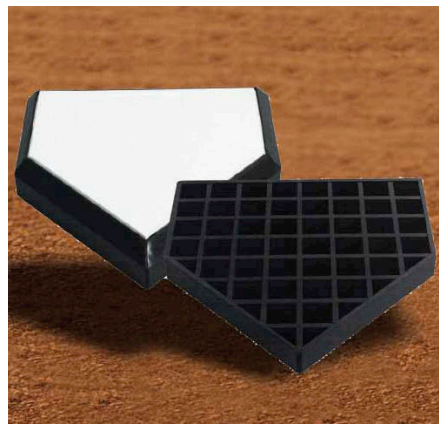

**HOLLYWOOD BURY-ALL HOME PLATE**

- High-durability, all rubber waffle design
- No corners or edges to catch spikes
- Non-skid rubber surface, waterproof

**1236477** \$239<sup>99</sup> EA



**ACCESSORIES**

- |                    |                        |                         |
|--------------------|------------------------|-------------------------|
| 1. <b>1236507</b>  | Ground Anchors - 3/Set | \$72 <sup>99</sup> SET  |
| 2. <b>BBRPLUGS</b> | Base Plugs             | \$11 <sup>99</sup> EA ★ |
| 3. <b>1236491</b>  | Anchor                 | \$76 <sup>99</sup> EA   |
| 4. <b>BBDIGOUT</b> | Dig-Out Tool           | \$42 <sup>99</sup> EA ★ |



### SINGLE WHEEL BB/SB PITCHING MACHINE

- Speed: 30-60 mph
- Throws baseballs, 11" and 12" softballs
- Runs on 110 volt AC or generator 1/4 HP D.C. motor
- Durable urethane wheel eliminates air pressure issues
- Heavy duty legs are convertible for baseball or softball

<b>BBDOG1XX</b>	Complete Unit	<b>\$1,349<sup>99</sup></b> EA ★
<b>BBDOG1WL</b>	Replacement Wheel	<b>\$439<sup>99</sup></b> EA ★

### ELITE 2 WHEEL PITCHING MACHINE

- Throws curves, fastballs, sliders, sinkers and knuckleball
- Can throw pop-ups as well as grounders
- Pitch speed between 30 - 102 mph
- Urethane wheels eliminate air pressure problems
- Attached wheels for easy transport
- Best suited to throw dimple balls
- Weight: 95 lbs.

<b>BULLELITEBB</b>	Baseball Model	<b>\$3,299<sup>99</sup></b> EA ★
<b>BULLELITESB</b>	Softball Version	<b>\$3,299<sup>99</sup></b> EA ★
<b>ZPMLEGSB</b>	BB to SB conversion kit - Includes legs & chute	<b>\$299<sup>99</sup></b> SET ★
<b>ZPMLEGBB</b>	SB to BB conversion kit - Includes legs & chute	<b>\$299<sup>99</sup></b> SET ★



PROMOUNDS  
MAJOR LEAGUE  
GAME MOUND

### MAJOR LEAGUE GAME MOUNDS

- Made of high density foam & protected with Rubber Armor Technology.
- Converts your softball field into a baseball field
- Official Little League height specifications
- Great for indoor and outdoor use
- Lightweight, durable, portable
- Length allows pitching from the rubber and land on mound
- Please specify either green or red clay turf

<b>MP3003</b>	6"H x 60"W x 99"L	<b>\$1,699<sup>99</sup></b> EA
---------------	-------------------	--------------------------------



### FOUR PIECE GAME MOUND

- Meets all NCAA & MLB requirements
- Full regulation 18" fiberglass pitching mound
- 6 year warranty on fiberglass shell

<b>1396130</b>	18" Regulation	<b>\$16,439<sup>99</sup></b> EA	<b>SAH</b>
----------------	----------------	---------------------------------	------------

APPROVED FOR TOURNAMENT & GAME USE BY  



### PORTABLE GAME MOUND

- Reinforced fiberglass and covered with AstroTurf
- 6 year warranty on fiberglass base
- Meets all specifications in mound slopes, diameter and table size

<b>1450720</b>	10"H x 10'W x 12'6"L	<b>\$6,299<sup>99</sup></b> EA	<b>SAH</b>
----------------	----------------------	--------------------------------	------------

ALL MOUNDS AVAILABLE IN GREEN OR CLAY.



### PORTABLE GAME MOUND

- Reinforced fiberglass and covered with AstroTurf®
- Rubber landing pad included for added shell protection and performance
- 6 year warranty on fiberglass shell

<b>BBPORTRE</b>	Senior - 10"H x 10'W x 12'6"L	<b>\$5,399<sup>99</sup></b> EA	<b>SAH</b>
-----------------	-------------------------------	--------------------------------	------------



### TALLY COUNTER

- Hand held model
- Counts up to 9999

<b>MSHTALLY</b>	<b>\$18<sup>99</sup></b> EA ★
-----------------	-------------------------------



### RO SIN BAG

- High quality rosin in resealable polybag for long-lasting use.



<b>5A162628</b>	<b>\$19<sup>99</sup></b> EA
-----------------	-----------------------------

# MOUNDS



Green Turf  
Red Clay Turf



Includes free measuring tape!



## TWO PIECE PRACTICE MOUND

- 2-piece mound w/turf made with high density foam and protected with Rubber Armor Technology
- Skid proof, non-slip bottom - won't damage gym floors
- Used by NCAA Division 1 programs

MP2031 Size - 10"H x 4"W x 9"L \$1,599<sup>99</sup> EA

## COACH'S CHOICE

### PITCHER'S PLATFORM

- Protects field during batting practice
- Rugged aluminum frame
- Attached tires for easy portability
- Non-marking pads included for indoor use
- Mound height adjusts from 10" to 6"
- No flat tires

BS PROPLAT 7'L x 3'W x 10' 6" H \$1,499<sup>99</sup> EA



Includes free measuring tape!



## PRACTICE MOUND WITH TURF

- Heavy duty polystyrene that is completely encased in a thick rubber coating for durability
- Rubber coating is skid resistant and will not damage gym floors
- Spike proof turf top will accommodate all cleats including metal

1237146 Size - 10"H x 5"W x 9"L \$1,749<sup>99</sup> EA   
1237153 Size - 10"H x 4"W x 9"L \$1,649<sup>99</sup> EA



# SOFTBALL PITCHERS MATS



## JENNIE FINCH PITCHER'S LANE PRO

- Regulation pitching rubber attached and made from spike-resistant artificial turf with a no slip backing.
- Helps pitchers comply with NCAA regulations (Rule 2.19) that restricts pitchers from pitching outside the 24' pitching rubber.
- Comes with a free carrying case.

1291360 Size - 3'W x 10'L \$379<sup>99</sup> EA



## PROMOUNDS JENNIE FINCH PITCHING MAT WITH POWERLINE

- Pitching mats made from spike-resistant/turf
- 2" wide inlaid white line for more precise training
- Regulation pitching rubber attached
- Comes with a convenient carrying case
- Non-skid bottom for gym floors

1266016 3'W x 10' L \$359<sup>99</sup> EA





**OFFICIAL LEAGUE**

- Leather cover
- Cork and rubber core
- Yarn windings
- Flat seams

**BSOLBFS**

Flat Seam

**\$53.99** DZN ★



**D1 PRO**

- Full grain leather cover
- Cushioned cork center
- Grey wool windings
- Low seam (flat seam)

**1385517**

Flat Seam

**\$152.99** DZN



**FSR1 NCAA**

- Official ball of the NCAA
- Full grain leather cover
- Cushioned cork center
- Wool windings
- Flat seam

**1385512**

Flat Seam

**\$149.99** DZN



**FSR100 NAIA**

- Official ball of the NAIA
- Full grain leather cover
- Cushioned cork center
- Wool windings
- Flat seam

**1385513**

Flat Seam

**\$147.99** DZN



**A1030**

- Grade C/D full grain leather
- Red cushioned cork
- Gray wool windings
- Flat seam

**1385406**

Flat Seam

**\$72.99** DZN

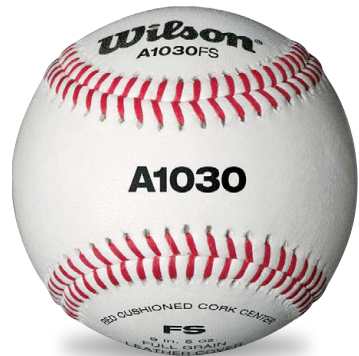

**A1010 PRO**

- Grade A full grain leather
- Cushioned cork
- Premium gray wool windings
- Flat seam

**1385405**

Flat Seam

**\$109.99** DZN

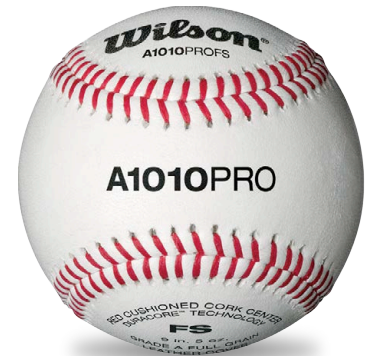





**Wilson**  
**A1010 BLEM**

- Minor imperfections
- Full grain leather cover
- Cushioned cork center
- Great practice ball

**WLWTA1010**

\$59<sup>99</sup> DZN

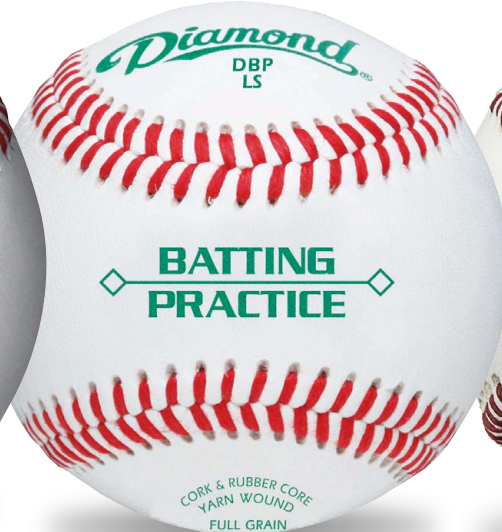

**Diamond**  
**DBP-FS**

- Full grain leather cover
- Cork and rubber core
- Yarn windings
- Low seam (flat seam)

**1385518**

Flat Seam

\$102<sup>99</sup> DZN

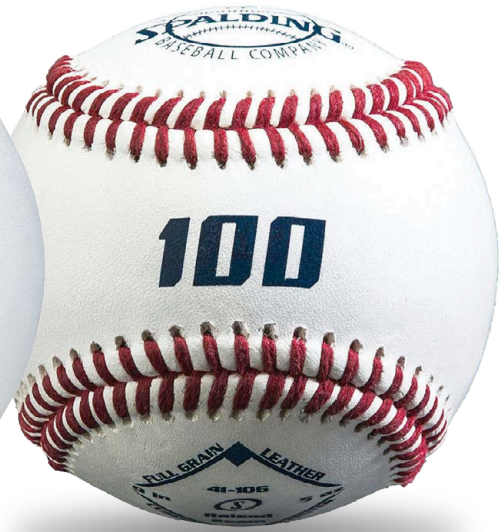

**41106 PRACTICE BASEBALL**

- Full grain leather cover
- Cushioned cork center
- Improved grip for accuracy

**WC41106HS**

\$84<sup>99</sup> DZN



**Rawlings**

**FSOLBX - PRACTICE**

- Practice Ball
- Leather cover
- Flat seams

**1385515**

Flat Seam

\$102<sup>99</sup> DZN



**Rawlings**

**ULTIMATE PRACTICE - RS**

- Molded polyurethane cover
- Raised seams for improved grip
- HS batting practice baseball

**RWR100-UP1**

Raised Seam

\$149<sup>99</sup> DZN



**Rawlings**

**ULTIMATE PRACTICE - FS**

- Molded polyurethane cover
- Flat seam for improved grip
- Collegiate batting practice baseball

**RWFSR100-UP**

Flat Seam

\$217<sup>99</sup> DZN



**MARK 1**

**OFFICIAL LEAGUE**

- Leather cover
- Cork and rubber core
- Yarn windings
- Raised seams

**1236002**

\$49.99 DZN ★

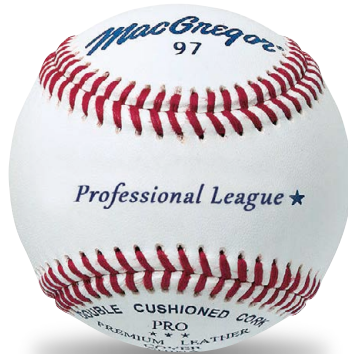

**MacGregor**  
**#97 PROFESSIONAL LEAGUE**

- Cushioned cork center
- Grey english wool windings
- A grade leather cover
- Raised seams

**MCB97PRO**

\$84.99 DZN ★



**MacGregor**  
**#97 MAJOR LEAGUE**

- Cushioned cork center
- Gray/white/gray yarn windings
- A grade leather cover
- Raised seams

**MCB97MLH**  
**MCB97MLX**

NOCSAE/NFHS Stamped  
w/o NFHS Logo

\$84.99 DZN ★  
\$84.99 DZN ★

**NFHS**  
APPROVED



**MacGregor**  
**#79 PRACTICE**

- Cork and rubber core
- Raised seams

**MCB79PXX**  
**MCB79PYX**

Leather \$54.99 DZN ★  
Synthetic \$38.99 DZN ★



**MacGregor**  
**#87SP OFFICIAL LEAGUE**

- Cork and rubber center
- Split leather cover
- Raised seams

**MCB87SPX**

\$52.99 DZN ★



**MacGregor**  
**#87OL OFFICIAL LEAGUE**

- Cushioned cork center
- Select wool windings
- Leather cover
- Raised seams

**MCB87OLX**

\$66.99 DZN ★



**Wilson**  
**A1010 H.S. SST**

- Red cushion cork center
- Premium wool windings
- NOCSAE/NFHS Stamped

**5A1010BHS1SST** \$104.99 DZN



**Wilson**  
**A1030B HS**

- Cushioned cork center
- Grey wool windings
- Grade C leather cover
- Raised seams

**5A1030B** \$72.99 DZN



**SPALDING**  
**PRO 100 NFHS**

- Leather cover
- Cushioned cork center
- Raised seams
- NOCSAE/NFHS Stamped

**WC41100HS** \$122.99 DZN



**Wilson**  
**A1010 PRO - NFHS**

- Grade A full grain leather
- Premium gray wool windings
- Raised seams
- Red cushioned cork center
- NOCSAE/NFHS Stamped

**CCA1010BPRO** \$129.99 DZN

**NFHS**  
APPROVED

**NFHS**  
APPROVED

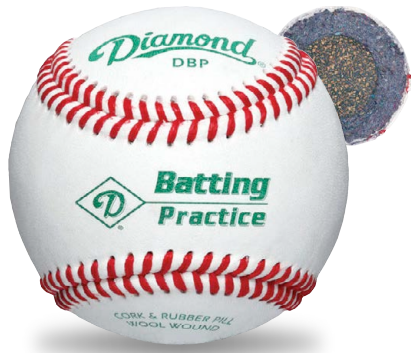

**Diamond**

**DBP**

- Cork and rubber pill
- A-Grade gray wool winding
- Premium leather cover
- Diamond Seam™

**1159042** \$88<sup>99</sup> DZN

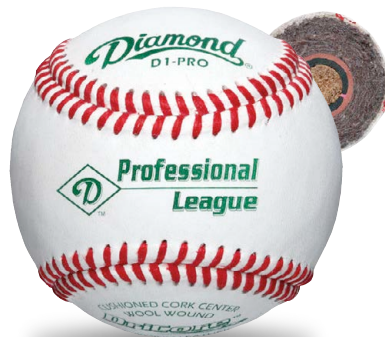

**Diamond**

**D1-PRO**

- Cushioned cork center
- A-1 grade wool winding
- Premium leather cover
- Diamond Seam™

**1187359** \$144<sup>99</sup> DZN



**Diamond**

**DOL-1 HS**

- Cork & rubber core
- Yarn windings
- Full-grain leather cover
- NOCSAE/NFHS Stamped

**1453927** \$97<sup>99</sup> DZN



**Diamond**

**D1 PRO HS**

- Cushioned cork center
- Finest grade grey wool windings
- Ultra-premium full-grain leather cover
- NOCSAE/NFHS Stamped

**1453923** \$132<sup>99</sup> DZN

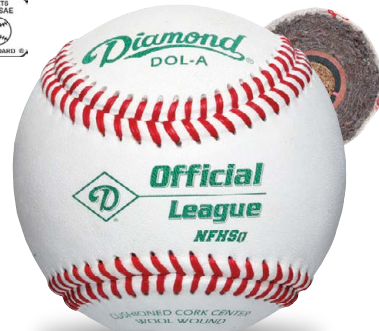

**Diamond**

**DOL-A HS**

- Cushioned cork center
- Yarn wound
- Full-grain leather cover
- NOCSAE/NFHS Stamped

**1453926** \$112<sup>99</sup> DZN



**Diamond**

**D1 HS**

- Cushioned cork center
- Grey wool windings
- Premium full-grain leather cover
- NOCSAE/NFHS Stamped

**1453924** \$124<sup>99</sup> DZN



**Baden**

**3B-NFHS**

- Premium Leather cover
- Performance seams
- Ballistic windings
- NOCSAE/NFHS Stamped

**1362015** \$117<sup>99</sup> DZN

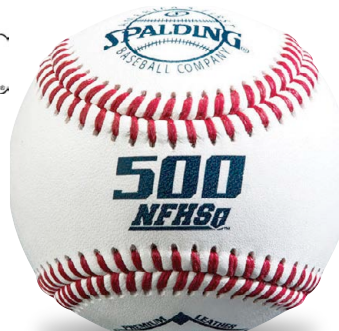

**SPALDING**

**PRO 500**

- Leather cover
- Gray wool windings
- Cushioned cork center
- NOCSAE/NFHS Stamped

**WC41101HS** \$114<sup>99</sup> DZN



**Rawlings**

**R100 H3**

- Full grain leather cover
- Raised seam for improved grip
- Cushioned cork center
- Wool windings
- NOCSAE/NFHS Stamped

**RWR100H3** \$126<sup>99</sup> DZN



**CUSTOM  
BASEBALL  
PROGRAM**  
CALL FOR MORE  
INFORMATION



*Little League*



**MacGregor**

**#76C**

- Cushioned cork center
- Select wool windings
- C Grade Leather cover
- Raised seams / RS-T stamped

**MCB76CXX** C Grade Cover \$63<sup>99</sup> DZN ★



**Rawlings**

**RLLB**

- Full grain leather cover
- Raised seams
- RS-T stamped

**1055740** Cushioned Cork \$104<sup>99</sup> DZN

**1055757** Cork & Rubber \$72<sup>99</sup> DZN



**MacGregor**

**#76C1**

- Cork and rubber center
- Select wool windings
- Raised seams

**MCB76C1X** Leather Cover \$62<sup>99</sup> DZN ★



**Diamond**

**DLL-1**

- Little League competition grade baseball
- Premium leather cover
- Raised seams

**1159103** Cork & Rubber \$84<sup>99</sup> DZN

**1159097** DLL Cushioned Cork \$104<sup>99</sup> DZN



**SPALDING**

**LITTLE LEAGUE**

- Leather cover
- Cushioned cork center
- Gray wool windings

**WC41102LL** RS-T Stamp \$82<sup>99</sup> DZN



**Wilson**

**A1074BSST**

- Red cushion cork center
- Grey wool windings
- Raised seams

**5A1074BLL1** C Grade Cover \$69<sup>99</sup> DZN



**Diamond**

**DSLL-1 SENIOR LEAGUE**

- Cork and rubber pill center
- Select wool blend winding
- Premium leather cover
- Diamond Seam

**1159127** \$88<sup>99</sup> DZN



**MacGregor**

**#73C SENIOR LEAGUE**

- Cushioned cork center
- Select wool windings
- Leather cover
- Raised seams

**MCB73CXX** \$66<sup>99</sup> DZN ★



**Rawlings**

**RSLL**

- Cushioned cork center
- Full grain leather cover
- Raised seams
- RS-T stamped

**1055764** RSLL \$98<sup>99</sup> DZN  
**1195637** RSLL-1 \$88<sup>99</sup> DZN

**PRACTICE BALL**

**TEE BALL**



**Rawlings**

**ULTIMATE PRACTICE BALL**

- Molded polyurethane cover
- Raised seams for improved grip
- Designed for youth practice

**RWR100-UPY** \$67<sup>99</sup> EA

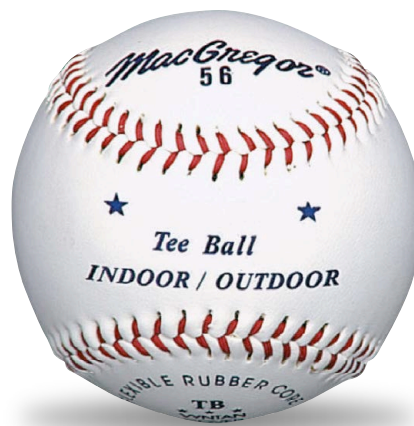

**MacGregor**

**#56 OFFICIAL TEE BALL**

- "Vyntan" synthetic leather cover
- Low bounce rubber core
- Double-stitched seams
- Ideal for tee ball & indoor or outdoor training

**MCB56TBX** \$64<sup>99</sup> DZN ★

**CUSTOM  
BASEBALL  
PROGRAM**  
CALL FOR MORE  
INFORMATION



## BABE RUTH

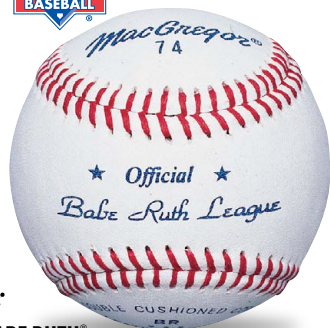

**MacGregor**

**#74 OFFICIAL BABE RUTH®**

- Cushioned cork center
- Select wool windings
- Leather cover
- Raised seams

**MCB74CXX** \$62.99 DZN ★



**Rawlings**

**RBRO(1) BABE RUTH®**

- Cushioned cork center
- Leather cover
- Raised seams

**1055771** RBRO \$102.99 DZN  
**1055788** RBRO1 \$79.99 DZN



**Diamond**

**DBR-1 BABE RUTH**

- Cork and rubber pill
- Select wool blend winding
- Premium leather cover
- Competition grade baseball

**1159080** \$96.99 DZN



## CAL RIPKEN



**MacGregor**

**#74 CAL RIPKEN®**

- Cork and rubber center
- Select wool windings
- Leather cover
- Raised seams

**MCB74CAL** \$59.99 DZN ★



**Rawlings**

**RCAL CAL RIPKEN TOURNAMENT**

- Cushioned cork center
- 15% wool windings
- Full-grain leather cover
- Raised seams

**RWRCAL** \$97.99 EA



**Rawlings**

**RCAL1 CAL RIPKEN®**

- Cork and rubber center
- Full grain leather cover
- Raised seams

**1055795** \$77.99 DZN



## USSSA

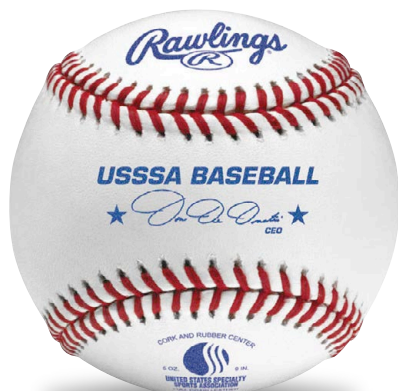

**Rawlings**

**ROLB1 - USSSA**

- Cork and rubber center
- Full grain leather cover
- Raised seams
- USSSA approved

**1055801** ROLB1 \$72.99 DZN  
**1055818** ROLB1X \$65.99 DZN



**Wilson**

**A1030 USSSA**

- Cushioned cork center
- Gray wool yarn
- Grade C leather cover
- Raised seam

**1195279** \$82.99 DZN



## PONY

**CUSTOM  
BASEBALL  
PROGRAM**  
CALL FOR MORE  
INFORMATION

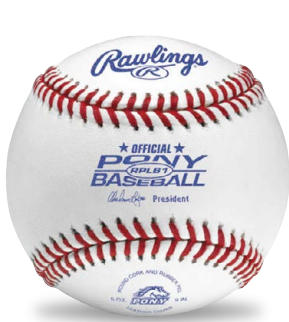

### Rawlings RPLB1 PONY LEAGUE

- Cork and rubber center
- Full grain leather cover
- Raised seams

1420274 \$79<sup>99</sup> DZN

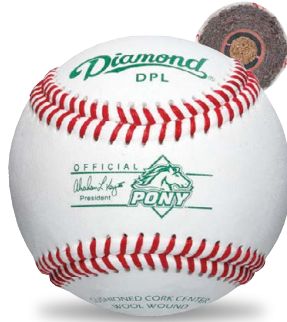

### Diamond DPL PONY LEAGUE

- Cushioned cork center
- A-Grade gray wool winding
- Premium leather cover
- Tournament grade

1159059 \$94<sup>99</sup> DZN



### MacGregor #75 OFFICIAL PONY®

- Cushioned cork center
- Select wool windings
- Leather cover
- Raised seams

MCB75CXX \$72<sup>99</sup> DZN ★



### MacGregor #75CY YOUTH PONY®

- Cork and rubber center
- Select wool windings
- Leather cover
- Raised seams

MCB75CYX \$59<sup>99</sup> DZN ★



## DIXIE

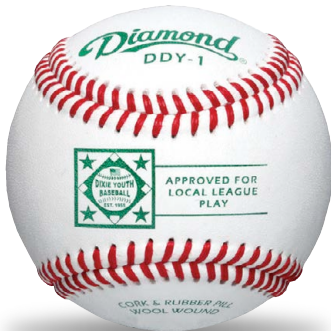

### Diamond DDY-1 DIXIE YOUTH

- Cork and rubber pill
- Select wool blend winding
- Premium leather cover
- Diamond Seam™

1159141 \$92<sup>99</sup> DZN

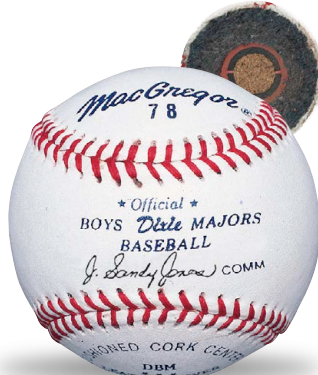

### MacGregor #78 DIXIE® BOYS & MAJORS

- Cushioned cork center
- Select wool windings
- Leather cover
- Raised seams

MCB78CXX \$64<sup>99</sup> DZN ★



### MacGregor #72 DIXIE® YOUTH

- Cork and rubber center
- Select wool windings
- Leather cover
- Raised seams

MCB72CXX \$66<sup>99</sup> DZN ★



## DIZZY



### Rawlings RZDY1 DIZZY DEAN

- Cork and rubber center
- Full grain leather cover
- Raised seams

1419932 \$77<sup>99</sup> DZN

## SAFETY

### MacGregor SAFE/SOFT BASEBALL

- 3 LEVELS OF SAFETY FOR ALL AGES
- Meets NOCSAE standard
- Leather cover with patented Tri-Flex safety core
- Raised seams

MCB5SV01	Level 1 Ages 5 - 7	\$84 <sup>99</sup> DZN ★
MCB5SV05	Level 5 Ages 8-12	\$84 <sup>99</sup> DZN ★
MCB5SV10	Level 10 Ages 12+	\$84 <sup>99</sup> DZN ★



**BEST  
SELLER**



**MacGregor  
LITTLE LEAGUE®**

- League approved / stamped
- COR .47/375 lb max comp.
- Poly graphite center
- Synthetic leather cover

<b>MCSB11LLY</b>	11"	\$112 <sup>99</sup> DZN ★
<b>MCSB12LLY</b>	12"	\$112 <sup>99</sup> DZN ★

**MARK 1**

**NFHS**

**NFHS®  
APPROVED**

- 12" NFHS approved
- COR .47/375 max comp.
- Leather cover
- Raised stitch
- Poly-core

<b>BSOSB</b>	12"	\$94 <sup>99</sup> DZN ★
--------------	-----	--------------------------



**PRACTICE**

- Slowpitch or fastpitch
- COR, compression, cover, center may vary

<b>5PSBY11</b>	11"	\$84 <sup>99</sup> DZN ★
<b>5PSBY12</b>	12"	\$84 <sup>99</sup> DZN ★

**BATTING PRACTICE**

**EVIL SPORTS**



**BATTING PRACTICE**

- .44 COR
- 400 Comp
- Leather cover
- Red stitches

<b>1394802</b>	12"	\$86 <sup>99</sup> DZN
----------------	-----	------------------------



**MacGregor  
ASA®**

- ASA® approved
- Cor. .47 / 375 lb max comp
- Poly graphite center
- Leather cover
- Red stitch

<b>MCSB11YL</b>	11"	\$112 <sup>99</sup> DZN ★
<b>MCSB12YL</b>	12"	\$112 <sup>99</sup> DZN ★



**MacGregor  
NFHS - FP**

**NFHS - FP**

**NFHS®  
APPROVED**

- .47 COR
- 375 Comp
- Poly graphite center
- Leather cover
- Red stitch

<b>MCSB12YH</b>	12"	\$112 <sup>99</sup> DZN ★
-----------------	-----	---------------------------



**TRUMP**

**NFHS/ASA - FP**

**NFHS®  
APPROVED**

- .47 COR
- 375 Comp
- Leather cover
- Red Stitch

<b>1394818</b>	12"	\$104 <sup>99</sup> DZN
<b>1394817</b>	11"	\$104 <sup>99</sup> DZN



**BATTING PRACTICE**

- .52 COR
- 300 Comp
- Leather cover
- Black stitch

<b>1394803</b>	12"	\$86 <sup>99</sup> DZN
----------------	-----	------------------------



**MacGregor  
PONY®**

- Pony approved
- COR .47/375 lb max comp.
- Poly graphite center
- Leather cover

<b>MCSB11PNY</b>	11"	\$107 <sup>99</sup> DZN ★
<b>MCSB12PNY</b>	12"	\$107 <sup>99</sup> DZN ★



**Wilson**

**A9011 - NFHS FP**

**NFHS®  
APPROVED**

- .47 COR
- 375 lb Max Comp.
- Leather Cover
- Red SST Stitching

<b>5A9011BSST</b>	12"	\$124 <sup>99</sup> DZN
-------------------	-----	-------------------------



**Baden**

**PERFECTION - NFHS FP**

**NFHS®  
APPROVED**

- .47 COR
- 375 lb max comp.
- Leather cover
- Poly core

<b>1323429</b>	12"	\$149 <sup>99</sup> DZN
----------------	-----	-------------------------



**MacGregor**

**SAFE/SOFT TRAINING**

- Perfect for drills
- Leather cover
- Tri-Flex safety core

<b>MCSB11SS</b>	11"	\$112 <sup>99</sup> DZN ★
<b>MCSB12SS</b>	12"	\$112 <sup>99</sup> DZN ★



# DUDLEY SOFTBALLS



**4U-542Y-THUNDER SY CLASSIC W-SP**

- USSSA approved
- .44 COR
- 400 Comp.
- Classic W stamped
- Synthetic cover

**1300291** 11" \$72<sup>99</sup> DZN



**4A-068Y-THUNDER ZN HYCON-SP**

- ASA approved
- .52 COR
- 375 Comp
- Composite cover
- Red Stitch

**1375626** 12" \$87<sup>99</sup> DZN



**4U541Y-THUNDER SY USSSA-SP**

- USSSA approved
- .40 COR
- 325 Comp.
- Classic M stamped
- Synthetic cover

**1265996** 12" \$82<sup>99</sup> DZN



**NFHS APPROVED**

**43-147-THUNDER HEAT NFHS-FP**

- NFHS approved
- .47 COR
- 375 Comp.
- Poly graphite center
- Leather cover

**BBDNHFSY** 12" \$109<sup>99</sup> DZN



**4A-069Y-ASA THUNDER SY HYCON-SP**

- ASA Approved
- .52 COR
- 300 Comp
- Synthetic cover
- Red stitch

**1375627** 12" \$92<sup>99</sup> DZN



**4E-824Y THUNDER SY-FP**

- NSA Approved
- .44 COR
- 375 Comp
- Synthetic cover
- ICON Stamp

**1453914** 12" \$74<sup>99</sup> DZN  
**1453915** 11" \$74<sup>99</sup> DZN



**43-184Y-THUNDER ADVANCE MLT-SP**

- Non-association ball
- .44 COR
- 375 Comp.
- Advance MLT series tech.
- Composite cover
- Blue stitch

**1300284** 12" \$92<sup>99</sup> DZN



**4A-065Y-ASA THUNDER HEAT HYCON-SP**

- ASA approved
- .52 COR
- 300 Comp
- Leather cover
- Red stitch

**1375625** 12" \$99<sup>99</sup> DZN

# WORTH SOFTBALLS



**SUPER GOLD DOT CLASSIC SLOW PITCH**

- USSSA approved
- .40 COR
- 325 Comp.
- Pro Tac cover
- Poly-core with C-Lok technology

**1265774** 12" \$97<sup>99</sup> DZN



**BLUE DOT SLOW PITCH**

- Not ASA approved
- .47 COR
- 525 Comp.
- Pro Tac cover
- Poly graphite center

**1193930** 12" \$96<sup>99</sup> DZN



**HOT DOT SLOW PITCH**

- ASA Approved
- .52 COR
- 300 Comp
- Red stitch
- C-LOK technology

**1385211** 12" \$99<sup>99</sup> DZN

# Rawlings SOFTBALLS



**RED DOT FAST PITCH**

- ASA/NFHS Approved
- .47 COR
- 375 Comp
- Leather cover
- 88 red stitch
- Poly X core

**RWPX2RYLAH** 12" \$124<sup>99</sup> DZN



**DREAM SEAM FAST PITCH**

- ASA/NFHS approved
- .47 COR
- 375 Comp
- High-density cork core
- Optic yellow cover
- 88 red stitch

**RWC12RYLAH** 12" \$114<sup>99</sup> DZN  
**RWC11RYLA** 11" \$114<sup>99</sup> DZN



**OFFICIAL NCAA CHAMPIONSHIP FAST PITCH**

- Official NCAA championship ball
- .47 COR
- 400 Comp
- Polycore center
- Pro leather cover
- Raised seam, red stitch

**RWNC12L** 12" \$159<sup>99</sup> DZN

**CUSTOM  
BASEBALL  
PROGRAM**  
CALL FOR MORE  
INFORMATION

# ASA



**EVIL SPORTS**

**ASA**

- .52 COR
- 300 Comp
- Leather cover
- Red stitch

**1394793** 12" **\$112<sup>99</sup>** DZN



**THE ROCK.  
ROCK - ASA**

- .52 COR
- 300 Comp
- Composite cover
- Red Stitch

**1394808** 12" **\$104<sup>99</sup>** DZN



**EVIL SPORTS**

**ASA**

- .44 COR
- 375 Comp
- Leather cover
- Red stitch

**1394792** 12" **\$99<sup>99</sup>** DZN



**THE ROCK.  
ASA**

- .44 COR
- 375 Comp
- Composite cover
- Red stitch

**1394807** 12" **\$104<sup>99</sup>** DZN  
**1394806** 11" **\$104<sup>99</sup>** DZN



**MacGregor**

**ASA**

- ASA approved
- COR 52/300 max. comp
- Poly graphite core
- Red stitching

**1377375** 12" - Synthetic Cover **\$78<sup>99</sup>** DZN ★  
**1377376** 12" - Composite Cover **\$87<sup>99</sup>** DZN ★  
**1377377** 12" - Leather Cover **\$107<sup>99</sup>** DZN ★



**MacGregor**

**ASA**

- ASA<sup>®</sup> approved
- COR .44 / 375 lb max comp.
- Yellow leather cover
- Red stitching
- Compressed cork core

**1280517** 11" **\$86<sup>99</sup>** DZN ★



**TRUMP**

**ASA**

- .44 COR
- 375 Comp
- Synthetic leather cover
- Red stitch

**1394814** 12" **\$82<sup>99</sup>** DZN  
**1394813** 11" **\$82<sup>99</sup>** DZN

# USSSA



**EVIL SPORTS**

**USSSA**

- .40 COR
- 325 Comp
- Leather cover
- Blue stitch

**1394795** 12" **\$102<sup>99</sup>** DZN



**TRUMP**

**USSSA**

- .40 COR
- 325 Comp
- Synthetic cover
- Blue Stitch

**1394816** 12" **\$87<sup>99</sup>** DZN



**EVIL SPORTS**

**USSSA**

- .52 COR
- 275 Comp
- Leather cover
- Blue stitch

**1394796** 12" **\$82<sup>99</sup>** DZN  
**LD806AKEZCLASWYO** 11" **\$82<sup>99</sup>** DZN



**THE ROCK.  
USSSA**

- .52 COR
- 325 Comp
- Composite cover
- Blue Stitch

**1394810** 12" **\$104<sup>99</sup>** DZN



**THE ROCK.  
USSSA**

- .44 Cor
- 400 Comp
- Composite cover
- Blue Stitch

**1394809** 11" **\$104<sup>99</sup>** DZN

**EVIL SPORTS**

**EVIL NSA 12"  
44/400-LEATHER**

- .44 COR
- 400 comp
- Leather cover

**1453231** 12" \$82<sup>99</sup> DZN



**THE ROCK.  
XROCK NSA 12"  
44/400-COMPOSITE**

- .44 COR
- 400 Comp
- Composite cover

**1453235** 12" \$84<sup>99</sup> DZN ★



**THE ROCK.  
NSA**

- .52 COR
- 275 Comp
- Black Stitch

**1394812** 12" \$94<sup>99</sup> DZN



SSUSA

**TRUMP**

**SSUSA**

- .44COR
- 375 Comp
- Micro-cell cover

**1453886** 12" \$69<sup>99</sup> DZN ★



ISA

**THE ROCK.  
ISA**

- Composite cover
- .44 COR
- 400 Comp

**1453228** 12" \$69<sup>99</sup> DZN ★



NON SANCTIONED

**EVIL SPORTS**

**44 MAX**

- .44 COR
- 525 Comp
- Blue stitch

**1394797** 12" \$84<sup>99</sup> DZN



**EVIL SPORTS**

**ULTIMATE EVIL**

- .53 COR
- 500 Comp
- Red/Orange stitch

**1394800** 12" \$82<sup>99</sup> DZN



## SPECIALTY BALLS

16"

9"

12"



### UNBELIEVA-BALL

- State of the art, sting free and safe!
- Made of a high density foam core surrounded by nylon windings and a heavy duty cloth cover.
- Raised seams for a more realistic feel.
- Machine washable and long lasting.
- Perfect training aid for both indoor and outdoor play.

<b>1300932</b>	9" Baseball - White	<b>\$92<sup>99</sup></b> DZN ★
<b>1300949</b>	11" Softball - Yellow	<b>\$109<sup>99</sup></b> DZN ★
<b>1300956</b>	12" Softball - Yellow	<b>\$112<sup>99</sup></b> DZN ★
<b>1300963</b>	12" Softball - White	<b>\$112<sup>99</sup></b> DZN ★
<b>1300970</b>	16" Softball - White	<b>\$32<sup>99</sup></b> EA ★

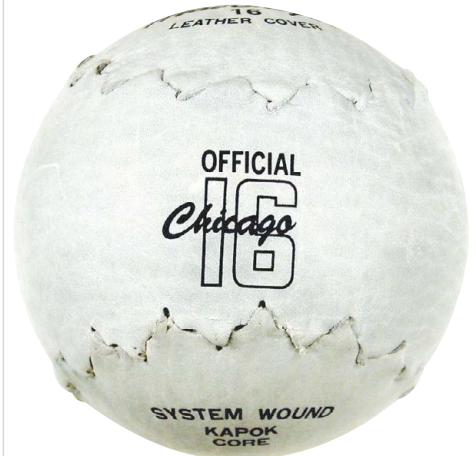

### SOFTOUCH™ INCREDI-BALL®

- Features a unique safety core for limited flight and reduced injuries
- Polyurethane core with durable synthetic leather cover
- Perfect for younger game play or indoor/outdoor training for all ages

<b>BBST9W</b>	9" Baseball - White	<b>\$86<sup>99</sup></b> DZN
<b>BBST11Y</b>	11" Softball - Neon	<b>\$89<sup>99</sup></b> DZN
<b>BBST12Y</b>	12" Softball - Neon	<b>\$89<sup>99</sup></b> DZN



### SOFTSTITCH™ INCREDI-BALL®

- INCREDI-BALL® sting free, safe, softwound balls with a lockstitch, double-knit cover.
- Washable, and will last as long as a regular ball.
- Carries 75% of distance when hit.
- A great training aid for indoors or outdoors.

<b>BBSS9W</b>	9" Baseball - White	<b>\$83<sup>99</sup></b> DZN
<b>BBSS11Y</b>	11" Softball - Yellow	<b>\$89<sup>99</sup></b> DZN
<b>BBSS12Y</b>	12" Softball - Yellow	<b>\$79<sup>99</sup></b> DZN



### CHICAGO 16™

- Leather
- COR .47
- Kapok center

<b>MCSB16CH</b>	16"	<b>\$32<sup>99</sup></b> EA ★
-----------------	-----	-------------------------------

## PITCHING MACHINE BALLS



### SUPER SOFT TRAINING BALL

- Compare to SFT® Supersoft™ balls
- Perfect indoor training ball

<b>1155020</b>	9" Baseball	<b>\$62<sup>99</sup></b> DZN ★
<b>1155037</b>	12" Softball	<b>\$64<sup>99</sup></b> DZN ★



### MacGregor® DIMPLED MACHINE BALLS

- Soft, durable yellow polyurethane
- Designed safe for aluminum bats



<b>MCBDBYEL</b>	9" Baseball	<b>\$52<sup>99</sup></b> DZN ★
<b>BBDSBALL</b>	12" Softball	<b>\$82<sup>99</sup></b> DZN ★

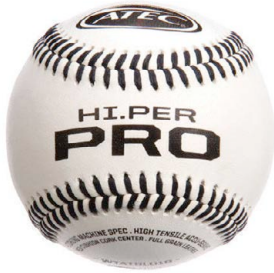

### HI.PER PRO LEATHER MACHINE BASEBALL

- Premium full grain leather balls with cushioned cork center
- High tensile strength accu-seams
- Regulation size and weight
- Aerodynamically optimized for pitching machine use

<b>K15837</b>		<b>\$89<sup>99</sup></b> DZN
---------------	--	------------------------------



### SEAMED PITCHING MACHINE BALLS

- Patented red seamed dimpled pitching machine ball
- Inset seams will not come in contact with machine wheels protecting red seams from wear
- Baseball appearance trains batter's eye for the real pitch

<b>1237269</b>	9" White Baseball	<b>\$71<sup>99</sup></b> DZN
<b>1237276</b>	12" Yellow Softball	<b>\$77<sup>99</sup></b> DZN



### LITE MACHINE BALLS WITH SEAMS

- Compare to ATEC SFT® balls
- Ideal training ball for all ages
- Designed safe for indoor/outdoor
- Will travel as far as a regulation ball
- Works in most pitching machines

<b>1155006</b>	9" Baseball	<b>\$72<sup>99</sup></b> DZN ★
----------------	-------------	--------------------------------

## TRAINING BALLS



### PLASTIC 'CURVE' BALL

Unique hole design allows for easy curveball action.

<b>3192XXXX</b>	12" Softball	<b>\$2<sup>49</sup></b> EA
-----------------	--------------	----------------------------



### PLASTIC TRAINING BALLS

- Designed for true slow and limited flight

<b>1033601</b>	9" Baseball	<b>\$22<sup>99</sup></b> SET OF 6 ★
<b>1033618</b>	12" Softball	<b>\$24<sup>99</sup></b> SET OF 6 ★



### 9" WIFFLE™ BALL BASEBALL

Designed for true slow and limited flight. 9" baseball size.

<b>1141245</b>	Wiffle® 9" Baseball	<b>\$3<sup>99</sup></b> EA
----------------	---------------------	----------------------------



### TCB SUPER WEIGHTED BALLS

- Approx. 5.2"D - Softball size
- Weighs 900 grams
- Use for soft toss or tee work
- Strength development for the core and upper body

<b>K10707</b>	TCB Atomic Balls (set of 6)	<b>\$84<sup>99</sup></b> SET
---------------	-----------------------------	------------------------------



### TCB TRAINING BALLS

- Approx. 3.2"D - Baseball Size
- Used for soft toss, front toss and tee work
- Helps players "drive-thru" the hitting zone
- Ball weighs 425 grams

<b>K10704</b>	Weighted	<b>\$109<sup>99</sup></b> DZN
---------------	----------	-------------------------------



### TCB TRAINING BALLS

- Perfect for front toss drills
- Great for hand eye coordination
- Hits better, throws better than ordinary plastic balls
- Designed to last

<b>K10705</b>	With Holes - Golf Ball Size	<b>\$47<sup>99</sup></b> DZN
<b>K10706</b>	With Holes - Standard 3.2"	<b>\$62<sup>99</sup></b> DZN



### 1. BUCKET W/ BASEBALLS

- Bucket with 3 dz. MacGregor 79P practice baseballs (MCB79PXX)
- 6 gallon plastic bucket w/ cushioned lid
- Holds up to 5 dz. baseballs or 2 dz. softballs

**1378434** Bucket w/ balls \$197<sup>99</sup> EA ★  
**1378437** Bucket Only \$44<sup>99</sup> EA ★

### 2. BUCKET W/ MARK 1 BALLS

- Bucket with 3 dz Mark 1 Official League Baseballs (BSOLB)
- Heavy duty 6 gallon plastic bucket with cushioned lid

**1378435** Bucket w/balls \$197<sup>99</sup> EA ★

### 3. BUCKET W/ SOFTBALLS

- 2 dz. practice softballs
- COR, compression, cover, center and brand of balls may vary.

**1378432** 11" \$169<sup>99</sup> EA ★  
**1378433** 12" \$169<sup>99</sup> EA ★



**BSN SPORTS FOLDING BALL CART**

- Holds approx 100 baseballs and 50 softballs
- Removable ball bag
- Stand designed for throwing batting practice
- Includes stand and legs

**1453880** 3' H \$92<sup>99</sup> EA



**EASTON COACH'S BUCKET COVER**

- Includes soft cushioned top, pockets for pens & line-up cards, a zipper pocket, and a mesh pocket for three game balls

**1237238** \$44<sup>99</sup> EA



**Diamond BALL BUCKET**

- Holds up to 5 dz baseballs
- Padded seat for comfort

**1404890** \$52<sup>99</sup> EA

**COACH'S CHOICE**



**BATTING PRACTICE BALL CART**

- Constructed of 1.5" O.D. powder coated steel
- Large capacity basket
- Oversized "no flat" tires
- 15" H x 15" W x 15" L

**1378683** Batting Practice Ball Cart \$389<sup>99</sup> EA ★  
**240210NF75** Replacement Wheel \$42<sup>99</sup> EA ★

BALLS NOT INCLUDED



**FOLDABLE BALL BIN**

- Waist high ball bin-ideal for soft toss or normal BP
- Foldable design allows for easy storage
- Holds over 100 baseballs or over 50 softballs

**1361841** \$279<sup>99</sup> EA ★

BALLS NOT INCLUDED



**ADJUSTABLE FIELD BALL CART**

- Heavy duty molded plastic hopper and large rear wheels for easy mobility
- Legs are height adjustable to raise/lower hopper height
- Holds 200 baseballs/100 softballs

**1237207** \$579<sup>99</sup> EA

**MacGregor**

**OFFICIAL BATTING TEE**

- Constructed of durable rubber components
- Features a solid metal base for added weight
- Adjustable hitting height from 20" to 36"
- Ideal for training players of all ages

<b>BBBATTEE9</b>	Black Tee	\$49.99 EA ★
<b>BBBATTUB9</b>	Black Replacement Inside Tube	\$16.99 EA ★

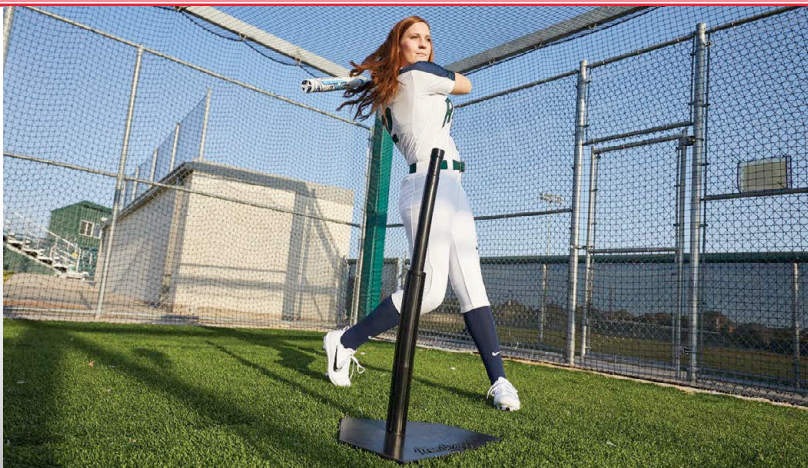

**THE PVTEE**

- Flexible pivot joint will have the tee back to the upright position before you are ready to put the next ball on
- Pivot joint allows impact of mis-hits to be realized in the joint and not the other tee components
- Flexible pivot joint takes impact away from batters hands and helps eliminates bat damage
- Unique magnet allows the tee to break down in one second
- Weighted base holds tee in place
- One year limited warranty

<b>1393592</b>	Standard Tee (27"-47")	\$159.99 EA
<b>1393597</b>	Low Stem Only (20"-26")	\$74.99 EA



**schutt**

**TRAVEL TEE**

- Lightweight, portable hitting tool for baseball or softball
- Breaks down for easy transport
- Telescoping tee allows you to adjust the height of the tee (29"-47")
- Includes a water-resistant carrying bag

<b>512830600</b>	Complete Travel Tee	\$82.99 EA
<b>1036978</b>	Replacement Top	\$14.99 EA



**VARSIY 5 POSITION BATTING TEE**

- Rugged hard-rubber construction
- Learn to control ball contact points for inside, outside and down the middle
- Allows over 20 different drill positions
- Adjustable from 20" - 39"

**10 Year Limited Warranty**

<b>1154818</b>	Complete Tee	\$102.99 EA ★
<b>1249897</b>	Replacement Top Tube	\$19.99 EA ★



**TUFFY® TEE**

- High strength polyurethane materials for unmatched durability
- Adjusts from 20" to 39"

**10 Year Limited Warranty**

<b>TUFFTEE1</b>	Single Tee	\$159.99 EA
-----------------	------------	-------------



**COACH'S CHOICE**



**TANNER TEES**

**TANNER TEE**

- Steel shaft has telescoping height adjustment
- Flexible ball rest for minimal resistance
- Breaks down easy for travel

<b>K11059</b>	Standard Tee (26"-43")	\$109.99 EA
<b>K11060</b>	Short Tee (20"-32")	\$102.99 EA



### XL DUFFLE EQUIPMENT BAG

- Breathable heavy duty cotton canvas
- Durable leather reinforced bottom
- Complete with shoulder strap and handle
- Black only



**1385404** 42"L x 20"W **\$57<sup>99</sup>** EA ★

### BALL BAG

- Coated nylon with heavy duty carrying straps and zippered top
- Durable plastic bottom provides long lasting protection against water damage and mildew
- Holds 48 baseballs or 24 softballs
- Black only



**1385399** **\$52<sup>99</sup>** EA ★



### TEAM EQUIPMENT BAG

- Heavy duty polyester equipment bag
- Rugged nylon zipper with wrap around handles
- Black only



**1377678** 33"L x 12"W x 15"H **\$29<sup>99</sup>** EA ★

### CATCHER'S EQUIPMENT BAG

- Heavy duty 600D polyester construction
- Professional strength carry straps
- Black only



**1385403** 35"L x 25"W x 19"H **\$69<sup>99</sup>** EA ★





**LARGE DUFFLE EQUIPMENT BAG**

- Durable 600 denier polyester bag with a thick web shoulder strap and handle
- Military style closure
- Black only

**1385397** 33"L x 18"W \$52.99 EA ★



**TEAM DUFFLE BAG**

- Zip close compartments on both ends
- Double handle carry straps
- Padded shoulder harness
- Denier nylon with breathable air vents
- Black only

**1377672** 27"L x 14"W x 12"H \$62.99 EA ★  
**1377675** 24"L x 12"W x 10"H \$47.99 EA ★



**BASEBALL/SOFTBALL EQUIPMENT TOTE**

- Strong 600 denier polyester
- Will hold 15 bats and has a zippered top for easy closing
- Separate zippered outside pocket for softballs or baseballs
- Double reinforced bottom with standard shoulder straps
- Black only

**1385398** 39"L x 12"W \$62.99 EA ★



**PLAYERS BAT PACK**

- Mid-sized backpack
- External side sleeves
- Interior room for a batting helmet and other gear
- 600D polyester construction
- Black only

**1385392** 14"L x 10"W x 19"H \$39.99 EA ★



**VARSITY BAT BAG**

- Tough vinyl material with a molded plastic round bottom
- The plastic bottom helps prevent tearing caused by dragging the bag
- Can hold up to 10 bats
- Black only

**1385396** 41"L x 10"W \$52.99 EA ★



**TEAM ROLLER BAG**

- 600 denier polyester shell
- Concealed pull handle
- Padded shoulder strap
- In-line wheel kit
- Oversized accessory pockets on both ends

Color Options: **Black, Royal, Scarlet.**

**1385400** 38"L x 16"W x 15"H \$144.99 EA ★

## CATCHER'S GEAR PACKS

All available in

BLACK

ROYAL

SCARLET



### JUNIOR CATCHER'S GEAR PACK

- Adjustable catcher's helmet
- MCB75 junior chest protector
- Junior double knee leg guards
- 4" throat protector

**\$159<sup>99</sup>**

**1186895** Ages 5-8 **\$159<sup>99</sup>** PACK ★



### YOUTH CATCHER'S GEAR PACK

- Adjustable catcher's helmet
- MCB74 youth chest protector
- Youth double knee leg guards
- 4" throat protector

**\$169<sup>99</sup>**

**1186833** Ages 9-12 **\$169<sup>99</sup>** PACK ★



### PREP CATCHER'S GEAR PACK

- Pro style varsity catcher's helmet
- MCB73 prep chest protector
- Prep double knee guards
- 4" throat protector

**\$259<sup>99</sup>**

**1186864** Ages 12-15 **\$259<sup>99</sup>** PACK ★



### ADULT CATCHER'S GEAR PACK

- Pro-style adult catcher's helmet
- MCB70 adult chest protector
- Varsity double knee leg guards
- 4" throat protector

**\$269<sup>99</sup>**

**1186802** Ages 15+ **\$269<sup>99</sup>** PACK ★

## CATCHER'S HELMETS



*Rawlings*

### HOCKEY STYLE CATCHER'S HELMET

- Meets revised NOCSAE standards
- Hockey style design - features rugged, durable ABS shell
- Dual foam liner with vents large air vents
- One size fits most

Color Options: **Black, Royal, Scarlet.**

**1383962** Fits Sizes 6 1/2 - 7 1/2 **\$114<sup>99</sup>** EA



*Rawlings*

### TWO-TONE CATCHER'S HELMET

- Meets revised NOCSAE standards
- Meets all NFHS requirements
- Sleek two-toned design and fit
- Clearview wire design for optimum visibility
- Multiple air vents
- Adjustable back plate

Color Options: **Black, Royal, Scarlet.**

**1383965** Varsity (7 1/8 - 7 3/4) **\$129<sup>99</sup>** EA  
**1383968** Youth (6 1/2 - 7) **\$104<sup>99</sup>** EA



# MacGregor CHEST PROTECTORS

All available in BLACK ROYAL SCARLET



**MCB75 YOUTH CHEST PROTECTOR**

1298345 Ages 5 to 8 \$52<sup>99</sup> EA ★



**MCB74 YOUTH CHEST PROTECTOR**

1298376 Ages 9 to 12 \$58<sup>99</sup> EA ★



**MCB73 PREP CHEST PROTECTOR**

1298406 Ages 13 to 15 \$67<sup>99</sup> EA ★



**MCB70 PRO CHEST PROTECTOR**

1298437 Ages 15+ \$72<sup>99</sup> EA ★



**MCB80/81 FEMALE CHEST PROTECTORS**

1298475 Varsity \$66<sup>99</sup> EA ★  
1298505 Youth \$56<sup>99</sup> EA ★

# MacGregor LEG GUARDS

All available in BLACK ROYAL SCARLET

## DOUBLE KNEE



## SINGLE KNEE



## B62 JUNIOR SINGLE KNEE

- 9" shin plate
- Protection area of 18"
- Black only

1159318 Ages 5-8 \$54<sup>99</sup> PR ★

## B66 PREP DOUBLE KNEE

- 11" shin plate
- Full-wing ankle protectors
- Protection area of 25"

1159400 Ages 12-15 \$74<sup>99</sup> PR ★

## B68 JUNIOR DOUBLE KNEE

- 9" shin plate
- Protection area of 20"

1159431 Ages 5-8 \$68<sup>99</sup> PR ★

## B61 VARSITY DOUBLE KNEE

- 12" Shin plate
- Full ankle and calf wing

1159288 Ages 15+ \$98<sup>99</sup> PR ★

## B64 YOUTH DOUBLE KNEE

- 10" shin plate.
- Protection area of 23".

1159349 Ages 9-12 \$68<sup>99</sup> PR ★

## LEG GUARD REPLACEMENT STRAPS

Replacement straps for catcher's leg guards. Black only.

1012187 Black only \$34<sup>99</sup> DZN ★



## CATCHER'S KNEE SUPPORT

- Supports and cushions the knee, minimizing the stress on the knee in the catcher's position
- Attach to the leg guard straps
- Black only

1184747 Adult Size \$32<sup>99</sup> PR ★  
1184754 Youth Size \$32<sup>99</sup> PR ★



**\$199<sup>99</sup>**

## MacGregor

### GIRL'S FAST PITCH CATCHER'S GEAR PACK

- Package Includes:
- Adjustable catcher's combo helmet
  - MCB81 girls chest protector
  - Youth double knee leg guards
  - 4" throat protector

1186956 Ages 9 - 13 \$199<sup>99</sup> PACK ★



**\$269<sup>99</sup>**

## MacGregor

### VARSITY FAST PITCH CATCHER'S GEAR PACK

- Package includes:
- Pro style varsity catcher's helmet
  - MCB80 varsity female chest protector
  - Prep double knee leg guards
  - 4" throat protector

1186925 Ages 14+ \$269<sup>99</sup> PACK ★



## EASTON

### BLACK MAGIC 2.0 BOX SET

- Includes: Black Magic 2.0 helmet, chest protector and leg guards
- Hockey style helmet design
- Available in black ONLY

EAA165444 Youth (9-12) \$169<sup>99</sup> EA  
EAA165445 Junior Youth (6-8) \$169<sup>99</sup> EA



## 12.5" VARSITY FIELDER'S GLOVE

- Pre-oiled leather construction
- Open web design
- Quick and easy break in
- Ideal for infield or outfield

**MCFG125X** Fits Left Hand \$72<sup>99</sup> EA ★  
**MCFG125R** Fits Right Hand \$72<sup>99</sup> EA ★



## 13.5" FIELDER'S GLOVE

- Selected cowhide palm and back
- Leather lining and lacing
- Finger hole & adjustable strap
- Open web design

**BBFSPROX** Fits Left Hand \$86<sup>99</sup> EA ★  
**BBFSPROR** Fits Right Hand \$86<sup>99</sup> EA ★



## 12.5" YOUTH FIELDER'S GLOVE

- Leather palm and webbing
- Synthetic backing
- Adjustable wrist strap
- Open web design

**BBMESHXX** Fits Left Hand \$54<sup>99</sup> EA ★  
**BBMESHXX** Fits Right Hand \$54<sup>99</sup> EA ★



## 12" SCHOLASTIC FIELDER'S GLOVE

- Leather palm and webbing
- Synthetic backing
- Adjustable wrist strap
- Ideal for baseball and softball

**BBBGVARX** Fits Left Hand \$54<sup>99</sup> EA ★  
**BBBGVARR** Fits Right Hand \$54<sup>99</sup> EA ★



## 33.5" VARSITY CATCHER'S MITT

- High grade pre-oiled leather
- Exclusive major league design
- Ideal for varsity to adult players

**MCCM200X** Fits Left Hand \$107<sup>99</sup> EA ★



## 32" YOUTH CATCHER'S MITT

- Full grain leather
- Pre-oiled for easy break in
- Deep pocket and scoop toe design
- Ideal for ages 9-12.

**BBCMPROX** Fits Left Hand \$84<sup>99</sup> EA ★  
**BBCMPROR** Fits Right Hand \$84<sup>99</sup> EA ★



## 29" JUNIOR CATCHER'S MITT

- Full grain leather
- Pre-oiled for easy break in
- Deep pocket and scoop toe design
- Ideal for ages 5-8.

**BBCMLLXX** Fits Left Hand \$74<sup>99</sup> EA ★  
**BBCMLLFR** Fits Right Hand \$74<sup>99</sup> EA ★



## 33" PREP CATCHER'S MITT

- Top quality pre-oiled leather
- Scoop toe design
- Deep grip pocket
- Ideal for ages 12-15

**MCCM100X** Brown - Fits Left Hand \$84<sup>99</sup> EA ★  
**MCCM101X** Black - Fits Left Hand \$84<sup>99</sup> EA ★

## FAST PITCH



## 34" FASTPITCH CATCHER'S MITT

- Pre-oiled full grain leather w/ rawhide lacing
- Pre-formed for easy break-in
- Large softball pattern with dual "H" post web design
- Exclusive PROLOCK hook-and-loop fastener wrist closure

**MCCM300X** Fits Left Hand \$112<sup>99</sup> EA ★

## TEE BALL



## 10.5" TEE BALL GLOVE

- Soft synthetic leather construction for easy break in
- Rawhide lacing for added durability
- Adjustable wrist strap
- Ideal for t-ball and youth baseball.

**BBFGTBXX** Fits Left Hand \$39<sup>99</sup> EA ★  
**BBFGTBXX** Fits Right Hand \$39<sup>99</sup> EA ★

## FIRST BASE



## 12.5" 1ST BASE MITT

- All leather construction
- Pre-oiled for short break-in period
- Top quality first base mitt for youth through high school

**MCFB100X** Fits Left Hand \$87<sup>99</sup> EA ★  
**MCFB100R** Fits Right Hand \$87<sup>99</sup> EA ★

## BEST SELLER



## INFIELD TRAINING GLOVE

- "Pancake" style glove is ideal for infield training
- Aids in developing a quick "glove to throw" transition
- Leather construction

**1281491** Fits on left hand \$46<sup>99</sup> EA ★

# MacGregor UMPIRE EQUIPMENT



## UMPIRE ACCESSORY PACK

Boxed set includes:

- Plate brush (MCB91XXX)
- Ball bag (balls not included)
- 4-way indicator

<b>MCUMPKIT</b>	Complete Pack	\$29 <sup>99</sup> PACK ★
<b>MCB94XXX</b>	Bag Only	\$22 <sup>99</sup> EA ★
<b>MCB91XXX</b>	Plate Brush Only	\$16 <sup>99</sup> EA ★



## COMPLETE UMPIRE PACK

Box Set includes:

- B29 Pro 100 mask (MCB29BKX)
- MCB79 inside chest protector
- MCB67 leg guards
- Ball bag (balls not included)
- Plate brush
- 4-way indicator (BBUMPIN4)

<b>MCUMPSET</b>	\$234 <sup>99</sup> PACK ★
-----------------	----------------------------

## MacGregor MCB29 PRO MASK

- Hollow tubular steel frame
  - Lighter than traditional masks
  - Durable vinyl coating with extended ear and throat guard
  - Complete with harness
- Color Options: **Black.**



<b>MCB29BKX</b>	With Black Vinyl Pads	\$137 <sup>99</sup> EA ★
-----------------	-----------------------	--------------------------



## MCB78 OUTSIDE CHEST PROTECTOR

- Filled with 3" thick lightweight foam
- Adjustable shoulder straps with vinyl neck rest
- Features a built in ball pocket

<b>MCB78BXX</b>	Size: 21 1/2" L	\$92 <sup>99</sup> EA ★
-----------------	-----------------	-------------------------



## MCB79 INSIDE CHEST PROTECTOR

- Super light weight
- Wrap-around throat pad
- Extended upper shoulder ribs

<b>MCB79BXX</b>	Size: 16.5" L	\$84 <sup>99</sup> EA ★
-----------------	---------------	-------------------------



## PRO UMPIRE SHIRT

- 100% polyester
  - Reinforced front pocket
  - Rib knit collar and cuffs
- Size: **MED, LRG, XLG.**

<b>CUMPRO</b>	Navy - MD-XL	\$45 <sup>99</sup> EA ★
<b>CUMPROXX</b>	Navy - XXL	\$39 <sup>99</sup> EA ★
<b>CUMPROXXX</b>	Navy - XXXL	\$41 <sup>99</sup> EA ★
<b>LBUMP</b>	Lt Blue - MD-XL	\$41 <sup>99</sup> EA ★
<b>LBUMPXXL</b>	Lt Blue - XXL	\$39 <sup>99</sup> EA ★
<b>LBUMPXXX</b>	Lt Blue - XXXL	\$41 <sup>99</sup> EA ★



## MacGregor MCB67 UMPIRE'S LEG GUARDS

- Molded ABS construction
- Durable close-cell foam
- Fully padded ankle and instep
- 12" shin plate

<b>MCB67XXX</b>	Black only	\$64 <sup>99</sup> PR ★
-----------------	------------	-------------------------



## MacGregor UMP'S INDICATOR

- Records balls, strikes, outs

<b>BBUMPIND</b>	Plastic	\$10 <sup>99</sup> EA ★
<b>BBUMPSTL</b>	Steel	\$10 <sup>99</sup> EA ★

## 4 WAY UMPIRES INDICATOR

- Plastic indicator
- Records balls, strikes, outs and innings.

<b>BBUMPIN4</b>	\$9 <sup>99</sup> EA ★
-----------------	------------------------



## SHORT BILL UMPIRE CAP

- Polywool umpires cap with 1-1/2" short bill
- Adjustable hook/loop back
- Navy only

<b>BBUCSBNV</b>	Fits sizes 6 7/8" - 7 1/4"	\$19 <sup>99</sup> EA
-----------------	----------------------------	-----------------------



## ALL-STAR®

### PRO INTERNAL SHELL CHEST PROTECTOR

- Hardened HDPE plates for a clean low profile look
- Moldable plates in collarbone for protection and custom fit
- Matte black fabric

1459355	13"	\$109 <sup>99</sup> EA
---------	-----	------------------------

## ALL-STAR®

### PRO UMPIRE LEG GUARDS

- Available in 15", 17" and 19"
  - Lightweight, low profile design for extra protection
- Size: **15", 17", 19".**

1459356	Specify Length	\$99 <sup>99</sup> EA
---------	----------------	-----------------------





### COLLEGIATE REBOUNDER SCREEN

- Large 7' x 7' frame
- Heavy-duty 1 1/2" square, 17 gauge galvanized steel tube construction
- 2.5mm twisted knotted PE, 1.75" mesh
- Rebounder has 4 angle adjustments - 0, 10, 20 and 30 degrees - and can direct ball up into the air or onto the ground
- Can be used from either side

1378661

\$509<sup>99</sup> EA ★ S&H

### PRO MODEL

- Advanced tool lets coaches place grounders, flyballs, and line drives with pinpoint accuracy
- Made of graphite composites as professional rackets
- Treated torsion bands propel baseballs or softballs with speed and accuracy
- Perimeter weighted design
- Non-slip grip



BBACCBAT 26oz Pro Model \$99<sup>99</sup> EA



### SLIDE RITE

- The only training aid you need to teach perfect sliding techniques
- The patented design features a durable cordura cushioned mat and canvas sliding sheet to help take the fear out of sliding.

1037029

Standard Size (42"W X 12'L)

\$374<sup>99</sup> EA



### STRIKE ZONE HOME PLATE

- Great for visual focus when teaching the importance of situational pitching and hitting
- Also great for umpire training
- For use by baseball and softball players of all ages and ability
- Extended version teaches pitchers to throw to the black

1058741 Standard Version \$32<sup>99</sup> EA  
1194081 Extended Version \$46<sup>99</sup> EA



### EASTON THUNDERSTICK T10/T11

- Ideal for soft toss drills
- Can be used with plastic or regular baseballs
- Use plastic golf ball to sharpen hand-eye coordination
- 1" barrel

1264005  
1264012

Adult T10 (33"/37oz)  
Youth T11 (30"/26oz)

\$89<sup>99</sup> EA  
\$84<sup>99</sup> EA

### THE DESIGNATED HITTER

- Learn to pitch inside and how to handle hitters who crowd the plate
- Two-piece for safe and easy portability.
- Available in jersey colors: Red, Blue and Gray.
- Pro model batter stands 5'9" tall.
- Youth model batter stands 5'2" tall.



1323498 Pro Model \$439<sup>99</sup> EA  
1323504 Youth Model \$429<sup>99</sup> EA

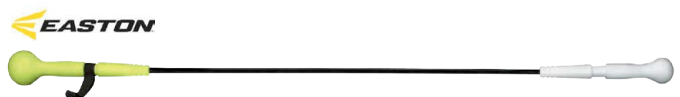

### EASTON TRAINING STICK

- The most effective & versatile batting drill device available
- Unique design features BOTH Baseball & Softball ends
- 63" length ideal for both Adult & Youth players
- Flexible shaft, texturized vibration dampening handle
- Dramatically improves hitting stance, contact and bat control

1264050

\$69<sup>99</sup> EA

**BSN SPORTS**



**BASEBALL/SOFTBALL SCOREBOOK**

- Ideal for baseball or softball with spiral at the top
- Each book scores 24 games with 16 batting positions and 9 innings per sheet
- Also includes team roster, season schedule, season totals, batting average chart, pitcher stats and simplified scoring instructions
- Pages measure 9-1/2" x 11"

**MSBASBK** Standard Size \$13<sup>99</sup> EA

**BASEBALL/SOFTBALL SCOREBOOK OVERSIZED**

- Oversize pages (14" x 11") pages for easier scoring
- 30 game scorebook with 11 batting positions
- Also includes team roster, season schedule, season totals, batting average chart, pitch count, and simplified scoring instructions.

**MCBIGBK** \$22<sup>99</sup> EA

**BASEBALL/SOFTBALL LINE-UP CARD BOOKLET**

- Four-part carbonless line-up cards
- 24 sets per booklet.
- 4 1/2" x 8 1/2"

**MCLINEUP** \$12<sup>99</sup> EA

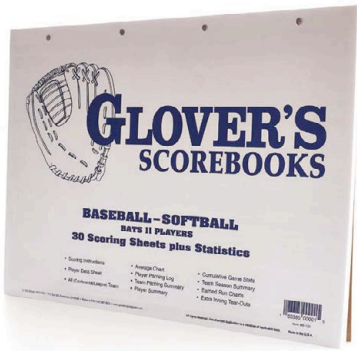

**GLOVER'S BASEBALL/SOFTBALL SCORING & STAT REFILLS**

- Includes simplified scoring instructions, batting average chart, 6-7-9 inning ERA chart, team summary pages, individual batting and pitching charts, and inning extenders.
- Sheets are 11" x 14.5"

**MSGSCST** pack of 30 \$24<sup>99</sup> PACK

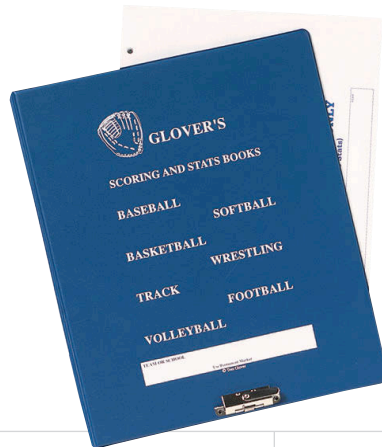

**GLOVER'S BINDER**

- Keep 24, 48, or 72 games in one binder
- Clip keeps scoresheets firmly in place
- Multiple pockets for schedules, addresses, player rosters, etc
- Scoresheets not included.

**MSGLBIND** \$34<sup>99</sup> EA



**PETERSON® SCOREMASTER**

- Simplified scoring instructions
- Wire binding
- Club size 12" x 8-1/2"
- Enables complete summary of individual batting records and pitching performance
- Suitable for softball as well as baseball
- Contains 25 games with 11 batting positions.

**MSPTRBOK** \$19<sup>99</sup> EA

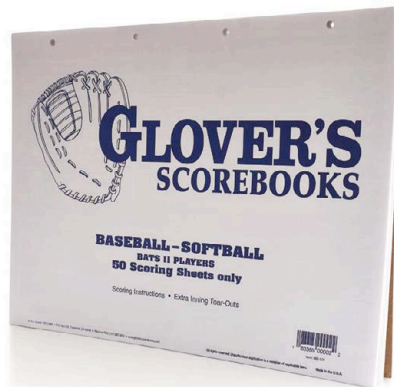

**GLOVER'S BASEBALL/SOFTBALL SCORE SHEETS**

- Includes inning extenders
- Packaged for coaches who have a computer and do not need individual stat sheets
- 11 batting positions

**MSGSCOR** pack of 50 \$29<sup>99</sup> PACK



**BASEBALL COACH'S BOARD**

- Front player line up and back baseball field writing surfaces
- Includes premium dry erase marker
- 8"W x 15 1/2"L

**1388108** \$27<sup>99</sup> EA ★



### MAJOR LEAGUE® REPLICA CAPS BY OUTDOOR CAP®

- Features 3D logo, performance material construction & adjustable tab back

**MLB350Y** Youth(6 5/8-7 1/4) **\$119<sup>99</sup>** EA  
**MLB350A** Adult(6 7/8-7 1/2) **\$119<sup>99</sup>** EA



### MAJOR LEAGUE® REPLICA VISORS BY OUTDOOR CAP®

- Performance material construction
- Adjustable tab back
- One size fits all

**MLB185** **\$119<sup>99</sup>** EA



### MLB® 1-BUTTON JERSEY

**NKN383** Adult S-3XL **\$34.99** EA  
**NKNY83** Youth S-XL **\$29.99** EA







**MLB® POLY TEE**

NKN223  
NKNY23

Adult S-3XL  
Youth S-XL

\$26.<sup>99</sup> EA  
\$24.<sup>99</sup> EA



**MLB® COTTON TEE**

NKN199  
NKNY28

Adult S-3XL  
Youth S-XL

\$19.<sup>99</sup> EA  
\$17.<sup>99</sup> EA



# GAME BALLS



NFHS  
APPROVED

**MacGregor**  
**X6000**

- Durable composite construction, wide-channel
- Indoor/Outdoor use

<b>MCX6000X</b>	Official Size (29.5")	<b>\$35<sup>99</sup></b> EA ★
<b>MCX6285X</b>	Intermediate Size (28.5")	<b>\$35<sup>99</sup></b> EA ★
<b>MCX6275X</b>	Junior Size (27.5")	<b>\$35<sup>99</sup></b> EA ★

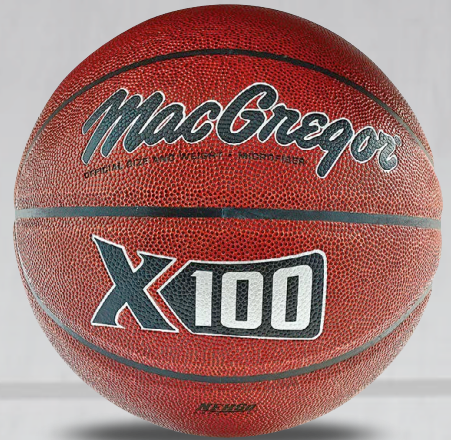

**MacGregor**

**X100**

- Microfiber composite, wide-channel
- Indoor use only

<b>MCX100XH</b>	Official Size (29.5")	<b>\$43<sup>99</sup></b> EA ★
<b>MCX128XH</b>	Intermediate Size (28.5")	<b>\$43<sup>99</sup></b> EA ★



**ELITE ALL COURT 2.0**

- Deep channels for precision control
- Competition-level composite for soft touch
- Indoor/Outdoor Use

<b>NKN100413985507</b>	Official Size (29.5")	<b>\$29<sup>99</sup></b> EA
<b>NKN100413985506</b>	Intermediate Size (28.5")	<b>\$29<sup>99</sup></b> EA
<b>NKN100413985505</b>	Junior Size (27.5")	<b>\$29<sup>99</sup></b> EA



**MacGregor**

**X6000SL**

- Synthetic construction
- Wide channel design
- Indoor/Outdoor use

<b>1297140</b>	Official Size (29.5")	<b>\$30<sup>99</sup></b> EA ★
<b>1297157</b>	Intermediate Size (28.5")	<b>\$30<sup>99</sup></b> EA ★



**Wilson**  
**NCAA LEGEND**

- Deeper rubber channels constructed for improved grip
- Soft-touch composite cover for quality feel
- Indoor/Outdoor use

<b>WLWTB0923XDEF</b>	Size 7 (29.5")	<b>\$35<sup>99</sup></b> EA
<b>WLWTB0924XDEF</b>	Size 6 (28.5")	<b>\$35<sup>99</sup></b> EA
<b>WLWTB0925XDEF</b>	Size 5 (27.5")	<b>\$35<sup>99</sup></b> EA



**SPALDING**  
**EXCEL TF-500**

- Performance composite cover
- Deep channel design for superior control
- Indoor/Outdoor use

<b>1457064</b>	Official Size (29.5")	<b>\$39<sup>99</sup></b> EA
<b>1457065</b>	Intermediate Size (28.5")	<b>\$39<sup>99</sup></b> EA
<b>1457066</b>	Junior Size (27.5")	<b>\$39<sup>99</sup></b> EA



**SPALDING**  
**REACT TF-250**

- All-surface composite leather cover
- Butyl rubber bladder for air retention
- Indoor/Outdoor use

<b>1457067</b>	Official Size (29.5")	<b>\$24<sup>99</sup></b> EA
<b>1457068</b>	Intermediate Size (28.5")	<b>\$24<sup>99</sup></b> EA
<b>1457069</b>	Junior Size (27.5")	<b>\$24<sup>99</sup></b> EA

NFHS<sup>®</sup>  
APPROVED



**Wilson**  
**EVOLUTION**

- Cushion Core carcass gives signature Evolution feel
- Microfiber composite cover for added grip & durability
- Laid-in channels are pebbled for added control
- Indoor use only

<b>1013900</b>	Size 7 (29.5")	<b>\$79<sup>99</sup></b> EA
<b>1013917</b>	Size 6 (28.5")	<b>\$79<sup>99</sup></b> EA

NFHS<sup>®</sup>  
APPROVED



**Wilson**  
**EVO NXT**

- Extended Range Tech and pebbled channels
- Advanced moisture-wicking system
- High visibility electric orange color
- Indoor use only

<b>WLWZ10033XB7</b>	Size 7 (29.5")	<b>\$99<sup>99</sup></b> EA
<b>WLWZ10033XB6</b>	Size 6 (28.5")	<b>\$99<sup>99</sup></b> EA

NFHS<sup>®</sup>  
APPROVED



**SPALDING**  
**PRECISION TF-1000**

- Deep channel design and composite cover
- Responsive cushioned sponge carcass
- Indoor use only

<b>1457060</b>	Official Size (29.5")	<b>\$69<sup>99</sup></b> EA
<b>1457061</b>	Intermediate Size (28.5")	<b>\$69<sup>99</sup></b> EA

NFHS<sup>®</sup>  
APPROVED



**SPALDING**  
**TF-1000 LEGACY**

- Microfiber composite and responsive cushioned carcass
- Deep channel design for superior control
- Indoor use only

<b>1457054</b>	Official Size (29.5")	<b>\$79<sup>99</sup></b> EA
<b>1457055</b>	Intermediate Size (28.5")	<b>\$79<sup>99</sup></b> EA

NFHS<sup>®</sup>  
APPROVED



**Nike**  
**ELITE TOURNAMENT**

- Extra-deep channels
- Durable design
- Composite exterior to help ensure grip
- Indoor use only

<b>NKN100011485507</b>	Official Size (29.5")	<b>\$50<sup>99</sup></b> EA
<b>NKN100011485506</b>	Intermediate Size (28.5")	<b>\$50<sup>99</sup></b> EA

NFHS<sup>®</sup>  
APPROVED



**Nike**  
**ELITE CHAMPIONSHIP 2.0**

- Textured in-laid channels
- Premium soft touch composite
- Non Slip logos for consistent grip
- Indoor use only

<b>NKN100408687807</b>	Official Size (29.5")	<b>\$69<sup>99</sup></b> EA
<b>NKN100408687806</b>	Intermediate Size (28.5")	<b>\$69<sup>99</sup></b> EA

NFHS<sup>®</sup>  
APPROVED



**NEW!**

**Baden**  
MAKING PLAY A BETTER GAME

**ELITE PRO**

- Advanced microfiber cover
- Perfect balance of tack and softness
- Cushion Control Technology
- Indoor use only

<b>1460974</b>	Official Size (29.5")	<b>\$79<sup>99</sup></b> EA
<b>1460975</b>	Intermediate Size (28.5")	<b>\$79<sup>99</sup></b> EA

# THE ROCK®

**COACH'S CHOICE**

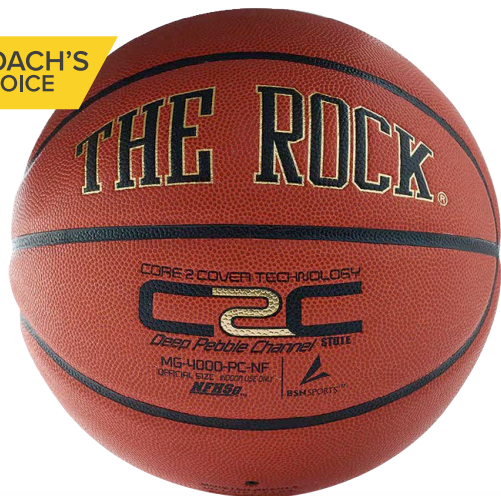

## THE ROCK® C2C

**NFHS®**  
APPROVED

- C2C Premium reinforced composite cover with sponge rubber carcass
- Double-ply Nylon wound bladder
- Deep Pebble channel design
- Indoor use only
- NFHS Approved

<b>1394967</b>	Official Size (29.5")	<b>\$52<sup>99</sup></b> EA ★
<b>1394968</b>	Intermediate Size (28.5)	<b>\$52<sup>99</sup></b> EA ★

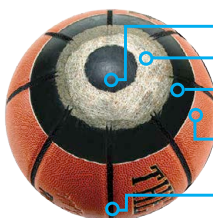

- Reinforced double ply Butyl Bladder -maximum air retention
- 100% Nylon wound -excellent shape retention and durability
- Exclusive patented sponge rubber carcass layer -extreme softness and handling improvement
- New Premium Grade Reinforced Composite material -Superior Durability. Scuff Resistant and NO Break-in Needed-Ready -Game Play!
- Unique Deep Pebble Channel design for best feel and grip



## C2C CUSTOM GAME BALL

- C2C Premium reinforced composite cover with sponge rubber carcass
- Double-ply Nylon wound bladder
- Deep Pebble channel design
- NFHS Approved
- Great way to personalize your Game basketballs
- 60 ball order minimum. Sizes may be combined in increments of 12 to meet quantity requirements
- Only one logo location per 60 ball minimum allowed. 1 or 2 Color logo included
- Delivery Clock does not begin until order is complete and artwork is approved
- Please allow 3-5 business days for proof from the factory
- Delivery in 90 to 120 days after artwork approval
- Please call for more information

<b>1394967FP</b>	Official Size (29.5")	<b>\$69<sup>99</sup></b> EA
<b>1394968FP</b>	Intermediate Size (28.5")	<b>\$69<sup>99</sup></b> EA
<b>1394977FP</b>	Junior Size (27.5")	<b>\$69<sup>99</sup></b> EA

**CALL FOR QUANTITY PRICING.**

**NFHS®**  
APPROVED

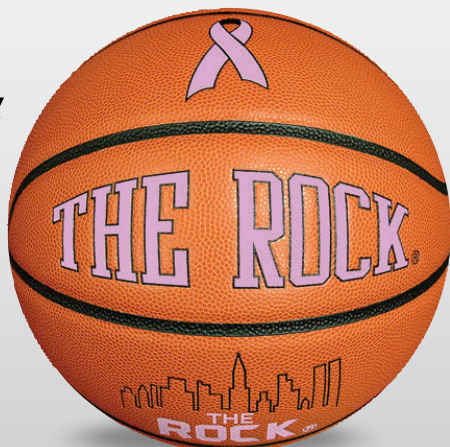

## PINK RIBBON

- Same ball as the C2C composite game ball
- Includes Pink lettering and Pink Ribbon to recognize Cancer Awareness
- Double-ply Nylon wound bladder
- Deep Pebble channel design
- Indoor use only

<b>1394971</b>	Official Size (29.5")	<b>\$52<sup>99</sup></b> EA
<b>1394972</b>	Intermediate (28.5")	<b>\$52<sup>99</sup></b> EA

# THE ROCK®



Limited colors available!

## THE ROCK® RUBBER - COLORS

- Durable rubber cover
- Enhanced pebbling
- Wide channel design
- Indoor/Outdoor use

**LD874MG4200**  
**LD874MG4300LR**

Official Size (29.5")  
Intermediate Size (28.5")

**\$13<sup>99</sup>** EA  
**\$13<sup>99</sup>** EA



## THE ROCK® AUTOGRAPH BASKETBALL

- Top quality synthetic leather cover
- Great for awards and displays
- 6 White panels

**1394976**

Official Size (29.5")

**\$44<sup>99</sup>** EA



## THE ROCK CUSTOM RUBBER BASKETBALL

- Minimum quantity of 108(Off,Inter) 100(Jr) per size. Sizes cannot be mixed to meet minimums. Must be ordered in increments of 36(Off,Inter) 50(Jr)
- Delivery Clock does not begin until order is complete and artwork is approved
- Please allow 3-5 business days for proof from the factory
- Delivery time 120 - 150 days from artwork approval
- Please call for more information

**1394981FP**  
**1394982FP**  
**1394983FP**

Official Size (29.5")  
Intermediate Size (28.5")  
Junior Size (27.5")

**\$18<sup>99</sup>** EA  
**\$18<sup>99</sup>** EA  
**\$18<sup>99</sup>** EA

**CALL FOR QUANTITY PRICING.**



## HOT SHOT BASKETBALL SHOOTING MACHINE

TAKING TRAINING TO THE NEXT LEVEL

- Colorlok Precision-Guided Technology that locks onto the shooter's color of jersey
- Automatically tracks the shooter's every move, every change in direction and every change in speed
- Delivers a Game-Like pass with realistic backspin and velocity
- Multiple Shooters and programmed drills that works any spot on the floor
- Shoot off the dribble or shoot of the catch
- Full-Speed workouts with more reps
- Electronic controls with multiple speeds and selectable shot delay
- Quiet operation; Counts number of shots made
- Light weight, easy setup and take down with one person in just a couple of minutes
- Decals available at no additional cost
- Lifetime limited warranty

**1399645**

625 lbs.

**\$10,999<sup>99</sup>** EA

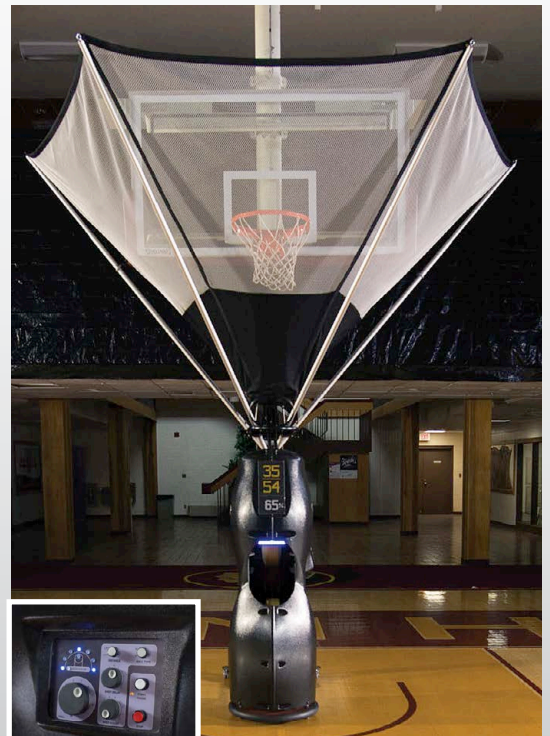

# INDOOR/OUTDOOR BALLS



## MacGregor RECRUIT

- High pebble rubber construction
- 22" circumference for younger players
- Indoor/Outdoor use

**MCMINIBB** Mini Size (22") \$13<sup>99</sup> EA ★



## SPALDING ROOKIE GEAR

- High performance composite construction
- Specifically engineered for kids ages 8 and under
- 27.5" - weighs 25% less than a standard ball
- Indoor/Outdoor use

**1273281** Multi-Color \$32<sup>99</sup> EA  
**1273274** Brown \$32<sup>99</sup> EA



## AUTOGRAPH BASKETBALL

- Laminated synthetic leather (PVC) cover
- For display purposes only
- 4 White panels
- Official Size (29.5")

**1072501** Official Size (29.5") \$42<sup>99</sup> EA ★



## Voit

### LITE 80

- Rubber construction
- 20% lighter than a standard junior sized ball
- Indoor/Outdoor use

**1291735** Junior - 27.5" \$17<sup>99</sup> EA ★



## Voit

### LITE 80 PRISM PACK

- Set includes 1 each: Blue, Green, Orange, Purple, Red and Yellow
- Rubber construction
- 20% lighter than a standard ball
- Indoor/Outdoor use

**1307030** Intermediate Size (28.5") \$89<sup>99</sup> SET OF 6 ★  
**1307047** Junior Size (27.5") \$89<sup>99</sup> SET OF 6 ★



## MacGregor BUILDER HEAVY BALL

- Heavy duty rubber construction
- Over 2 times heavier than a regulation ball
- Increase arm, wrist and finger strength
- Improves dribbling, passing and shooting
- Indoor/Outdoor use

**MCXHVME** Official Size (29.5"), 3.0 lbs. \$40<sup>99</sup> EA ★  
**MCXHVWOM** Inter Size (28.5"), 2.5 lbs. \$40<sup>99</sup> EA ★



## SPALDING TF-TRAINER WEIGHTED

- Weight: 3 lbs.
- Extends shooting range
- Improves arm, wrist and finger strength
- Indoor use only

**1459593** Official Size (29.5") \$59<sup>99</sup> EA  
**1459594** Intermediate Size (28.5") \$59<sup>99</sup> EA



## SPALDING TF-TRAINER OVERSIZED

- Exclusive composite construction
- Improves shooting accuracy
- Indoor use only

**1459595** 33" \$69<sup>99</sup> EA

# Voit RUBBER BASKETBALLS

## ENDURO

- Durable rubber construction
- Recreational play
- Indoor/outdoor use

2 Year Limited Warranty

<b>VCB2HXXX</b>	Official Size (29.5")	\$16 <sup>99</sup> EA ★
<b>VCB8HXXX</b>	Intermediate Size (28.5")	\$16 <sup>99</sup> EA ★
<b>VCB6HXXX</b>	Junior Size (27.5")	\$16 <sup>99</sup> EA ★
<b>VCB5HXXX</b>	Rookie Size (25.5")	\$16 <sup>99</sup> EA ★



# MacGregor RUBBER BASKETBALLS

## RUBBER BASKETBALLS

- Durable rubber construction
- Wide channel design
- Indoor/Outdoor use

2 Year Limited Warranty

<b>MCX35WID</b>	Official Size (29.5")	\$13 <sup>99</sup> EA ★
<b>MCX500XX</b>	Intermediate Size (28.5")	\$13 <sup>99</sup> EA ★
<b>MCX2500X</b>	Junior Size (27.5")	\$13 <sup>99</sup> EA ★

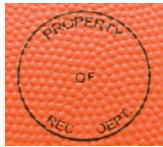

## Voit

### ENDURO CB2 REC DEPT. BASKETBALL

- Features "Property of Rec. Dept." logo
- Durable rubber construction
- Indoor/Outdoor use

2 Year Limited Warranty

**VCB2HREC**

Official Size (29.5")

\$16<sup>99</sup> EA ★

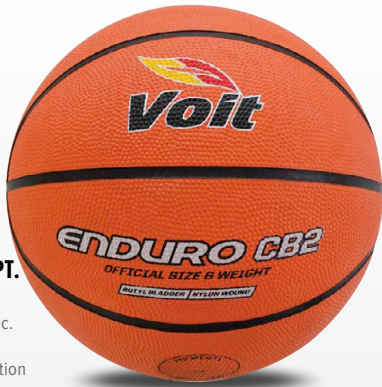

## Voit

### XB 20 THE GRIP

- 2 ply cushioned cover provides superior feel
- Super tack finish for increased ball control
- Indoor/Outdoor use

2 Year Limited Warranty

**VXB20HXX**  
**1235548**  
**1235555**

Official  
Intermediate  
Junior

\$19<sup>99</sup> EA ★  
\$19<sup>99</sup> EA ★  
\$19<sup>99</sup> EA ★



## MacGregor

### RUBBER BASKETBALL WITH YMCA LOGO

- Printed with YMCA logo
- Durable rubber construction
- Indoor/Outdoor use

2 Year Limited Warranty

**1334098**  
**1334104**  
**1334111**

Official Size (29.5")  
Intermediate Size (28.5")  
Junior Size (27.5")

\$13<sup>99</sup> EA ★  
\$13<sup>99</sup> EA ★  
\$13<sup>99</sup> EA ★



## BSN SPORTS

### COMPOSITE BASKETBALL WITH YMCA LOGO

- Composite leather ball printed with the YMCA logo
- Wide channel with a tacky grip
- Indoor/Outdoor use

**1384322**  
**1384323**  
**1384324**

Official Size (29.5")  
Intermediate Size (28.5")  
Junior Size (27.5")

\$29<sup>99</sup> EA ★  
\$29<sup>99</sup> EA ★  
\$29<sup>99</sup> EA ★

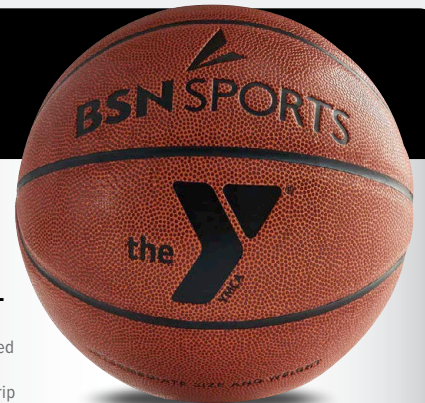



**BACKBOARD & POLE PAD INCLUDED**



**GRIZZLY ADJUSTABLE BASKETBALL SYSTEM**

- Height adjusts from 7 1/2' to 10'
- 6" x 6" square powder coated, heavy-gauge steel post
- 42" x 72" x 3/8" thick clear acrylic regulation-size backboard welded to a heavy steel frame for extra support
- Height adjustment handle can be locked in place with a long shackle padlock (not included)
- Includes heavy-duty breakaway goal, nylon net, black post pad and backboard padding
- Uses J-bolt anchoring system

**1291247** 450 lbs. **\$3,499<sup>99</sup>** EA ★



**ULTIMATE JR. SYSTEM**

- 5" x 5" square powdered coated steel pole
- 5" x 5" square extension arm places backboard 36" away from pole
- Aluminum fan backboard w/breakaway goal - 35 1/2"H x 54"W
- Steel rectangular backboard w/flex goal - 42"H x 60"W

**1388087** Fan Aluminum **\$2,919<sup>99</sup>** EA   
**1388088** Rectangular Steel **\$2,999<sup>99</sup>** EA



**ULTIMATE™ OUTDOOR GLASS SYSTEM**

- Same features as Ultimate system (871444XX) but with full size 42" x 72" competition glass backboard, heavy-duty flex goal, nylon net, post pad and backboard padding
- Lifetime guarantee on pole, five year limited guarantee on backboard, one year limited guarantee on goal and padding

**Lifetime Warranty**  
**987344XX** 600 lbs. **\$6,679<sup>99</sup>** EA



**ULTIMATE™ POLE PADDING**

- Protect players from injury caused by contact with pole
- 1" thick and 74" high vinyl covered foam
- Velcro attachment straps

**870444XX** Black only **\$1,059<sup>99</sup>** EA



**ULTIMATE™ FIXED HEIGHT SYSTEM**

- 6" x 6" square powder coated, heavy-gauge steel post
- 42" x 60", 12 gauge steel, white powder coated backboard with graffiti-resistant finish and safety rolled edges to eliminate sharp contact points
- 60" safe play area
- Includes 5/8" double ring, ultimate playground goal with exclusive no-fail netlock system and nylon net (post pad not included)

**Lifetime Warranty**  
**871444XX** 500 lbs. **\$4,299<sup>99</sup>** EA



**NEW!**  
  
**ULTIMATE HANGTIME ADJUSTABLE SYSTEM**

- Heavy duty right angle crank can be locked to avoid unauthorized height adjustment with optional BALOCKHT HangTime rim height locking device
  - 6" square heavy wall steel poles and unbreakable clear polycarbonate or tempered glass backboards
  - All HangTime adjustable systems come standard with outdoor breakaway goal
- Size: **42x60 Glass, 42x60 Poly, 42x60 Steel, 42x72 Glass, 42x72 Poly, 42x72 Steel.**

**1460983** Specify Size **\$3,399<sup>99</sup>** EA





**OUTDOOR VERTICAL SYSTEM**

- Built to withstand the use of your outdoor playground
- Available with 4' safe play area with with either 4 1/2" or 3 1/2" O.D. vertical galvanized steel pole
- Cast aluminum fan-shaped backboard with continuous reinforcing ribs
- White powder coated 54" x 39" board with shooters target
- Includes durable economy goal with nylon net
- Goal mount centers 5" x 5"

**Limited Lifetime Warranty**

PR50474	4' Extension w/Economy Rim - 4 1/2" Post	\$2,749 <sup>99</sup> EA	
PR50473	4' Extension w/Economy Rim - 3 1/2" Post	\$1,969 <sup>99</sup> EA	



**OUTDOOR GOOSENECK SYSTEM**

- These units are built to withstand the heavy duty use of your outdoor playground
- The goal, backboard and one-piece post bolt together forming a single solid unit
- Available with 4' safe play area with 4.5" O.D. galvanized steel gooseneck pole or 5' safe play area with 4.5" O.D. galvanized steel gooseneck pole
- Cast fan-shaped aluminum backboard with continuous reinforcing ribs
- White powder coated 54" x 39" board with shooters target
- Choose from 3 rim options: Double rim with Chain Net, Standard rim with Nylon net or Breakaway Goal with Nylon Net
- Goal mount centers 5" x 5" Limited Lifetime Warranty

PR50059	5' Extension w/Double Rim & Chain Net	\$1,834 <sup>99</sup> EA	
PR50058	4' Extension w/Double Rim & Chain Net	\$1,679 <sup>99</sup> EA	
PR50055	5' Extension w/Standard Rim & Nylon Net	\$1,799 <sup>99</sup> EA	
PR50054	4' Extension w/Standard Rim & Nylon Net	\$1,699 <sup>99</sup> EA	
PR50057	5' Extension w/Breakaway Rim & Nylon Net	\$1,809 <sup>99</sup> EA	
PR50056	4' Extension w/Breakaway Rim & Nylon Net	\$1,739 <sup>99</sup> EA	



**MEGA DUTY BASKETBALL UNITS**

- 5 9/16" O.D. galvanized steel pole
- 72" safe play area
- Goal mounts directly through backboard to pole to virtually eliminate stress on backboard when hanging occurs
- Heavy 1 5/8" backboard braces
- 48" in-ground bury
- System includes ultimate double rim, nylon net, backboard, backboard braces and post

**Lifetime Warranty**

1. 20020077	Steel Rectangular Backboard - 42" x 60"	\$4,599 <sup>99</sup> EA	
2. 20020075	Aluminum Fan Backboard - 35" x 54"	\$3,449 <sup>99</sup> EA	
3. 20020078	Polycarbonate Backboard - 42" x 54"	\$5,199 <sup>99</sup> EA	



**ALUMINUM FAN BACKBOARD**

- Cast aluminum fan-shaped backboard with continuous reinforcing ribs
- White powder coated 54" x 39" board with shooters target
- Front mount Economy Goal with nylon net
- Standard 20" x 35" backboard mounting
- Universal goal mounting pattern
- Hardware included when purchasing board and goal together

**Lifetime Warranty**

PR232202	Backboard w/Super Goal and Nylon Net	\$999 <sup>99</sup> EA	
PR232A	Backboard Only	\$949 <sup>99</sup> EA	



**CLUB COURT PORTABLE BASKETBALL SYSTEMS**

- 36" x 54" tempered glass backboard with break-a-way goal
- Spring assisted goal height adjustment from 6 1/2' to 10' with goal height indicator labels
- 1 1/2" thick, black padded front base and riser
- Oversized ballast box holds either 425 lbs. or 850 lbs. of ballast (not included)
- Goal mounts directly to extension arm, eliminating stress on backboard during play
- Folds without tools for transport on non-marking casters (fits through 78" high double doors)

**2 Year Limited Warranty**

1299373 Super Club Court \$5,199<sup>99</sup> EA

**ACRYLIC CLUB COURT**

- 32" x 48" acrylic backboard
- Flex goal
- 36" safe play area when goal is at 10'
- Requires 425 lbs. of ballast (not included)

833444XX \$3,744<sup>99</sup> EA



**MICRO-Z54 PORTABLE BASKETBALL STANDARD**

- Highly portable system with 4' boom
- Rolls easily on four casters and locks in place with a brake lever
- Spring assisted height adjustment from 7' to 10'
- Black padded front base and riser
- Backboard padding not included
- Includes a 32" x 54" acrylic backboard and an official size breakaway goal with nylon net
- Requires 250 lbs. of ballast (not included)
- Not for main court use or dunking activities

**2 Year Limited Warranty**

1393447 Complete Unit \$3,999<sup>99</sup> EA   
 1393448 Replacement Backboard \$799<sup>99</sup> EA   
 1393449 Replacement Breakaway Goal \$209<sup>99</sup> EA



**FASTBREAK 960 PORTABLE BASKETBALL STANDARD**

- Features goal height adjustment from 7' to 10'
- Extension arm provides 6' safe play area at 10' goal height
- Multi-piece base padding included (black)
- Folds easily by two people in minutes
- Includes 60" x 36", 3/8" thick high performance, aluminum framed acrylic backboard, Pro Image™ breakaway goal and nylon net
- Requires 300 lbs. of ballast (not included)

**2 Year Limited Warranty**

1048216 \$4,599<sup>99</sup> EA

**FASTBREAK 940 PORTABLE BASKETBALL STANDARD**

- Same features as 960 model but with a smaller 54" x 32" aluminum framed acrylic backboard

**2 Year Limited Warranty**

1048223 \$3,999<sup>99</sup> EA



**T-REX™ ADJUSTABLE/PORTABLE SYSTEMS**

- Design makes one person setup and storage easy and fast
- Utilizes the same spring technology used in collegiate and professional arenas throughout the country
- Direct mount 42" x 72" glass backboard
- TruFlex Competition Breakaway Goal
- Adjustable from 5' to 10' (6" increments)
- Self-lubricating bronze bearings used in all pivot points
- Fully padded base (2" thick - covers 78" high)
- Duraskin™ backboard padding

895444XX T-Rex 66 System \$11,429<sup>99</sup> EA   
 20026189 T-Rex 96 System \$12,769<sup>99</sup> EA



**QWIKCHANGE™ SHOOTING STATION**

- Entire system mounts easily to the wall with two load spreading struts
- No ladders or tools
- 7 1/2' to 10' goal height adjusts from the playing surface in 6" increments
- Mounts indoors/outdoors
- 22" safe play area at 10'
- Wall mounting hardware not included

<b>20020250</b>	1) Fan Shaped Graphite 36" x 48"	<b>\$1,346<sup>99</sup></b> EA	<b>S&amp;H</b>
<b>1187687</b>	2) Rectangular Acrylic 32" x 48"	<b>\$1,734<sup>99</sup></b> EA	<b>S&amp;H</b>



**GYMNASIUM™ HEIGHT ADJUSTMENT SYSTEMS**

- Adjusts rim height from 10' to 8' and anywhere between using hand crank operated from the floor
- Easy-to-read height indicator labels
- Heavy duty 2" square silver powder coated steel structure moves backboard 4 1/4" closer to the free throw line
- Most fan boards have 20" x 35" mounting
- Most 42" x 72" boards have 36" x 62" mounting
- Most 48" x 72" boards have 42" x 62" mounting

<b>5043XXXX</b>	20" x 35" Fan Mounting	<b>\$2,404<sup>99</sup></b> EA	<b>S&amp;H</b>
<b>5042XXXX</b>	36" x 62" Mounting	<b>\$2,574<sup>99</sup></b> EA	<b>S&amp;H</b>
<b>5044XXXX</b>	42" x 62" Mounting	<b>\$2,599<sup>99</sup></b> EA	<b>S&amp;H</b>



**6-IN-1 EASY-UP™ YOUTH MINI GOAL**

- Can be adjusted to 6 different heights (6 1/2' to 9')
- Lowers rim and moves rim 24" closer to free throw line; full sized rim
- Total system weight is less than 40 lbs.
- 32" x 48" backboard is molded of high impact ABS plastic
- Ships assembled and fits any style goal
- Not suitable for dunking or hanging from goal

<b>1295825</b>	<b>\$1,214<sup>99</sup></b> EA
----------------	--------------------------------



**ZIP CRANK™ ADJUSTABLE SHOOTING STATION**

- 36" x 54" x 1/2" thick acrylic backboard looks and plays much like higher priced glass systems
- Easy to operate, removable hand crank adjusts goal height from 7 1/2' to 10'
- Competition design breakaway goal and direct goal mount design makes backboard virtually unbreakable during normal play
- Steel structure mounts to wall by means of three load spreading struts
- Mounts indoors/outdoors and has 30" safe play area at 10'
- Wall mounting hardware not included

<b>20020300</b>	<b>\$2,999<sup>99</sup></b> EA	<b>S&amp;H</b>
-----------------	--------------------------------	----------------



**QWIKCHANGE™ PLAYGROUND SYSTEM**

- Height adjusts from 7 1/2' to 10' (6" increments) without unbolting the backboard
- Includes 72" high black pole safety padding, reflex rim and net
- 34" base weighs 340 lbs. for stability
- Heavy duty 3 1/2" galvanized steel pole
- Base has (2) 3" heavy-duty wheels for easy transport
- Outdoor use only

<b>20020801</b>	Fan Shaped Graphite 36" x 48"	<b>\$2,499<sup>99</sup></b> EA	<b>S&amp;H</b>
<b>20028011</b>	Rectangular Acrylic 32" x 48"	<b>\$2,709<sup>99</sup></b> EA	<b>S&amp;H</b>



**PLAYTIME™ BASKETBALL STANDARD**

- Telescoping adjustment from 6'6" to 8' (6" increments)
- 34" white powder coated formed steel base
- Rubber rim protects the floor
- Goal, net, blue protective pad and hardware included
- Built-in 100 lb. ballast
- Indoor or outdoor use

<b>20020803</b>	<b>\$1,773<sup>99</sup></b> EA	<b>S&amp;H</b>
<b>1271676</b>	Replacement Backboard	<b>\$389<sup>99</sup></b> EA

# INDOOR/OUTDOOR BACKBOARDS

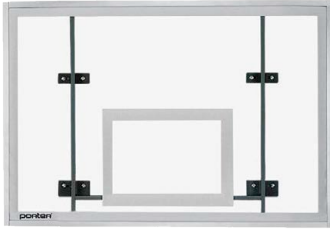

**porter**

## PRO-STRUT CONVERSION GLASS BACKBOARD

- 42" x 72" rectangular glass backboard
- Two vertical struts with fan shaped backboard mounting centers include all the necessary hardware
- Official white border and target area are fired into the glass
- Backboard padding is not included but is recommended for player safety.
- Goal sold separately

### Lifetime Warranty

PR205A \$1,449<sup>99</sup> EA

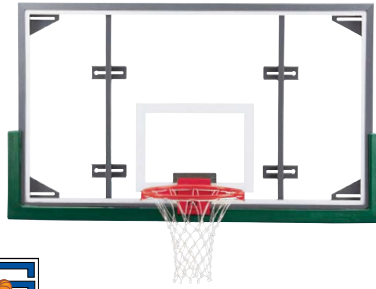

## ARG CONVERSION GLASS BACKBOARD

- 42" x 72" steel framed backboard only
- Replaces fan shaped or small glass backboards
- Designed for direct, three or four point mounting with steel mounting plates which strengthen backboard
- Frame pre-drilled for padding (not included)
- 5" x 4" goal mount pattern (goal sold separately)
- Meets NCAA and NFHS specifications

### Lifetime Warranty

1237436 Backboard Only - 220 lbs. \$2,199<sup>99</sup> EA



## CONVERSION GLASS BACKBOARDS

- Convert courts from fan-shaped to rectangular glass backboards
- Converts without a new mounting structure
- Ready to install with no drilling or relining of court
- Pre-drilled for DuraSkin<sup>®</sup> padding (not included)
- Mounting hardware included
- Goal sold separately

### Lifetime Warranty

5155XXXX 42" x 72" - 223 lbs. \$1,635<sup>99</sup> EA   
 5154XXXX 48" x 72" - 246 lbs. \$1,814<sup>99</sup> EA



## STEEL REAR MOUNT BACKBOARD

- 35" x 54" backboard with 4" x 3 5/8" goal mounting pattern
- Standard 20" x 35" mounting
- Vibration-free unit stabilized by 12 gauge horizontal and 10 gauge vertical channels
- Phosphate treated and powder coated for maximum protection against weathering

1140118 Backboard with Goal and Net \$799<sup>99</sup> EA   
 1140125 Backboard Only w/Target and Border \$679<sup>99</sup> EA   
 1140132 Backboard Only - Solid White \$659<sup>99</sup> EA



## STEEL FRONT MOUNT BACKBOARD

- 35" x 54" steel backboard with 5" x 4 1/2" goal mounting pattern
- Standard 20" x 35" mounting
- Phosphate treated and powder coated for maximum protection against weathering
- Goal sold separately

1140149 Includes Shooter's Square \$699<sup>99</sup> EA   
 1140156 Solid White Backboard \$679<sup>99</sup> EA



## ULTIMATE<sup>®</sup> STEEL BACKBOARD

- 42" x 60" backboard
- Graffiti resistant finish
- 5" X 5" goal mounting pattern
- 20" X 35" mounting brackets
- Attaches to any current fan-shaped ceiling or wall mounted structure

### 10 Year Limited Warranty

5156XXXX Backboard Only \$1,878<sup>99</sup> EA



## FRONT MOUNT BACKBOARD

- 35 1/2" x 54" cast aluminum backboard
- White powder coated finish with orange shooters square
- Heavy support ribs
- Goal sold separately

### Lifetime Warranty

1376346 Backboard Only \$899<sup>99</sup> EA

# INDOOR BACKBOARDS



## REGULATION SIZE ACRYLIC BACKBOARD

- Heavy duty 3/8" thick acrylic backboard
- Heavy duty welded and powdercoated steel tubular uni-frame with struts for added board support
- Regulation size 42" x 72"
- Standard 36" x 62" backboard mounting pattern
- 5" x 5" goal mounting pattern

**2 Year Limited Warranty**

1245943 Backboard Only \$1,249<sup>99</sup> EA



## AFRG - ALUMINUM FRAME GLASS BOARD

- Heavy duty corner brackets and direct to goal mounting allows for disbursement of stress along the extruded frame
- 1/2" tempered glass with fired-in target and border
- 5" x 4" goal mounting pattern
- Meets NCAA, NAIA & NFHS specifications

**Lifetime Warranty**

1091974 42" x 72" Backboard Only \$1,449<sup>99</sup> EA   
 1237429 48" x 72" Backboard Only \$1,299<sup>99</sup> EA

**COACH'S CHOICE**

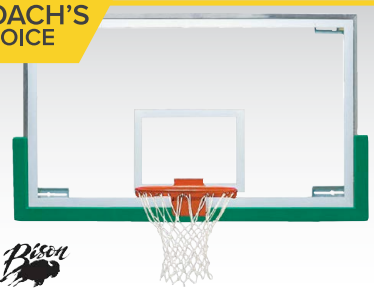

## HIGH SCHOOL BACKBOARD PACKAGE

- 42" x 72" glass backboard
  - TruFlex Breakaway rim
  - DuraSkin padding - 16 color options
- Color Options: **Black, Brown, Burnt Orange, Cardinal, Columbia Blue, Forest, Gold, Grey, Kelly, Maroon, Navy, Orange, Purple, Royal, Scarlet, Vegas Gold.**

**Lifetime Warranty**

1376347 Backboard, Goal and Padding \$2,499<sup>99</sup> EA   
 5028XXXX 42" x 72" Backboard Only \$1,688<sup>99</sup> EA   
 5027XXXX 48" x 72" Backboard Only \$1,757<sup>99</sup> EA



## SPALDING

### SUPERGLASS™ COLLEGIATE PACKAGE

- Includes 1/2" tempered glass center strut backboard, Slam Dunk goal with tube-tie net system, and bolt-on backboard padding
- 42" x 72" glass backboard
- 36" x 63" mounting bracket spacing
- Meets all NCAA, NFHS and FIBA specifications

Color Options: **Black, Forest Green, Gold, Grey, Kelly, Maroon, Navy, Orange, Purple, Royal, Scarlet.**

**7 Year Limited Warranty**

1048292 Backboard, Goal and Padding \$2,699<sup>99</sup> PACK



## UNBREAKABLE™ SHORT GLASS BACKBOARD

- 42" x 72" with 1/2" thick tempered glass
- Built-in goal leveling device
- 35 1/2" x 62" mounting bracket spacing and 5" x 4" goal mounting pattern
- Pre-drilled for Duraskin™ padding
- Note: The glass itself is not unbreakable. Breakage in transit, during mounting, malicious acts, or deliberate attempts to damage are not covered under this guarantee.

**Lifetime Warranty**

5150XXXX Backboard with Padding \$2,159<sup>99</sup> EA   
 5151XXXX Backboard Only \$1,732<sup>99</sup> EA



## UNBREAKABLE™ TALL GLASS BACKBOARD

- 48" x 72" with 1/2" thick tempered glass
- Built-in goal leveling device
- 42" x 62" mounting bracket spacing and 5" x 5" goal mounting pattern
- Pre-drilled for Duraskin™ padding (not included)
- Note: The glass itself is not unbreakable. Breakage in transit during mounting, malicious acts, or deliberate attempts to damage are not covered under this guarantee.

**Lifetime Warranty**

1302776 Backboard Only \$1,699<sup>99</sup> EA



## PORTER®

### CENTER STRUT GLASS BACKBOARD PACKAGE

- Official size backboard 42" x 72", goal mount centers 5" x 4.5"
- Three point support frame with direct goal mount (Center-Strut) support structure
- PR00208000 does not include backboard padding
- Package includes: 42" x 72" Center Strut Glas Backboard, Powr Flex Competition Goal, and Pro Pad backboard padding

**5 Year Limited Warranty**

PR20810C Backboard Package \$2,099<sup>99</sup> SET   
 PR00208000 Backboard Only \$1,399<sup>99</sup> EA



## PORTER®

### PRO STRUT GLASS BACKBOARD PACKAGE

- Official size backboard 42" x 72"
- Vertical Center-Strut goal support and four corner attachment support frame
- Allows installation on wall-mount units and double drop overhead supported units
- PR00204000 does not include backboard padding
- Package Includes: 42" x 72" Pro Strut Glass Backboard, Powr Flex Competition Goal and Pro Pad board padding

**5 Year Limited Warranty**

PR20410C Backboard Package \$2,199<sup>99</sup> SET   
 PR00204000 Backboard Only \$1,499<sup>99</sup> EA



**FRONT MOUNT ECONOMY GOAL**

- Front mount, 5/8" solid steel, powder coated single rim
- 5/8" reinforcing bars
- Continuous no-tie net attachment
- 5" x 5" Goal Centers
- Includes nylon net and mounting hardware
- Indoor/Outdoor use

**PR00235000** \$199<sup>99</sup> EA



**MacGregor**  
**GAME SERIES FLEX GOAL**

- Competition level flex rim
- Tube-tie net attachment
- 5" x 5" goal mounting pattern
- Powder coated finish
- Includes Anti-whip net and mounting hardware
- Meets NCAA and NFHS specifications
- Indoor/Outdoor use

**5 Year Limited Warranty**  
**PR236H00** \$219<sup>99</sup> EA



**FRONT MOUNT FLEX GOAL**

- Front mount, 5/8" solid steel, powder coated single rim
- Flex design with 15 deflection-auto return
- Continuous no-tie net attachment
- Universal goal mounting pattern
- Includes net and mounting hardware
- Indoor/Outdoor use

**5132XXXX** \$409<sup>99</sup> EA



**MacGregor**  
**FRONT MOUNT DOUBLE RIM FLEX GOAL**

- Double 5/8" solid steel, powder coated rim
- Flex design with 15 degree deflection auto return
- Universal goal mounting pattern
- Includes net and mounting hardware
- Indoor/Outdoor use

**Lifetime Warranty**  
**PR238H00** \$267<sup>99</sup> EA



**SPALDING**  
**ROUGHNECK GORILLA GOAL**

- Front mount, 5/8" solid steel, powder coated single rim
- 5/8" reinforcing bars
- Continuous no-tie net attachment
- Universal mounting pattern
- Includes net and mounting hardware
- Indoor/Outdoor use

**3213XXXX** \$269<sup>99</sup> EA



**porter**  
**DOUBLE RIM PLAYGROUND GOAL**

- 5/8" top ring, 1/2" bottom ring, powder coated solid steel
- Two rim support braces for strength
- Universal goal mounting pattern
- Includes net and mounting hardware
- Outdoor use

**Lifetime Warranty**  
**PR00202H00** Nylon Net \$182<sup>99</sup> EA  
**PR00202NET** Chain Net \$186<sup>99</sup> EA



**240 - DOUBLE RIM FRONT MOUNT SUPER GOAL**

- Double rings (5/8" top ring, 1/2" bottom ring)
- Continuous no-tie net attachment
- 4" x 5" and 5" x 5" mounting patterns
- Includes net and mounting hardware
- Outdoor use

**2 Year Limited Warranty**  
**1237474** \$219<sup>99</sup> EA



**66T - REAR MOUNT INSTITUTIONAL GOAL**

- Rear mount, 5/8" solid steel, powder coated single rim
- No-tie net attachment
- 4" x 3 7/8" mounting pattern
- Includes net and mounting hardware
- Outdoor use

**20015034** \$189<sup>99</sup> EA

# INDOOR GOALS



## COLLEGIATE 2000 BREAKAWAY GOAL

- Front mount, 5/8" solid steel, powder coated single rim
- Adjustable positive lock mechanism allows precise fly-back action
- Continuous no-tie net attachment
- 4" x 5" or 5" x 5" goal mounting pattern
- Includes net and mounting hardware
- Meets NCAA, NFHS and NAIA specifications
- Indoor use only

**4 Year Limited Warranty**

5038XXXX \$349<sup>99</sup> EA



## PROTECH<sup>®</sup> BREAKAWAY GOAL

- Front mount, 5/8" solid steel, powder coated single rim
- Traditional ball and socket positive lock mechanism
- Continuous no-tie net attachment
- 4" x 5" and 5" x 5" goal mounting patterns
- Includes net and mounting hardware
- Meets NCAA and NFHS specifications
- Indoor use only

**3 Year Limited Warranty**

354444XX \$427<sup>99</sup> EA



## ELITE<sup>™</sup> BREAKAWAY GOAL

- Front mount, 5/8" solid steel, powder coated single rim
- Low maintenance breakaway mechanism with padded cover-plate
- Six point lubrication system for smooth action
- Net hideaway attachment system
- 4" x 5" and 5" x 5" goal mounting patterns
- Includes net and mounting hardware
- Meets NCAA and NFHS specifications
- Indoor use only

**5 Year Limited Warranty**

511XXXX \$544<sup>99</sup> EA



## 1000 SCHOLASTIC BREAKAWAY GOAL

- Front mount, 5/8" solid steel, powder coated single rim
- Unique stack spring construction for true rebound
- Continuous no-tie net attachment
- 4" x 5" goal mounting pattern
- Includes net and mounting hardware
- Meets NCAA, NFHS and NAIA specifications
- Indoor use only

**2 Year Limited Warranty**

1237443 \$299<sup>99</sup> EA



## SPALDING

### SLAMMER COMPETITION 180-GOAL

- Front mount, 5/8" solid steel, powder coated single rim
- Adjustable tension 180° side and front flex action
- Easy-glide net attachment system
- Universal mounting pattern
- Includes net and mounting hardware
- Meets NFHS specifications
- Indoor use only

**2 Year Limited Warranty**

1008210 \$464<sup>99</sup> EA  
1388019 #2 Net Cable \$48<sup>99</sup> EA



## SPALDING

### SLAM DUNK PRO GOAL

- Front mount, 5/8" solid steel, powder coated single rim
- Top adjust positive lock release mechanism
- Easy glide #2 net attachment system
- Universal goal mounting pattern
- Includes net and mounting hardware
- Meets NBA, NCAA and NFHS specifications
- Indoor use only

**7 Year Limited Warranty**

1007923 \$464<sup>99</sup> EA  
1388019 #2 Net Cable \$48<sup>99</sup> EA



## PORTER

### POWR-FLEX GOAL

- NCAA Division 2/3 and NFHS Compliant
- 5" x 4" to 5" x 4.5" Mount Pattern
- Tube Tie Net Attachment
- Indoor Use Only

**5 Year Limited Warranty**

PR22302 \$749<sup>99</sup> EA



## PORTER

### TORQ FLEX COMPETITION GOAL

- NCAA and NFHS Compliant
- 5" x 4" to 5" x 4.5" Mount Pattern
- Tube Tie Net Attachment
- Indoor use only

**5 Year Limited Warranty**

PR240180 \$579<sup>99</sup> EA



## PORTER

### ULTRA-FLEX BREAKAWAY GOAL

- Breakaway Rim
- 5" x 4" to 5" x 4.5" Mount Pattern
- Includes Net & Mounting Hardware
- Tube Tie Net Attachment

**3 Year Limited Warranty**

1388578 \$439<sup>99</sup> EA



**BRUTE**

- 288 gram, 12 loop, braided nylon

**SNBBN288Y** \$10<sup>49</sup> EA ★

**STANDARD DUTY**

- 144 gram, 12 loop, braided nylon

**SNBBN144Y** \$7<sup>49</sup> EA ★

**HEAVY DUTY ANTI-WHIP**

- 145 gram, 12 loop, braided nylon

**SNBBNWIPIY** \$9<sup>49</sup> EA ★

**TRADITIONAL**

- 90 gram, 12 loop, braided nylon

**SNBBN90XY** \$6<sup>49</sup> EA ★



**PREMIUM STEEL PLAYGROUND NET**

- Zinc plated chain is three-times heavier than typical chain nets
- All links are welded into closed loops to prevent separation when chains are stretched during play
- Includes heavy-duty S-hooks for attachment to any style rim

**2 Year Limited Warranty**  
**504444XX** \$102<sup>99</sup> EA

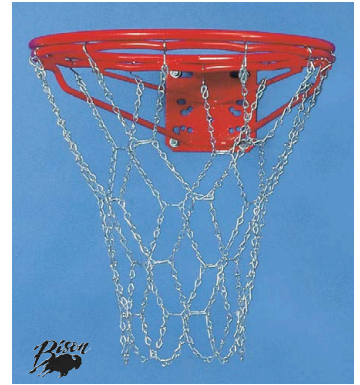

**STEEL CHAIN NO-TIE SUPER NET**

- 12 loop, zinc plated galvanized steel provides protection from weather
- Includes heavy-duty "S" hooks for attachment to any style rim

**SNBBSTLN** \$52<sup>99</sup> EA



**BRAIDED POLY NET**

- 3mm, 12 loop, braided polyethylene
- 400% more durable than nylon
- Designed for outdoor use

**SNBBNPBRY** \$9<sup>49</sup> EA ★



**WEB OUTDOOR NET**

- Flat strap design improves outdoor durability while maintaining the feel of traditional nylon nets
- Triple-stitched with non-rotting nylon thread
- Includes heavy-duty S-hooks for attachment to any style rim

**SNBBN505** \$44<sup>99</sup> EA ★



**MOUNTS AND BRACKETS**



**BISON ADJUSTO-BRACKET BASKETBALL GOAL MOUNT**

- Simply attach the Adjusto-Bracket to any flat surface and slide your goal into place to create a basketball play area
- For use on brick, wood, block or tile
- Goal not included
- 8 1/2"H x 7"W - 2 lbs.

**4998XXXX** \$141<sup>99</sup> EA

**GOAL FOR ADJUSTO BRACKETS**

- For use with single or double Adjusto-Bracket goal mounts

**5004XXXX** \$117<sup>99</sup> EA



**DOUBLE ADJUSTO-BRACKET GOAL MOUNT**

- Allows 12" height adjustment on one bracket to accommodate different age/height requirements
- 17"H x 8 1/2"W - 4 lbs.

**4997XXXX** \$212<sup>99</sup> EA



## BACKBOARD PADDING



### SAF-GUARD CUSHION EDGE BACKBOARD PADDING

- Soft, durable backboard padding made from high density polyurethane foam with tough outer skin
- Fits most standard 72" wide glass or acrylic backboards
- Reinforced, pre-drilled bolt holes for easy installation (mounting hardware included)
- Meets NCAA and NFHS specifications
- Indoor use only

Color Options: **Black, Grey, Navy, Red, Royal Blue.**

**BB72**

Specify Color

\$234<sup>99</sup> EA ★



### DURASKIN BACKBOARD SAFETY PADDING

- Fits every manufacturers' official 72" backboard but might require frame drilling on non-Bison backboards (will not work with Zip Crank)
- Reinforced, pre-drilled bolt holes for easy installation (mounting hardware included)
- Meets NCAA, FIBA and NFHS specifications
- Indoor use only
- Rectangular color options: **Black, Brown, Burnt Orange, Cardinal, Columbia Blue, Forest Green, Gold, Grey, Kelly Green, Maroon, Navy, Orange, Purple, Royal, Scarlet, Vegas Gold**

**10 Year Limited Warranty**

**5054XXXX**

For Rectangular Backboards

\$346<sup>99</sup> EA



### PRO-MOLD BACKBOARD PADDING

- Soft, durable backboard padding made from high density polyurethane
- Fits most standard 72" wide glass or acrylic backboards
- Reinforced, pre-drilled holes for installation
- Mounting hardware included
- Meets NCAA, NBA & NFHS specifications
- Indoor use only

Color Options: **Black, Dark Green, Gold, Grey, Kelly, Maroon, Navy, Purple, Royal, Scarlet.**

**1092000**

Specify Color

\$279<sup>99</sup> EA



### PRO BOLT-ON BACKBOARD PADDING

- Extremely durable molded padding which meets all NBA, NCAA, NFHS and FIBA requirements.
- Choose from 12 colors

**3 Year Limited Warranty**

Color Options: **Black, Dark Green, Grey, Kelly Green, Light Blue, Maroon, Navy, Orange, Purple, Red, Royal, Yellow Gold.**

**1383915**

Specify Color

\$319<sup>99</sup> EA



# COACHES EQUIPMENT



## MARK V BASKETBALL SCOREBOOK

- Includes 30 games, 15 player spots, 3-point scoring, team roster, season schedule, season summary, and simplified scoring instructions
- 8 1/2" x 11" spiral bound with hard cover

**MSMARKBK** \$14<sup>99</sup> EA

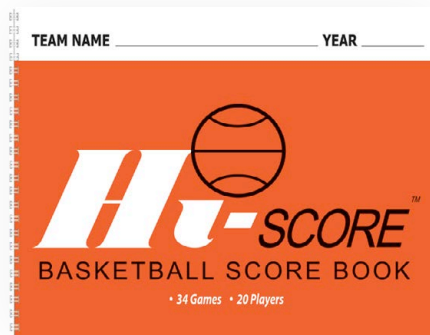

## HI-SCORE BASKETBALL SCOREBOOK

- Includes 34 games, 20 players per roster, scoring by quarters or halves, and simplified scoring instructions with illustrated example
- 8.5" x 11" wire-O bound

**1458091** \$14<sup>99</sup> EA

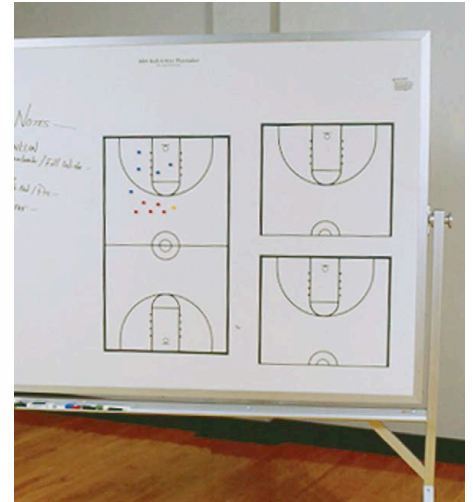

## BASKETBALL PLAYMAKER DRY ERASE BOARDS

- Heavy duty aluminum framed magnetic 48" x 72" dry erase board
- 1 full court and 2 half courts (roll-a-way version has blank space on opposite side)
- Includes (4) dry erase pens, magnetic pieces with vinyl numbering system and an eraser

**1298840** Roll-A-Way Version \$1,499<sup>99</sup> EA **S&H**  
**1366512** Wall Mount Version \$849<sup>99</sup> EA **S&H**

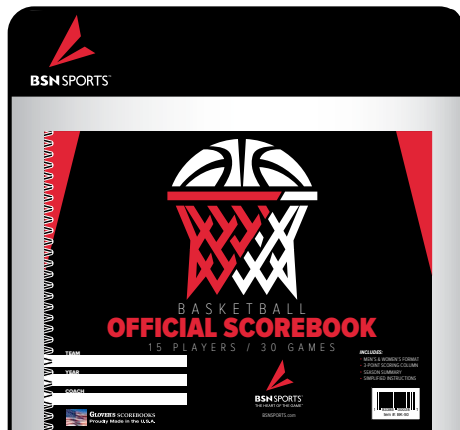

## BASKETBALL SCOREBOOK

- Includes 30 games, 15 player spots, 3-point scoring, team roster, season schedule, season summary, and simplified scoring instructions
- 8 1/2" x 11" spiral bound with soft cover

**MSBSKBOK** \$13<sup>99</sup> EA

## DRY ERASE BOARD

- Large, portable 24"H x 30"W board
- Use to keep score, as a sign, to explain an activity and more
- Features a cut-out handle for carrying

**1363637** \$59<sup>99</sup> EA ★

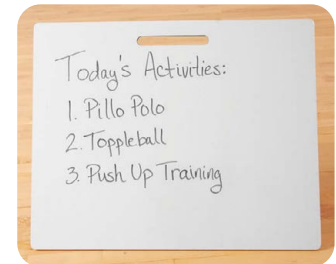

## DRY ERASE BOARDS

- Large format enables entire team to see play
- 2 writing surfaces
- Great pen clip with premium dry erase marker
- 1/2 court featured on back
- 12 1/2"H x 16 1/2"W - 2 lbs.

**1405765** 12 1/2"H x 16 1/2"W - 2 lbs. \$36<sup>99</sup> EA



## PORTABLE PLAYMAKER BASKETBALL BOARD

- 18" x 24" durable dry erase board with handle
- Full-court diagram on one side, the other side is a blank, dry erase surface that can be used to flash plays or other information from the sideline
- Includes dry erase pen that attaches to the board

**1299786** \$69<sup>99</sup> EA

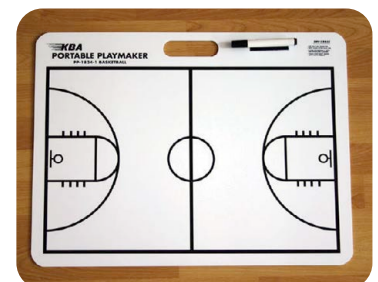

## BASKETBALL COACH'S BOARD

- Front half court and back full court writing surfaces
- Includes premium dry erase marker
- 8"W x 15 1/2"L

**1388107** \$27<sup>99</sup> EA ★

## COURT EQUIPMENT

### SLIPP-NOTT TRACTION SYSTEM-LARGE

- Used by professional, college, and high school basketball teams to remove dust, dirt and wax build-up from shoe soles with one quick action
- Simply walking on it improves the traction and maneuverability
- Large set: 28" x 29" base and (75) 26" x 26" sheets



<b>1298697</b>	Large Base & Pad Set	<b>\$344<sup>99</sup></b> EA
<b>1298703</b>	Repl. Pad (75 sheets) for Large Set	<b>\$139<sup>99</sup></b> EA

### SLIPP-NOTT TRACTION SYSTEM-SMALL

- Used to remove dust, dirt and wax build-up from shoe soles
- Simply walking on it improves traction and maneuverability
- Typical game usage is 2-6 sheets
- 18" x 19" base and (75) 15" x 18" sheets

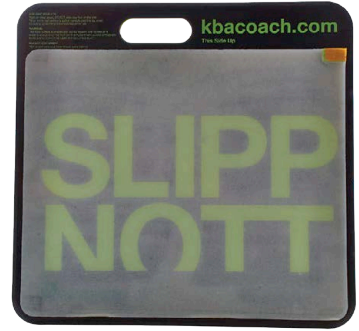

<b>1298673</b>	Small Base & Pad Set	<b>\$199<sup>99</sup></b> EA
<b>1298680</b>	Repl. Pad (75 sheets) for Small Set	<b>\$89<sup>99</sup></b> EA

### COURTCLEAN START-UP/TUNE-UP KIT

- Keeps your floors clean and shiny
- Includes 5 gallon bucket, 4 towels and 1 gallon of Shine-All cleaner

<b>1237566</b>	Kit w/8' Towels	<b>\$299<sup>99</sup></b> EA
<b>1292015</b>	Kit w/6' Towels	<b>\$279<sup>99</sup></b> EA
<b>1237573</b>	1gal. Super Shine	<b>\$69<sup>99</sup></b> EA

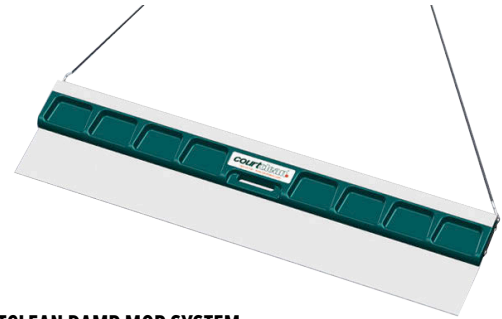

### COURTCLEAN DAMP MOP SYSTEM

- Clean court in minutes
- Improves floor conditions and protects floor finish
- Includes custom sweeper pad, specially designed towel and pull rope
- Works on any hard floor surface

<b>1271058</b>	6' Unit	<b>\$729<sup>99</sup></b> EA
<b>1271065</b>	6' Replacement Towel	<b>\$54<sup>99</sup></b> EA
<b>1079709</b>	8' Replacement Towel	<b>\$69<sup>99</sup></b> EA

**NEW!**

### H2O PERFORMANCE PACK

- Performance Pack includes 5 markers: red, orange, green, blue, and purple
- One canister of foot wipes
- One bag of R&R foot towels (20 towels)



<b>1461860</b>		<b>\$84<sup>99</sup></b> PACK
----------------	--	-------------------------------

### FLOORMARX™ SET

- Safe, smart, and easy way to instruct movement
- Quick to apply and easy to remove
- Fast drying ink (2min) and cleaning wipes (30 sec) pass safety slip tests
- One Floor Marker writes for over 250 yards (over 4 rolls of traditional floor tape)
- Set includes 2 Floor markers, 1 green and 1 blue, and 1 canister cleaning foot wipes
- Intended for sealed gymnasiums and dance floors, and other non-porous surfaces
- BEFORE FULL APPLICATION, always test on multiple, small, inconspicuous areas of the floor



<b>1454864</b>		<b>\$45<sup>99</sup></b> SET
----------------	--	------------------------------

### FLOOR MARKING TAPE

- Use on any smooth floor surface
- Color Options: **Black, Blue, Green, Gold, Orange, Purple, Red, White.**

<b>FTAP16</b>	1" x 60 Yd.	<b>\$10<sup>99</sup></b> EA ★
<b>FTAP26</b>	2" x 60 Yd.	<b>\$12<sup>99</sup></b> EA ★



### KEYCLEAN PRO

- Clean on the go...play like a pro!
- A large 18" x 24" surface offers full coverage for quick clean-up
- Highly absorbant, specially designed microfiber pads rapidly absorb sweat and moisture
- Reduces potential for slip and falls that can cause serious injury
- Custom Mops - Ships in 2 weeks to ship after art approval

<b>1383869</b>	Set of 2 Mops - Standard	<b>\$419<sup>99</sup></b> EA
<b>1399641</b>	Set of 2 Mops w/Custom Logo	<b>\$489<sup>99</sup></b> PACK
<b>1393374</b>	Microfiber Pad - Each	<b>\$56<sup>99</sup></b> EA



## STORAGE EQUIPMENT



### MONSTER BALL CART

- Fabricated from 1" square steel
- Black powder coated finish
- Holds 15 official size basketballs

**7 Year Limited Warranty**

**1162608** 30"H x 49"W x 20"D - 30 lbs. **\$349<sup>99</sup>** EA ★



**NEW!**

### TF 6-BALL BAG

- Internal compartments for 6 basketballs
- Adjustable and removable shoulder strap
- Open air side vents allow for moisture escape
- High grade durable construction

**1459596** **\$44<sup>99</sup>** EA



### DOUBLE MONSTER BALL CART

- Fabricated from 1" square steel
- Black powder coated finish
- Holds 30 official size basketballs

**7 Year Limited Warranty**

**1162615** 30"H x 49"W x 24"D - 54 lbs. **\$549<sup>99</sup>** EA ★



**3-ROW  
12 BALLS**



### 15 BALL CART

- Heavy duty chrome steel rods
- Solid triangular frames for strength and stability
- Non-marring casters
- Wide base design prevents tip over
- Holds 15 official size basketballs

**1159639** 38"H x 51"W x 19"D - 10 lbs. **\$159<sup>99</sup>** EA ★



### SUPER TUFF BALL CART WITH MASCOT

- Powder coated steel welded construction
- 3" non marring, swivel caster wheels
- Holds 15 official size basketballs
- Includes one-color school name or mascot
- Frame Colors: Royal, Red, Gray, White, Black, Athletic Gold, Orange, Forest Green, Kelly Green, Maroon, Navy, Columbia, Cardinal, Purple, Texas Orange

**7 Year Limited Warranty**

**1366519** Size - 51"L x 20"W x 29"H **\$589<sup>99</sup>** EA



**4-ROW  
16 BALLS**



### HEAVY-DUTY BALL CARTS

- Welded 1" square wall tubing with 3/4" steel chrome plated, ball support arms
- Non-marring, high quality 360° swivel casters
- Extra wide wheel base avoids tipping
- Add a school or mascot name, up to (10) letters, to the end panels (lettering sold separately and is not applied by manufacturer)

**5 Year Limited Warranty**

Color Options: **Grey, Royal Blue, Scarlet, White.**

**1048452** 12 Ball Cart **\$546<sup>99</sup>** EA  
**1048490** 18 Ball Cart **\$606<sup>99</sup>** EA  
**1245899** Lettering **\$116<sup>99</sup>** EA

### WIDE BODY BALL CARTS

- Heavy duty white powder coated steel tubing
- Non-marring, hard rubber casters with a wide, no-topple base
- Designed for easy storage and removal of balls
- 12 Ball Cart - 40"W x 40"H x 16"D
- 16 Ball Cart - 40"W x 52"H x 16"D

**BCART12W** 3 Row, 12 Balls **\$104<sup>99</sup>** EA ★  
**BCART16W** 4 Row, 16 Balls **\$119<sup>99</sup>** EA ★



### DOUBLE-WIDE BALL CART

- Made of 1" rugged chrome steel
- Holds 30 full size basketballs
- Comes with heavy duty swiveled rubber casters

**1237634** 33"H x 45"W x 24"D - 35 lbs. **\$394<sup>99</sup>** EA ★

## STORAGE EQUIPMENT



### MONSTER BALL LOCKER

- Constructed of 1" powder coated steel tubing
- Holds 30 official basketballs or 40 volleyballs
- Features over sized 4" wheels for easy movement
- The top is lockable (lock not included) and contains special hinges and safety chains to prevent top from falling over

**1162622** 37"H x 47"W x 24"D - 75 lbs. **\$669<sup>99</sup>** EA ★



### STANDARD PORTABLE BALL LOCKER

- 1" steel tubing frame
- Holds up to 20 basketballs
- Hinged cover can be locked (lock not included)

**12002100** 43"H x 41"W x 24"D - 35 lbs. **\$429<sup>99</sup>** EA ★



### WALL MOUNTED BALL LOCKERS

- Constructed of 1" black powder coated steel tubing
- Permanently mounts to your gym wall (hardware not included)
- Holds 6 basketballs; Double model holds 16 basketballs or 30 volleyballs
- Double model includes locking bars at the top and bottom to secure balls (locks sold separately)

**1173123** 66"H x 15"W x 12"D **\$303<sup>99</sup>** EA ★

**1162578** 66"H x 37"W x 12"D **\$352<sup>99</sup>** EA ★



### 50 BALL CART

- Constructed of 1" O.D. black powder coated steel tubing
- Heavy duty urethane swivel wheels - 2 with brakes
- 5 welded shelves make for easy assembly
- Will hold 50 official size basketballs
- Fits through standard doorways

**1378673** 64"H x 24"W x 61"L - 61 lbs. **\$499<sup>99</sup>** EA ★



### MESH BALL CARRIER

- Comes with shoulder strap, vinyl bottom and mesh top fabric

**1235654** 22"H x 28"W **\$45<sup>99</sup>** EA ★



### NET BALL CARRIER

- Holds 8-12 volleyballs, soccer balls, basketballs, or footballs

**SNBC1XXX** White Only **\$10<sup>99</sup>** EA ★



### MESH DUFFEL BAG

- Open mesh keeps towels and clothing fresh and dry
- Features a full length zipper, handles and shoulder strap
- Color Options: Green, Gold, Orange, Purple, Royal, Scarlet.

**4095** 15"H x 36"L **\$28<sup>99</sup>** EA ★



A



B



C

## SPALDING

### A ADVANCE PRO COMPOSITE SERIES

- Premium composite cover
- Laminated cover design
- Soft grip TPR lace

<b>WC726548</b>	Official Size	\$29 <sup>99</sup> EA
<b>WC726858</b>	Youth, 12-14	\$28 <sup>99</sup> EA
<b>WC726868</b>	Junior, 9-12	\$28 <sup>99</sup> EA
<b>WC726848</b>	Pee Wee, 6-9	\$26 <sup>99</sup> EA

## Wilson

### B GST COMPOSITE SERIES

- Premium pebble composite leather construction with ACL lacing system
- Official size is NFHS approved

<b>1297287</b>	Official Size	\$45 <sup>99</sup> EA
<b>1297294</b>	Youth, 12-14	\$45 <sup>99</sup> EA
<b>1297300</b>	Junior, 9-12	\$45 <sup>99</sup> EA
<b>1297317</b>	Pee Wee, 6-9	\$45 <sup>99</sup> EA

## MacGregor

### C MC COMPOSITE SERIES

- Tackified composite cover
- Double leather laced and nylon wound carcass

<b>1227697</b>	Official Size	\$24 <sup>99</sup> EA ★
<b>1227680</b>	Youth, 12-14	\$22 <sup>99</sup> EA ★
<b>1227673</b>	Junior, 9-12	\$22 <sup>99</sup> EA ★
<b>1227666</b>	Pee Wee, 6-9	\$22 <sup>99</sup> EA ★

**NEW!**



### ALL FIELD 4.0 COMPOSITE SERIES

- Engineered shape for tighter spirals and a better fit in your hand
- High-Grade composite leather for more tack and an easier catch
- Textured laces help improve your grip in all conditions
- Valve is placed to help minimize distraction
- Contents: 80% Rubber, 17% Synthetic Leather, 3% Polyester

Size: Junior, Pee Wee, Official, Youth.

**NKN1004469** Select Size \$35<sup>00</sup> EA



**NEW!**



### TOURNAMENT 4.0 COMPOSITE SERIES

- Engineered shape for tighter spirals and a better fit in your hand
- High-Grade composite leather helps increase durability
- Two Sewn-In, Bordered stripes give you extra grip points
- Textured laces help improve your grip in all conditions
- Valve is placed to help minimize distraction
- Contents: 80% Rubber, 17% Synthetic Leather, 3% Polyester

Size: Junior, Pee Wee, Official, Youth.

**NKN1007497** Select Size \$45<sup>00</sup> EA



### MacGregor RUBBER FOOTBALL

- Pebble grained exterior
- Raised molded laces and simulated seams
- All weather, all surface play

<b>MCX2LXXX</b>	Official Size	\$15 <sup>99</sup> EA ★
<b>MCX2YXXX</b>	Youth, 12-14	\$14 <sup>99</sup> EA ★
<b>MCX2JXXX</b>	Junior, 9-12	\$13 <sup>99</sup> EA ★

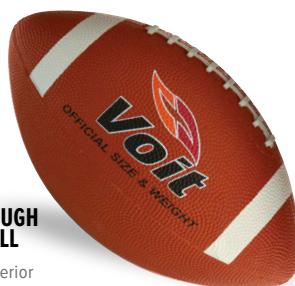

### Voit PLAYGROUND TOUGH RUBBER FOOTBALL

- Pebble grained exterior
- Raised molded laces and simulated seams
- All weather, all surface play
- 2 Year Limited Warranty

<b>VCF9SHXX</b>	Official Size	\$16 <sup>99</sup> EA ★
<b>VCF7SHXX</b>	Youth, 12-14	\$15 <sup>99</sup> EA ★
<b>VCF6SHXX</b>	Junior, 9-12	\$13 <sup>99</sup> EA ★
<b>VCF5SHXX</b>	Pee Wee, 6-9	\$13 <sup>99</sup> EA ★

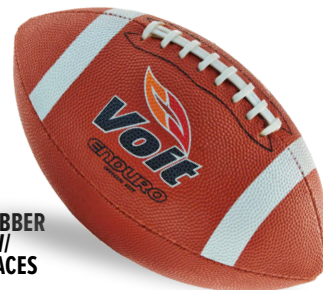

### Voit ENDURO RUBBER FOOTBALL W/ STITCHED LACES

- Pebble grained sewn rubber panels
- Composite stitched laces
- Butyl bladder for better shape and air retention
- Plays and feels better than a molded rubber ball

<b>1376978</b>	Official Size	\$22 <sup>99</sup> EA ★
<b>1376979</b>	Youth Size, 12-14	\$22 <sup>99</sup> EA ★
<b>1376980</b>	Junior, 9-12	\$20 <sup>99</sup> EA ★

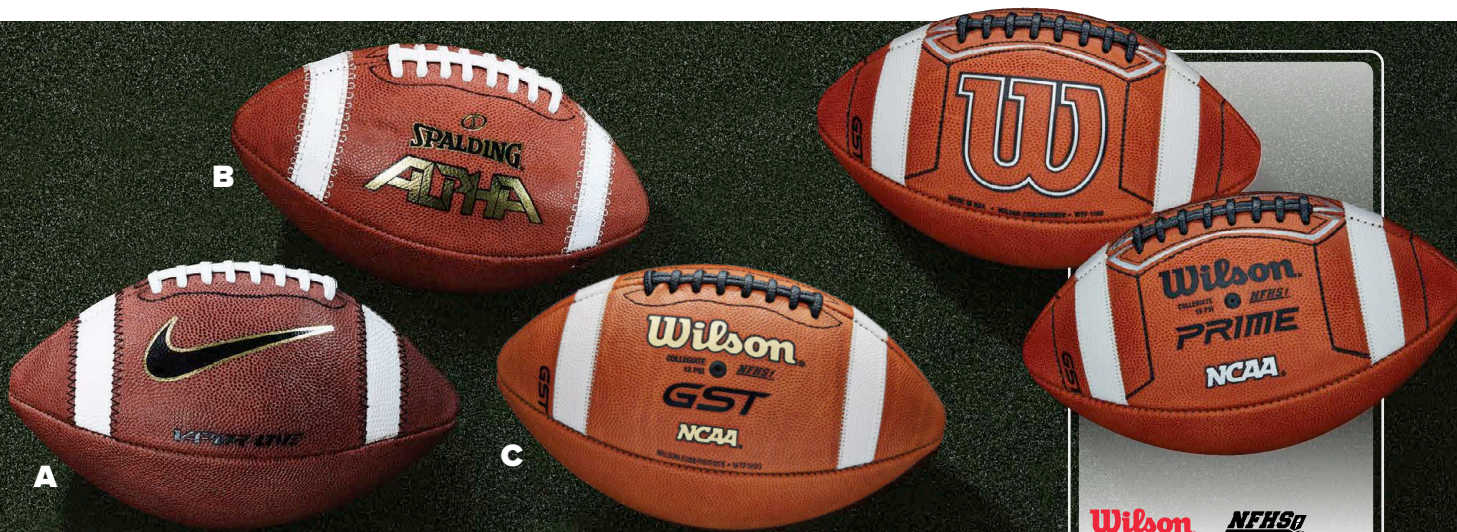

**A VAPOR ONE 2.0 SERIES**

- Custom crafted premium tacky leather
- Innovative stitched-in TEXTURED half-stripe
- Official size is NFHS approved

<b>1454495</b>	Official Size	\$100 <sup>00</sup> EA
<b>1454496</b>	Youth, 12-14	\$90 <sup>00</sup> EA
<b>1454497</b>	Junior, 9-12	\$80 <sup>00</sup> EA

**B ALPHA**

- Horween® "S" tack leather cover with two-ply TPU bladder
- Boxed sewn strip and raised diamond lace
- Official size is NFHS approved

<b>WC726758</b>	Official Size	\$109 <sup>99</sup> EA
<b>WC726748</b>	Youth, 12-14	\$64 <sup>99</sup> EA

**C GST LEATHER SERIES**

- 863 WE leather construction with tanned-in tack
- Exclusive sewn in grip stripes with ACL Lacing
- Official size is NFHS approved

<b>3F1003</b>	Official Size	\$109 <sup>99</sup> EA
<b>1167931</b>	Youth, 12-14	\$79 <sup>99</sup> EA
<b>1167939</b>	Junior, 9-12	\$79 <sup>99</sup> EA

**Wilson GST PRIME GAME FOOTBALL NCAA/HS**

- Extra grip-point stitching for more accurate passing
- Sewn-on stripe & composite pebbled laces for additional control
- Prep gauge signifies when ball is fully broken-in for game play

<b>WLWTF11031B</b>	Official Size	\$149 <sup>99</sup> EA
--------------------	---------------	------------------------

**Wilson**

**GST PRIME BLEM FOOTBALL**

- Minor cosmetics blemishes or random stamped logos
- Ideal for Practices and Walkthroughs
- **Not permitted for use in Games**

<b>WLWTF11031BS</b>	Official Size - GST Prime Blem	\$139 <sup>99</sup> EA
<b>1405105</b>	Official Size - GST Blem	\$99 <sup>99</sup> EA

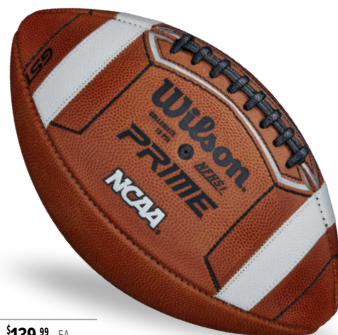

**NFHS APPROVED**

**SPALDING**

**J5V ADVANCE**

- Top grade Horween® leather
- SBR Foam backing and rubberized laces
- 4-ply water resistant liner and TPU bladder

<b>WC628999</b>	Official Size	\$95 <sup>00</sup> EA
-----------------	---------------	-----------------------



**AUTOGRAPH FOOTBALL**

- Synthetic leather (PVC) cover
- For display purposes ONLY
- 3 white panels for autographs

<b>1072518</b>	Official Size	\$24 <sup>99</sup> EA *
----------------	---------------	-------------------------

**SPALDING**

**SIGNATURE SERIES AUTOGRAPH FOOTBALL**

- Composite cover
- Machine stitched
- Butyl rubber bladder
- 3 white panels for autographs

<b>WC726338</b>	Official Size	\$25 <sup>99</sup> EA
-----------------	---------------	-----------------------



**Mikasa SPORTS**

**RUGBY BALL**

- Stitched match ball
- Rubber four fold polyester cover
- Butyl bladder for maximum air retention
- Official Size

**2 Year Limited Warranty**

<b>1303674</b>	Official Size	\$35 <sup>99</sup> EA
----------------	---------------	-----------------------



## PRO-DOWN

CARRY BAG SOLD SEPARATELY.

### VARSITY KICKING CAGE

- Heavy-duty 1 1/2" round 17-gauge galvanized steel frame
- Optic yellow sides help kickers visualize goal post
- Assembles and disassembles easily for travel and storage
- 82"H x 41"W x 41"D - 27 lbs.
- Carry bag sold separately

<b>1052480</b>	Complete Unit	\$224 <sup>99</sup> EA ★
<b>1052473</b>	Replacement Net Only	\$60 <sup>99</sup> EA ★
<b>1363685</b>	Carry Bag	\$89 <sup>99</sup> EA ★

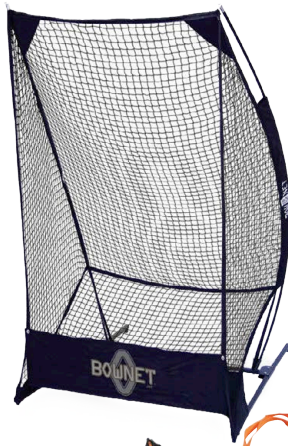

## BOW NET

CARRY BAG INCLUDED!

### SOLO KICKER

- Unique design makes it the most portable practice Kicker net ever
- Powder coated steel ground frame, and composite Bow Poles
- No tools needed and sets up easily in 90 seconds.
- 74"H x 4"W x 5'6"D - 23 lbs.
- Includes carry bag

<b>1367618</b>	Complete Unit	\$549 <sup>99</sup> EA
----------------	---------------	------------------------



## PRO-DOWN

### PASS AND SNAP TRAINER

- Steel powder coated base and anodized aluminum upper frame
- 4'H x 4'W pocket with movable target
- Adjust pocket from 30 to 90 degrees
- 6" heavy-duty casters

<b>FBQBTXX</b>	96"H x 51"W x 48"D	\$949 <sup>99</sup> EA ★	<b>S&amp;H</b>
<b>FBQBTN</b>	Replacement Net	\$120 <sup>99</sup> EA ★	



### SOCCER STYLE KICKING TEE

- Unique design allows soccer style kickers to make contact with the ball first, instead of the tee
- Weighted for stability

<b>MSSKTRFX</b>	Right Footed Kicker	\$6 <sup>99</sup> EA ★
<b>MSSKTLFX</b>	Left Footed Kicker	\$6 <sup>99</sup> EA ★



### PLACEKICK TEE

- Heavyweight black rubber tee
- Serrated bottom for holds on grass or turf

<b>1405565</b>	1 in.	\$5 <sup>99</sup> EA
<b>MSPATXXX</b>	2 in.	\$6 <sup>99</sup> EA ★



## GROUND ZERO

### GROUND ZERO KICKING TEE

- Heavy duty black rubber tee
- 1" includes on-side kick feature; 2" does not
- Used by NFL Super Bowl teams

<b>FBGZ1</b>	1"	\$26 <sup>99</sup> EA ★
<b>1405590</b>	2"	\$27 <sup>99</sup> EA



### WIZARD KICKING STIX<sup>®</sup> FOOTBALL HOLDER

- Durable powder coated steel and aluminum construction
- Riveted legs for easy, quick fold-up design
- Works with or without place kick tee
- Football sold separately

<b>1363687</b>		\$37 <sup>99</sup> EA
----------------	--	-----------------------



## Sport Write!

### PRO FOOTBALL DRY-ERASE BOARDS

- Large format enables entire team to see play
- 2 writing surfaces
- Includes pen clip with dry erase marker

<b>1405760</b>	12.5"H x 16.5"W - 2lbs.	\$33 <sup>99</sup> EA
----------------	-------------------------	-----------------------



## Wilson

### GAME BALL PREP KIT

- Conditions leather for maximum tack and extended use of game balls
- Wax bar lasts longer for frequent use
- Durable brush withstands rough application and buffing

<b>1375489</b>		\$30 <sup>99</sup> EA
----------------	--	-----------------------

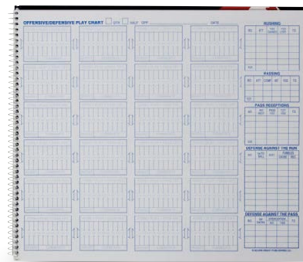

### FOOTBALL STAT BOOK

- Simplified instructions for charting offensive and defensive plays
- 11 game stat book with 24 play charts per quarter

<b>1197631</b>		\$24 <sup>99</sup> EA
----------------	--	-----------------------



### KICKOFF TEE

- Universal style rubber kicking tee

<b>1405560</b>	1 in.	\$5 <sup>99</sup> EA
<b>MSKICKOF</b>	2 in.	\$5 <sup>99</sup> EA ★



## Wilson

### PRO KICK

- Collapsible sturdy all-metal construction
- Holds any size football to the desired angle
- Works with or without kicking tee
- Football sold separately

<b>1008579</b>		\$35 <sup>99</sup> EA
----------------	--	-----------------------



**FIXED RUNG AGILITY LADDER**

- Ideal for developing quick and accurate foot speed, increased balance and coordination
- Each ladder is 15'L x 20"W with ten sections
- Rugged 1" wide webbing with end buckles allow various shape configurations for a more diversified workout
- Connecting buckles allow for additional ladders for longer runs and different formations
- Includes carry bag

1271560

\$53<sup>99</sup> EA ★



**COLLEGIATE LINEMAN CHUTE**



- Double overhead bars keep players low at snap and allows them to rise after first few steps of drive
- Sturdy build 2" Galvanized Steel tubing
- Designed to slide easily across fields with no damage to turf
- Entrance height is 45" and exit height is 52"
- Assembled dimensions – 48"W x 60"L
- 1 man base unit required and then add on as many sections as needed
- Weighs 68.5 lbs.

1272987  
1272994

Base Unit  
Add-a-Chute

\$449<sup>99</sup> EA ★   
\$339<sup>99</sup> EA ★

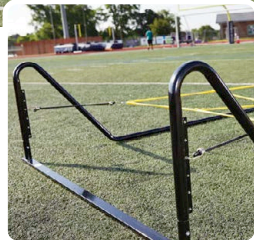

**RUNNING ROPES**

- Frame constructed of powder-coated 17-gauge steel tubing
- Exclusive frame design keeps all tubing safely away from the training path
- Optic yellow nylon step grid is 14' 10"L x 3' 3"W
- Frame dimensions: 18' 6"L x 4' 6"W, grid adjusts from 6" to 15" H
- Step grid connects to frame with bungee cords

1201987 Complete Unit \$359<sup>99</sup> EA ★  
1201994 Replacement Running Grid \$109<sup>99</sup> EA ★



**VARSITY LINEMAN CHUTE**

- Heavy-walled 1 5/8" powder coated steel tubing
- Entrance height is fixed at 40" and exit height is fixed at 48"
- Assembled dimensions: 50"L x 50"W
- Includes hardware to link multiple chutes together

FBVCHUTE

\$219<sup>99</sup> EA ★



**ADJUSTABLE LINEMEN SPLIT MARKER**

- Heavy-duty vinyl construction w/ weights at the ends & center keeping it flat on the ground
- The labeled removable positions attaching a hook-&-loop fastening strip to customize formations
- 39"L overall, 10.5"W black strip with 36"L yellow position indicators labeled with 9"H letters
- Great for teaching linemen and backs splits and gaps

200234007 \$199<sup>99</sup> EA ★

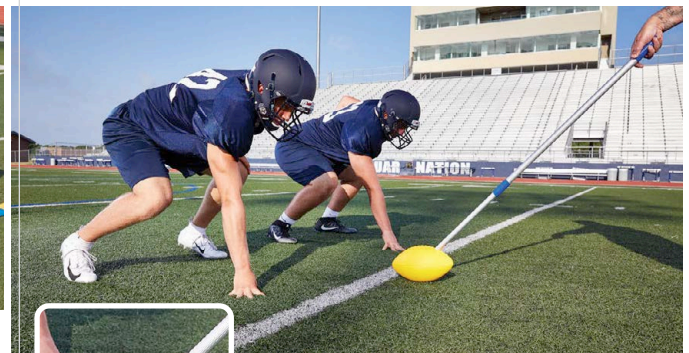

**SNAPPER STICK**

- Aluminum pole with foam rubber football
- Teach players to react to ball movement not cadence
- Telescoping aluminum pole extends from 30" to 60"
- Allows coach to stand instead of kneeling

1299939

\$67<sup>99</sup> EA ★



# PRO DOWN

- Double-reinforced 18 oz. vinyl shell
- Durable foam interior

- Black ProDown in stock\*
- Other colors ship from Fisher Athletic with Fisher logo. Allow 2-3 Weeks for delivery



### COLLEGIATE SHIELD

- 2 reinforced handles
- 16"W x 26"L - 4 lbs.

**200232812** Black Only - 6"H **\$94<sup>99</sup>** EA ★  
**1393022** Specify Color - 4"H **\$104<sup>99</sup>** EA



### MAN SHIELD

- 22"W x 26"L x 5"H - 5 lbs.; 4 reinforced handles

**1384302** Royal **\$139<sup>99</sup>** EA ★  
**1384303** Black **\$139<sup>99</sup>** EA ★



### PRO SHIELD

- 2 reinforced handles
- 16"W x 42"L x 4"H - 5 lbs.

**200234412** Black Only **\$91<sup>99</sup>** EA ★



### FOREARM SHIVER PADS

- 24" x 11.5" x 3"
- Shock foam pad with nylon-reinforced cover
- Protects hand and forearm area

**200232412** Black Only **\$38<sup>99</sup>** EA ★



### MULTI-PURPOSE EQUIPMENT WAGON

- All steel construction with pneumatic tires
- Use for carrying equipment, water containers, or field storage
- Front, rear, and side panels fold away for easy loading/unloading
- 1400 lb. weight capacity

**1291766** 11"H (sides) x 24"W x 48"L **\$499<sup>99</sup>** EA ★  
**1334647** Optional Hook Set **\$24<sup>99</sup>** SET



### FOOTBALL FIELD EQUIPMENT CART

- Heavy duty cart designed to easily transport football sideline equipment
- J-Hooks and strap to carry down marker and chain set
- Steel frame with sturdy expanded metal deck to prevent standing water
- Sized right to carry pylons, sideline markers and goal post pads
- Maneuvers easily with semi-pneumatic casters and pull handle
- Equipped with optional use towing attachment

**1378681** 47"L x 33"W x 37"H - 120 lbs. **\$749<sup>99</sup>** EA ★

SHIELD DUMMY COLOR CHOICES: CHOOSE FROM 11 SCHOOL COLORS

COLORS OTHER THAN BLACK SHIP FROM FISHER ATHLETIC WITH FISHER LOGO.

**BLACK\***

**DARK GREEN**

**GRAY**

**KELLY**

**MAROON**

**NAVY**



- Double-reinforced 18 oz. vinyl shell
- Durable foam interior

- Black ProDown in stock
- Other colors ship from Fisher Athletic with Fisher logo. Allow 2-3 Weeks for delivery



### ROUND BLOCKING DUMMY

- 2 reinforced handles

200235312  
1393055

13"W x 38"L - 10 lbs. - Black Only  
13"W x 38"L - 10 lbs. - Specify Color

\$219<sup>99</sup> EA ★  
\$224<sup>99</sup> EA



### HEAVY ROUND BLOCKING DUMMY

- 2 reinforced handles

200235112  
1393267

14"W x 48"L - 20 lbs. - Black Only  
14"W x 48"L - 20 lbs. - Specify Color

\$244<sup>99</sup> EA ★  
\$249<sup>99</sup> EA



### STEP-OVER DUMMIES

- Handles on ends and bottom

200230812  
1393279  
200231212  
1393290

17"B x 8"H x 51"L - 10 lbs. - Black Only  
17"B x 8"H x 48"L - 20 lbs. - Specify Color  
17"B x 12"H x 51"L - 20 lbs. - Black Only  
17"B x 12"H x 48"L - 30 lbs. - Specify Color

\$169<sup>99</sup> EA ★  
\$219<sup>99</sup> EA  
\$249<sup>99</sup> EA ★  
\$264<sup>99</sup> EA



### SQUARE BLOCKING DUMMY

- 2 reinforced handles

200235012  
1393044

14"W x 50"L - 15 lbs. - Black Only  
14"W x 50"L - 14 lbs. - Specify Color

\$239<sup>99</sup> EA ★  
\$259<sup>99</sup> EA



### REPLACEMENT DUMMIES FOR OUTDOOR SLEDS

- Polyurethane foam filling covered with durable 18 oz. vinyl
- Seams are double stitched with heavy-duty nylon thread for added durability
- Cone pad only includes handles to allow for dummy use without sled
- Cone and Man pad in stock in Royal Blue only
- Cone pad dimensions: 48"H x 18" Top Diam x 13" Bottom Diam
- Man Pad dimensions: 48"H x 28"W x 10"D

1296259

Pro Pad - Royal Only

\$649<sup>99</sup> EA ★

DUE TO DYE LOTS AND NATURAL VARIATIONS, VINYL COLORS MAY VARY SLIGHTLY IF ORDERED AT SEPARATE TIMES.

ORANGE

PURPLE

RED

ROYAL

GOLD

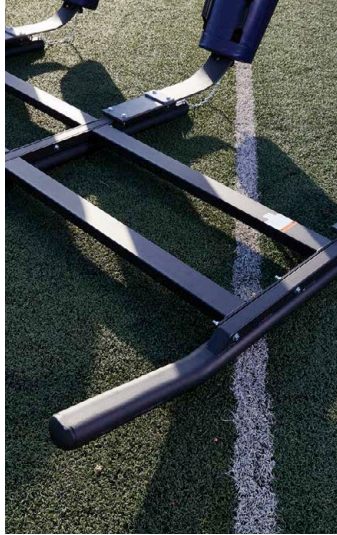

**VARSITY M-SERIES BLOCKING SLEDS**

- All steel powder coated frame construction
- Modular frame construction allows for convenient expansion or removal of a man when needed
- Features 52" splits
- Super-Duty flat leaf springs absorb initial shock and recoils with equal force
- Round tubular steel "all surface" skids
- Optional Coaches Platform available
- Comes stock with royal blue

**5 Year Limited Warranty**

<b>1378632</b>	2-Man with Royal Pro Pads	\$2,299 <sup>99</sup> EA ★ <b>S&amp;H</b>
<b>1378633</b>	3-Man with Royal Pro Pads	\$3,499 <sup>99</sup> EA ★ <b>S&amp;H</b>
<b>1378634</b>	4-Man with Royal Pro Pads	\$4,699 <sup>99</sup> EA ★ <b>S&amp;H</b>
<b>1378635</b>	5-Man with Royal Pro Pads	\$5,899 <sup>99</sup> EA ★ <b>S&amp;H</b>
<b>1378636</b>	6-Man with Royal Pro Pads	\$6,899 <sup>99</sup> EA ★ <b>S&amp;H</b>
<b>1378637</b>	7-Man with Royal Pro Pads	\$7,899 <sup>99</sup> EA ★ <b>S&amp;H</b>
<b>1362618</b>	Optional Coaches Platform	\$279 <sup>99</sup> EA ★ <b>S&amp;H</b>



**M-SERIES 1-MAN SLED**

- All steel powder coated frame construction
- Super-duty flat leaf springs absorb shock and bounce back providing maximum recoil
- Tubular steel skids for durability and performance on all field types
- Stock pads available in cone or pro pad design in royal blue

**1271522** Royal Pro Pad - 230 lbs. \$1,299<sup>99</sup> EA ★ **S&H**



**YOUTH BLOCKING SLEDS**

- All steel powder coated "modular frame construction" allows you to add or remove a man from the sled as desired
- Super-Duty flat leaf springs absorb initial shock and returns it with equal force
- Powder coated tubular steel skids can be used on all field surfaces
- These sleds are ideal for the 11 to 15 year old age group
- Features 42" splits

**5 Year Limited Warranty**

<b>1362612</b>	2 Man with Royal Pro Pads - 265 lbs.	\$1,899 <sup>99</sup> EA ★ <b>S&amp;H</b>
<b>1362613</b>	3 Man with Royal Pro Pads - 405 lbs.	\$2,599 <sup>99</sup> EA ★ <b>S&amp;H</b>
<b>1362615</b>	5 Man with Royal Pro Pads - 690 lbs.	\$3,999 <sup>99</sup> EA ★ <b>S&amp;H</b>
<b>1362617</b>	7 Man with Royal Pro Pads - 970 lbs.	\$5,399 <sup>99</sup> EA ★ <b>S&amp;H</b>
<b>1362618</b>	Optional Coaches Platform	\$279 <sup>99</sup> EA ★ <b>S&amp;H</b>

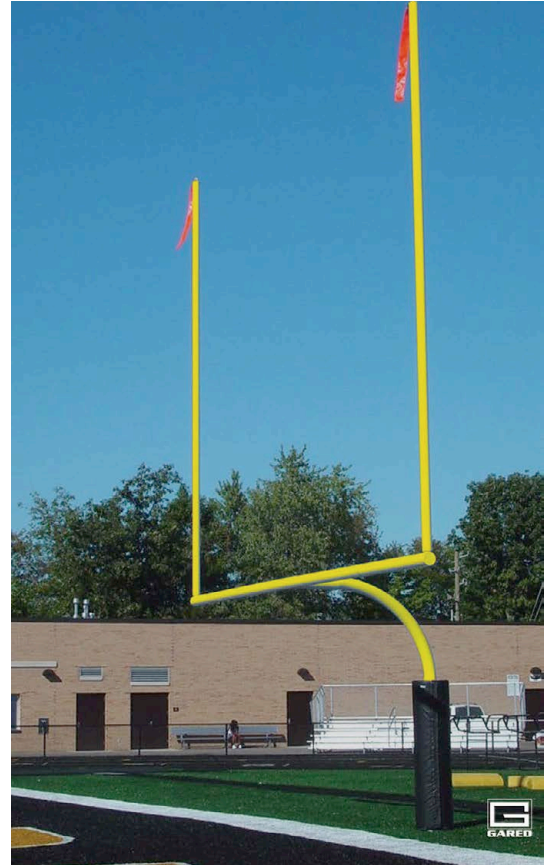

### GOOSENECK FOOTBALL GOAL POSTS

- Newly re-designed with enhanced features for easier assembly and installation (some drilling in the field is required)
- Meets NFSHSA specifications with 23' 4" Crossbar
- 4-1/2" O.D. main gooseneck with 5' offset with 4-1/2" O.D. Crossbar
- 2-3/8" O.D. uprights with choice of 20' or 30' height
- Two-piece 30' uprights (20' and 10')
- Permanent installation or Optional Ground Sleeves available for semi-permanent installation
- Sold in Pairs

**5 Year Limited Warranty**

#### High School Crossbar 23'4"

<b>1399646</b>	Yellow - 20' Upright	\$5,249 <sup>99</sup> PR ★	
<b>1399649</b>	Yellow - 30' Uprights	\$5,999 <sup>99</sup> PR ★	
<b>1399644</b>	White - 20' Uprights	\$5,249 <sup>99</sup> PR ★	
<b>1399647</b>	White - 30' Upright	\$5,999 <sup>99</sup> PR ★	
<b>1399656</b>	Optional Ground Sleeves	\$1,029 <sup>99</sup> PR ★	
<b>1197747DS</b>	Wind Direction Flags (4/Set)	\$18 <sup>99</sup> SET	

### PROTECTIVE POST PADS

- 6'H post pad constructed of 4" thick high-density urethane foam encased in 18 oz. vinyl
- Available in two sizes with hook-and-loop closure design
- Please specify color. Red and Royal Blue in stock.

<b>1362696</b>	Hook & Loop up to 4 1/2" O.D. Post	\$419 <sup>99</sup> EA ★
<b>1366530</b>	Hook & Loop 4 1/2" - 5 1/2" O.D. Post	\$439 <sup>99</sup> EA ★



### PROTECTIVE POST PADS - CUSTOM

- 6'H post pad constructed of 4" thick high-density urethane foam encased in 18 oz. vinyl
- Available in two sizes with hook-and-loop closure design
- Customization available for an additional charge
- Allow 4 - 6 weeks for delivery

<b>G808YV4XDS</b>	4-1/2" O.D. Post	\$524 <sup>99</sup> EA	
<b>G808YV6XDS</b>	5 1/2" O.D. Post	\$579 <sup>99</sup> EA	

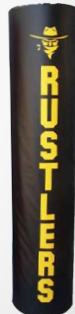

### OPTIONAL LETTERING FOR CUSTOM POST PADS

- Add up to (8) 8" letters to your post pads
- Letters will be one-color or two-color block style
- Please allow 4 - 6 weeks production time

<b>G000YXXDS</b>	One-Color	\$169 <sup>99</sup> EA
------------------	-----------	------------------------

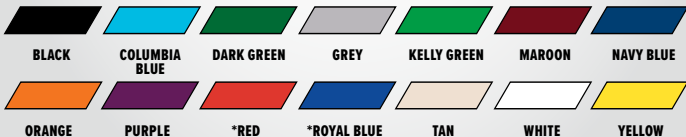

### FOOTBALL/SOCCER COMBO GOAL

- Meets High School soccer and football regulations
- 10'H football uprights are constructed of 2" square aluminum tubing
- Width of uprights can be adjusted for H.S. (23'4") or Collegiate (18'6") play or removed for soccer play
- Soccer goal size - 8'H x 24'W x 3'D
- Soccer post are constructed of 11 gauge 2" x 4" steel tubing
- Crossbars are constructed of 14 gauge 2" x 4" steel tubing
- Euro style backstays are constructed of 14 gauge - 1.5" steel tubing
- Goals include backstays, 4mm soccer nets, net fasteners and ground stakes

<b>SGFBCOM</b>	1 Pair of Goals - Includes Nets	\$4,499 <sup>99</sup> PR ★	
<b>1367769</b>	4mm - Replacement Net	\$334 <sup>99</sup> PR ★	
<b>1308082</b>	Ground Sleeves - 4/Set	\$229 <sup>99</sup> SET ★	



### SOLID SIDELINE MARKERS WITH HANDLE

- Vinyl covered foam with weighted bottom
- 15" H x 15" W with 10" H numbers
- 11 piece set includes: 2-G, 2-10, 2-20, 2-30, 2-40, 1-50
- 5 piece set includes: 2-G, 2-20, 1/40

<b>1249361</b>	11 Piece Set	<b>\$349<sup>99</sup></b> SET ★
<b>1249378</b>	5 Piece Set	<b>\$139<sup>99</sup></b> SET ★



### DAY/NIGHT SIDELINE MARKERS

- Soft, crushable foam core inside durable vinyl cover
- Improved with better visibility for day or night games
- Folding design for flat storage
- Hook and loop fasteners with weighted bottom to maintain upright position
- 15" H X 15" W with 13" H numbers
- 11 piece set includes: 2-G, 2-10, 2-20, 2-30, 2-40, 1-50

<b>1249347</b>	11 Piece Set	<b>\$429<sup>99</sup></b> SET ★
<b>1249354</b>	2-G, 2-20, 1-40	<b>\$181<sup>99</sup></b> SET ★



### STACKABLE SIDELINE MARKERS

- 13" H, 3 sided pyramid shaped markers
- Made of tough, flexible vinyl
- Stackable for easy storage
- 5-piece set includes: 2-G's, 2-20's, 1-40
- 11-piece set includes 2/G's, 2/10's, 2/20's, 2/30's, 2/40's, 1/50

<b>1245127</b>	5 Piece Set for Flag Football	<b>\$229<sup>99</sup></b> SET ★
<b>1245134</b>	11 Piece Set	<b>\$429<sup>99</sup></b> SET ★



### PYLON

- Bright, fluorescent orange
- Safe foam filled vinyl
- 18" H x 4" W x 4" D
- Set of 4

<b>MSWPYLON</b>	Weighted Anchorless	<b>\$51<sup>99</sup></b> SET OF 4 ★
-----------------	---------------------	-------------------------------------



### MOLDED FOAM PYLONS

- Solid Molded Foam construction
- Anchor weight molded into bottom
- Won't puncture or loose weight
- Bright Orange
- For use on grass or turf fields

<b>1453456</b>	Set of 6	<b>\$319<sup>99</sup></b> SET ★
----------------	----------	---------------------------------



### WEIGHTED PYLONS WITH CUSTOM PRINT

- Weighted pylons with orange vinyl cover
- 4" x 4" x 18" H
- Customize with your school mascot or other logo on all four sides
- Print in multiple colors up to 3-1/4" wide
- Allow 2 to 3 weeks for delivery after art approval

<b>1453076</b>	4/Set	<b>\$249<sup>99</sup></b> SET
<b>1453077</b>	8/Set	<b>\$369<sup>99</sup></b> SET
<b>1453078</b>	12/Set	<b>\$589<sup>99</sup></b> SET



### OFFICIALS THROW-DOWN BEAN BAG

- Weighted throw-down bean bag
- Single-sided
- Long-neck design

<b>1388016</b>	White	<b>\$8<sup>99</sup></b> EA
----------------	-------	----------------------------



### OFFICIALS CHAIN CLIP/YARD MARKER

- 14" Long - Orange Nylon
- Marks yardage from 0 - 50 in 5 yard increments
- End metal clip to fasten to chain

<b>1388017</b>		<b>\$9<sup>99</sup></b> EA
----------------	--	----------------------------



### OFFICIAL'S PENALTY FLAG

- Regulation size 15" x 15" nylon with a weighted center
- Available in yellow only

<b>FBREFFLG</b>		<b>\$10<sup>99</sup></b> EA ★
-----------------	--	-------------------------------

## BUY THE PACKAGE AND SAVE!

### DOWN INDICATORS AND CHAIN SETS

- Fully padded poles, indicator boxes, banners and bulls-eyes
- Down indicator is available in 7' 4" H padded flip style or 8' padded mechanical style with slide levers for changing down numbers
- 8' H chain sets with "Bulls-eye" design feature a two-piece pole, galvanized steel chain, swivel snap hook, molded ground stops and rubber ends.
- Fully padded banners are available in high visibility solid orange, chevron, or diagonal pattern
- J.V. chain set comes with single-ply solid orange banner



	Down Indicator Only	J.V. Chain Set & Down Indicator	Diagonal Chain Set & Down Indicator	Solid Chain Set & Down Indicator	Chevron Chain Set & Down Indicator
<b>Flip Indicator</b>	A. <b>1370767</b> \$249 <sup>99</sup> EA ★	<b>1376988</b> \$449 <sup>99</sup> SET ★	<b>FBCOLSET</b> \$474 <sup>99</sup> SET ★	<b>1379285</b> \$499 <sup>99</sup> SET ★	<b>1379286</b> \$549 <sup>99</sup> SET ★
<b>BSN SPORTS Pro-Style Indicator</b>	B. <b>FBPROBOX</b> \$499 <sup>99</sup> EA ★	<b>1379287</b> \$649 <sup>99</sup> SET ★	<b>1375486</b> \$679 <sup>99</sup> SET ★	<b>FBPROSET</b> \$724 <sup>99</sup> SET ★	<b>1375487</b> \$704 <sup>99</sup> SET ★
	<b>J.V. Chain Set Only</b>	<b>Diagonal Chain Set Only</b>	<b>Solid Chain Set Only</b>	<b>Chevron Chain Set Only</b>	
	<b>1370765</b> \$261 <sup>99</sup> SET ★	<b>FBPROCSX</b> \$265 <sup>99</sup> SET ★	<b>1370766</b> \$296 <sup>99</sup> SET ★	<b>1371543</b> \$313 <sup>99</sup> SET ★	



### PRO DOWN CHAIN SET CARRY BAG

- Will hold one complete chain set and down indicator
- Heavy-duty 600 Denier polyester construction
- Rugged nylon zipper with wrap around handles and shoulder strap
- Size: 99"L x 17.5"H x 5.25"W

**1310351** Black Only \$129<sup>99</sup> EA ★



### EDOWN DIGITAL DOWN MARKER

- 15" Super-Bright Red LED Digit
- One-Button Operation
- Lightweight – Under 9 lbs.
- Rechargeable NiMH Battery Pack (Located in Pole)
- Weatherproof Design for All Playing Conditions
- Lexan Housing is Practically Indestructible
- 8+ Hours of Operation on a Single Charge
- LED Battery Charge Indicator
- Smart Battery Charger Included (Will Not Overcharge Battery)

**1453100** 8' High \$2,099<sup>99</sup> EA



### BSN SPORTS<sup>®</sup> ELECTRONIC DOWN MARKER

- One touch control to switch between downs
- Dual brightness settings with bold 13" tall numbers
- Great for day and night games
- 7 hour rechargeable battery
- Lightweight design at 13 lbs.
- Fully padded with round corners
- Durable and water resistant
- Includes protective rain cover

**1451723** 8' High \$1,149<sup>99</sup> EA

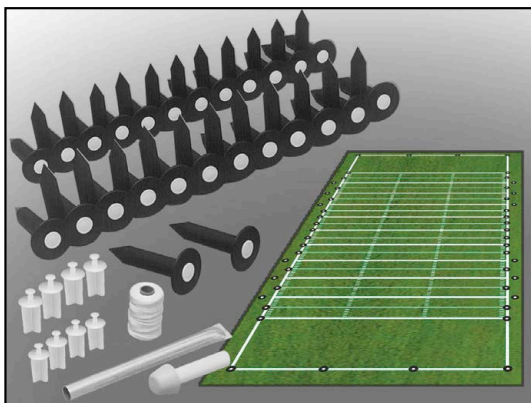

### FOOTBALL FIELD LINING SET

- Set includes 50 sockets with plugs
- Installation accessory kit
- Marks complete football field - 5 yard increments, goals and hash marks

**MKFLP50**

\$524<sup>99</sup> EA

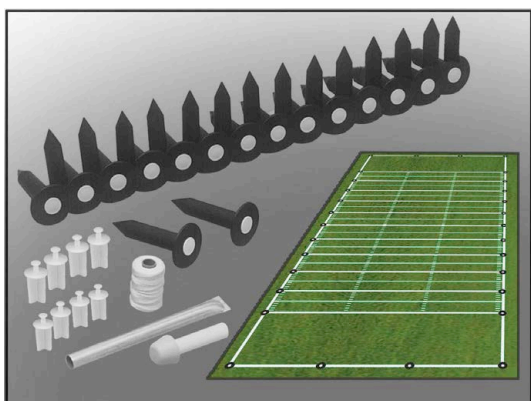

### FOOTBALL PRACTICE OR BAND LINING SET

- Set boundary lines, goal lines, every ten yard lines and hash marks
- Great for band practice fields as well
- Set includes 30 sockets with plugs
- Installation accessory kit

**MKPLP30**

\$354<sup>99</sup> EA

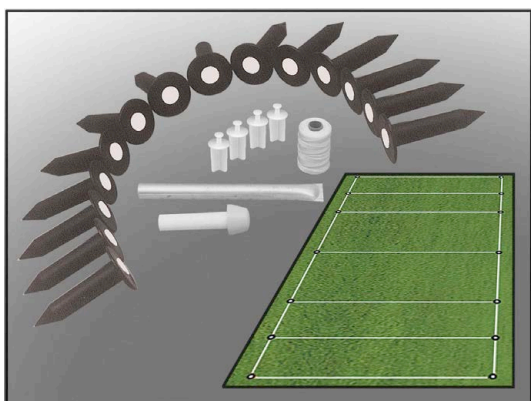

### MARKSMART™ INTRAMURAL LINING PACKAGE

- Most intramural and club sports require 14 line intersection reference points of the field
- Everything you need to establish permanent reference locations for flag football, lacrosse, field hockey, rugby and others
- Set includes: 14 sockets w/plugs and installation accessory kit

**MKILP14**

\$199<sup>99</sup> EA

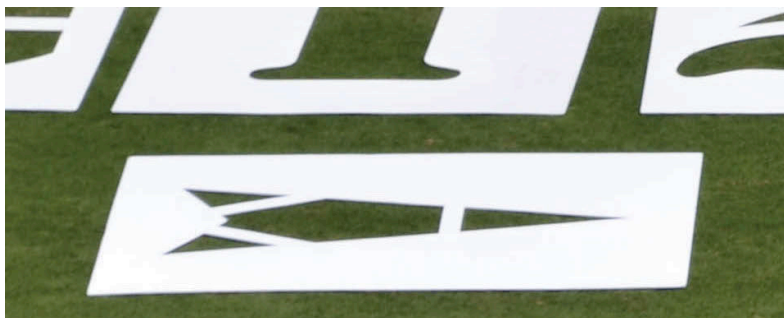

### PRO STYLE FIELD STENCILS

- Durable 1/8" flexible plastic stencils (Low-Density Polyethylene, LDPE)
- Can be rolled up for storage, and then flattened back out without any curl
- Sheds paint with ease and won't crack or break
- Each piece measure 8' x 4' with 6" numbers
- Standard Package contains: G, 1,2,3,4,5,0
- Deluxe Package contains: G, 1,2,3,4,5,0, hashmark, directional arrow

1461151	Standard Package	\$859 <sup>99</sup> SET
1461152	Deluxe Package	\$1,199 <sup>99</sup> SET
1461153	Individual Number	\$139 <sup>99</sup> EA
1461154	Directional Arrow	\$139 <sup>99</sup> EA
1461155	Hash Mark	\$419 <sup>99</sup> EA

### FM ACCESSORIES

#### GROUND SOCKET CAPS

- 12 pack of plugs for MarkSmart ground sockets
- Use color coded cap for multiple field configurations

Color Options: **Orange, White, Yellow.**

**MKA103Y** Caps Only - Specify Color \$21<sup>99</sup> DZN

#### GROUND SOCKET WITH CAP

- Individual 8" ground socket with plug

**MKA101** Ground Socket with Plug \$12<sup>99</sup> EA

#### HEAVY DUTY POLYESTER TWINE IN 500 FOOT ROLL

- Heavy duty twisted polyester rope.

**MKA102** \$20<sup>99</sup> EA

#### GROUND SOCKET LINING PEGS - 10/SET

- 10 pack of lining pegs for MarkSmart lining system
- Insert in ground sockets to attach twine

**MKA104** \$19<sup>99</sup> SET

#### GROUND SOCKET AUGER

- Use to set your ground sockets in place
- Attaches to any standard drill; size: 3/8" shaft, 1 1/4" diameter, 12" length

**MKGSAT2** \$34<sup>99</sup> EA

#### GROUND SOCKET PUNCH-PILOT HOLE TOOL

- Easy to use pilot hole tool for ground socket installation
- Helps to remove soil/dirt and create a crevice for ground socket insertion

**MKA105** \$44<sup>99</sup> EA

#### PAIR OF GROUND SOCKET SETTERS

- Designed to be placed in the ground socket so you can hit these instead of the ground socket directly

**MKA106** \$7<sup>99</sup> PR

#### TWINE OR CORD REEL - NO TWINE INCLUDED

**MKTCR10** \$24<sup>99</sup> EA

#### TWINE REEL WITH 500 FEET OF HEAVY DUTY POLYESTER ROPE

Includes 500 feet of heavy duty polyester twine

**MKTCR638** \$35<sup>99</sup> EA



**NEW!**

### DURASTRIPE MARKING PAINT

- 20oz cans with 18oz by volume
  - Non-clogging, cans will empty completely
  - Safe for user, environment and all varieties of grass
  - Extremely durable, will not wash away with rain and elements
  - Aerosol cans come standard with a custom "T" spray for a crisp, wide athletic field lines
- Color Options: **Colt Gray, Dark Blue, Lite Brown, Lt Purple, North Carolina Blue, Team Gold, Turf Green, Aluminum, Black, Brown, Burgundy, Burnt Orange, Cardinal, Clear, Columbia Blue, Forest Green, Gold, GRAY, Green, Maroon, Navy, Orange, Pink, Purple, Red, Royal, Tan, Teal, Team Orange, Vegas Gold, White, Yellow.**



1460342

Case of 12 Cans-Specify Color

\$84.99 CASE ★



**NEW!**

### STRIPING MACHINE WITH 10" WHEELS

This striping machine is perfect for everyday field striping. It's 10" diameter wheels make for a smooth roll and less effort.

1460691

\$239.99 EA ★



**NEW!**

### STRIPING MACHINE ALL TERRAIN WHEELS

This machine is equipped with large diameter ALL TERRAIN wheels that roll smoothly and maneuver easily over rough field conditions.

1460692

\$259.99 EA ★



### ECOLINER™ BATTERY POWERED FIELD STRIPING MACHINE

- Features a heavy duty, diaphragm pump powered by a 12-volt deep cycle battery, never flat tires and all steel construction
- Quickly paint professional quality lines for hours on a single battery charge
- Simply, place a 5-gallon pail of premixed paint on the machine and you are ready to mark your field
- No pressurized tanks. No need to release pressure to add paint or clean. No high-pressure pump output to prohibit operator injury
- Line width is fully adjustable from 2"-6", allowing for greater flexibility to meet your field marking needs
- Equipped with a quick charge 120V plug in battery charger to provide the fastest charging time available.

**18 Month Limited Warranty**

5NSECLNR

5 Gallon Capacity

\$2,149.99 EA



### FIELDLAZER™ STRIPER

- Exclusive tall-wheel cart rolls easily over ruts and cleat marks
- Easy out filter makes tip clogs a thing of the past
- 35cc Honda 4 stroke engine
- Three semi pneumatic 14" tires
- 900 psi
- Gas tank holds .65 gallons and should be good for 45 minutes
- Adjustable spray shields make line width changes from 4"-8" fast and easy with no tools
- Siphons from the original 5 gallon paint container to eliminate tank and pot cleaning hassles
- Fold-down handle makes transportation easy; Weight: 80 lbs.

1179477

1236286

5 Gallon Capacity  
30" Tip Extension

\$4,289.99 EA

\$104.99 EA



# RAZOR

## FEATURES



### ***MOISTURE WICKING FABRICS***

Moisture wicking inner and outer fabrics featuring Aegis antimicrobial treatment enhance cooling performance and inhibit bacteria growth.



### ***ADJUSTABLE PROTECTIVE PADS***

Perforated closed cell foam clavicle channel pads (All models) and EVA foam deltoid pads (RZ15 only) can be positioned or removed for precise fit and coverage in the key hitting areas.

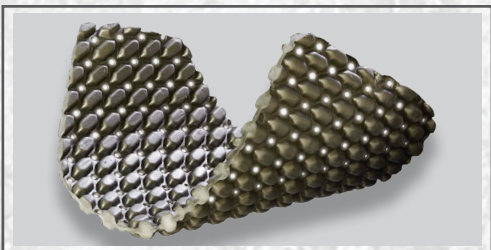

### ***COMPRESSED HEX FOAM***

Compressed closed cell HEX Foam features 3D channels and perforations to promote airflow, moisture evaporation and cooling performance.





***PAD-LOC BUCKLE SYSTEM***

Industry first belt attachment system, features injection molded plastic buckle/housing with automotive grade web strap and padded, protective buckle slider pad. The “tongue and groove” buckles lock into place in the recessed housing for a flush mount and no grab points.

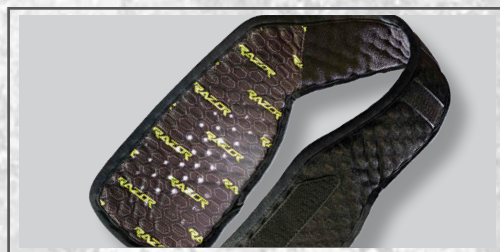

***REMOVABLE COMFORT LINER***

HEX Foam comfort liner attaches with hook and loop fasteners and can be removed for hand washing and air drying.



***STERNUM/SPINE PROTECTIVE PADS***

Floating perforated and layered EVA and Compressed HEX Foam sternum and spine pads provide an extra layer of protection without sacrificing flexibility.



**GEAR**  
**PRO·TEC**

**RAZOR**





# RZ7

## SKILL

- Slim profile with shorter caps for increased mobility and unrestricted arm movement for the most flexibility
- Average weight - 4.55 lbs. (size L)

**1388367**

Specify Size (SM - 2XL)

**\$359.99** EA ★

SIZE	SM	MD	LG	XL	2XL
<b>SHOULDER</b>	16"-17"	17"-18"	18"-19"	19"-20"	20"-21"
<b>CHEST</b>	36"-38"	38"-40"	40"-42"	42"-44"	44"-46"



# RZ15

## MULTI-POSITION

- Wider side cut, extended cap and protective deltoid pad for the most coverage and greatest protection in the RAZOR line up
- Average weight - 4.85 lbs. (size XL)

**1388373**

Specify Size (SM - 2XL)

**\$359.99** EA ★

SIZE	SM	MD	LG	XL	2XL
<b>SHOULDER</b>	16"-17"	17"-18"	18"-19"	19"-20"	20"-21"
<b>CHEST</b>	36"-38"	38"-40"	40"-42"	42"-44"	44"-46"



# RZ55

## OL/DL

- Extremely narrow side cut for smallest surface area and generous neck opening for freedom of movement gives big guys what they need for performance in the trenches
- Molded foam caps for reduced weight and snug fit
- Average weight – 4.35 lbs. (size XL)

1388380

Specify Size (MD - 3XL)

\$359.99 EA ★

SIZE	MD	LG	XL	2XL	3XL
SHOULDER	17"-18"	18"-19"	19"-20"	20"-21"	21"-22"
CHEST	38"-40"	40"-42"	42"-44"	44"-46"	44"-48"



# RAZOR

## RIB PROTECTOR

- Sas-Tec Foam with corrugated exterior shell located in center back for superior impact absorption
- Compressed Hex foam with rigid side and front panels provides best in class protection, moisture evaporation and cooling performance.
- Universal T-nut and screw attachment fits all Razor and Z-Cool shoulder pads as well as most competitor's shoulder pads

1455078

Specify Size (SM - LG)

\$63<sup>99</sup> EA ★

SIZE	SM	MD	LG
WAIST	34"-38"	40"-44"	46" and up



# RAZOR

## BACK PLATE

- Features Compressed HEX Foam side panels with a SAS-TEC foam spine insert and corrugated exterior shell for maximum protection
- Universal T-nut and screw attachment fits all Razor and Z-Cool shoulder pads as well as most competitor's shoulder pads

RZ BACK PLATE	1390930	1388433
SIZE	SM	LG
DIMENSIONS	9.5"x6"	12"x7"
PRICE	\$32 <sup>99</sup>	\$37 <sup>99</sup>



# Z-COOL 2.0

## FEATURES



### IMPROVED EPAULET CURVATURE

Provides better shoulder coverage and fits modern jersey cuts

RIGID PLAS

### ADJUSTABLE DELTOID PAD SYSTEM



### PRO-LOC EPAULET DESIGN



### AC NOTCH-OUT WITH FIXED CAP PAD

Provides Acromioclavicular joint protection. No direct pressure on AC joint

### MOISTURE WICKING ANTI-MICROBIAL FABRIC



# Z-COOL 2.0 TECHNOLOGY

## CLAVIC STERNUM PROTECTION



### 1.5" BIOTHANE BELTS WITH NON-CUT BUCKLES

With 3-point rear strap attachment for better fit (Patent #D543,488)

## EXCLUSIVE AIR RELEASE™ SYSTEM



Adjustable and removable waterproof clavic channel pads provide a custom fit for individual player comfort and maximum safety. Patent #5,701,611



Layered foam cushions impact by quickly forcing air through vents in the pad sidewall. Each pad quickly rebounds to be ready for the next impact.

## Z-COOL® MOISTURE TRANSFER SYSTEM

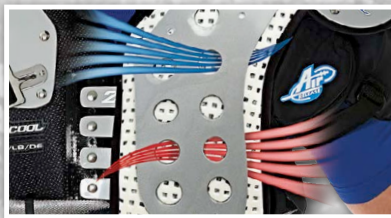

Patented High Impact Inner Poly Arch design featuring vent holes front and back is sandwiched between two layers of 3-D Air Flow Brock® Foam and supported by an outside Poly Plate. Patent #7,168,104

## HOW Z-COOL® WORKS

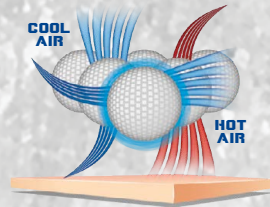

### 1. ACTIVE AIR CIRCULATION:

3-D Air Flow Brock® Foam allows air to circulate through the pad in three dimensions. As sweat coats the surface area of the waterproof foam beads, the airflow actively accelerates evaporation which is the key to body temperature cooling and post-game drying time.



### 2. IMPACT ENERGY DISPERSION:

Z-Cool® shoulder pads feature Brock® Foam giving them an advantage over the standard open cell foam. Upon impact, each bead in the Brock Foam padding dissipates and redistributes energy waves to the connected adjacent beads.

### 3. ENHANCED PERFORMANCE:

The benefits of Z-Cool® technology provide athletes with an extra edge on the competition. A perfect combination of materials and engineering to cool the athlete's body by wicking away perspiration and protecting athletes with superior impact dispersion. An ultra-light design that allows athletes at all levels to perform at their very best... in the very best.



## ZC SKILL

- Flat pad design for low profile with all of the features needed to provide protection and improved mobility required for all skill positions
- Extended flexible arches for superior speed and mobility that are rigid and durable enough to handle the big hits
- Lightweight design with extended arch protection features fixed cap pads, making this a good choice for read option quarterbacks, wide receivers and defensive backs.

1454155

Specify Size (XS - XL)

\$249<sup>99</sup> EA ★

SIZE	XS	SM	MD	LG	XL
SHOULDER	15"-16"	16"-17"	17"-18"	18"-19"	19"-20"
CHEST	34"-36"	36"-38"	38"-40"	40"-42"	42"-44"





## ZC MULTI POSITION

- Advanced technology provides excellent impact absorption, ideal body fit and maximum freedom of movement
- This pad offers the best protection for all aspects of the game
- Wider front and back arch coverage designed for bigger players needing maximum protection on impact

1454161

Specify Size (SM - 2XL)

\$249.99 EA ★

SIZE	SM	MD	LG	XL	2XL
SHOULDER	16"-17"	17"-18"	18"-19"	19"-20"	20"-21"
CHEST	36"-38"	38"-40"	40"-42"	42"-44"	44"-46"



BACK



FRONT





## OL/DL

- Super streamlined arch cut delivers unsurpassed shoulder and arm mobility
- Deep, open neck design offers greater range of motion and unrestricted lateral head movement.

1454168

Specify Size (M - 3XL)

\$249<sup>99</sup> EA ★

SIZE	MD	LG	XL	2XL	3XL	4XL
SHOULDER	17"-18"	18"-19"	19"-20"	20"-21"	21"-22"	22"-23"
CHEST	38"-40"	40"-42"	42"-44"	44"-46"	46"-48"	48"-50"





# POST GAME REACTION

*“Our players love the fit and feel of our Gear shoulder pads. We have used them since our football program’s inception in 2009. Our absence of shoulder and upper-body injuries, combined with competitive pricing and unrivaled customer support shows that you can’t go wrong with Gear products.”*

**Adam Howard - Head Football Coach, Notre Dame College of Ohio**

*“I’ve found that Gear shoulder pads have provided our program with great protection for our athletes. We have used the Gear pad for the last 10+ years and their durability is the best by far. Many other pads have failed during reconditioning within 5 years of being purchased. Gear pads stay in great shape...even after 10 years of use!”*

**John Livengood - Head Football Coach – Norwalk St. Paul High School**

*“The Z-Cool pads provide great protection for our players, and the fact that they are lightweight helps our players’ performance on the field. The Z-Cool Pads are also very “clean” pads. They dry quickly and don’t hold moisture.”*

**Greg Stubbs - Head Football Coach - Tennessee High School**

*“I have been buying Z-Cool shoulder pads for the past five years. Here at Boise State, our players love the protection, light weight and added mobility the Z-Cool shoulder pads provide.”*

**Dale Holste - Head Equipment Manager, Boise State University**

*“Gear Shoulder Pads have made a huge impact in my program. I have much fewer injuries and far less complaints when my players are wearing these pads. Gear Pads have become the overwhelming favorite among my players.”*

**Mike Kohl - Head Football Coach, Bradley Bourbonnais High School**

*“This year we purchased the Gear shoulder pads. After taking time to research the pads I found them true to what they promote. As an athletic trainer I am first trying to protect our athletes from injuries in football. I truly like the way the shoulder pad fits, especially with the adjustable padding at the AC joint, allowing me to custom fit each player based on their shoulder girth. The moisture management system with the material built into the pads has helped the athletes stay cool along with helping prevent issues related to moisture left in the shoulder pads. This has drastically cut down problems with Staph and other bacterial germ diseases. Our quarterback loves the fit and mobility he has with the Gear Z-Cool QB pads. I like the quality protection these pads provide and will continue to look at Gear pads for future football seasons.”*

**Kris Knapp - Head Trainer/Equipment Manager - Ontario High School**



## X7-SKILL

- Light weight low profile flat pad design
- Shorter arch design with smaller footprint provides greater mobility while still offering best in class protection
- Built-in back plate
- Recommended for QB/WR/DB or similar Skill positions

**1454175** Specify Size (SM - XL) ~~\$~~**179.99** EA ★

SIZE	SM	MD	LG	XL
SHOULDER	16"-17"	17"-18"	18"-19"	19"-20"
CHEST	36"-38"	38"-40"	40"-42"	42"-44"





## X-15 MULTI-POSITION

- Flat pad design provides optimum combination of protection and mobility for multiple positions
- Short front arch for extended range of motion with extended rear arch for added protection
- Narrower arch design for greater hands up movement
- Dual Biothane and Elastic belt system for secure fit
- Multi-Position pad recommended for RB/DB/TE/DE or similar positions requiring mobility and added protection

**1454181** Specify Size (SM - 2XL) **\$179.99** EA ★

SIZE	SM	MD	LG	XL	2XL
SHOULDER	6"-7"	17"-18"	18"-19"	19"-20"	20"-21"
CHEST	36"-38"	38"-40"	40"-42"	42"-44"	44"-46"



## X55-OL/DL

- Most protective X3 model offering greater coverage for blocking and tackling
- Narrower arch design for greater hands up movement
- Specially designed for larger players such as OL/DL/DE/TE positions

**1454187** Specify Size (MD - 3XL) **\$179.99** EA ★

SIZE	MD	LG	XL	2XL	3XL
SHOULDER	17"-18"	18"-19"	19"-20"	20"-21"	21"-22"
CHEST	38"-40"	40"-42"	42"-44"	44"-46"	46"-48"

# YOUTH



## Z-COOL 2.0

### JV/YOUTH

- NEW Carbon Fiber look for an intimidating presence
- Z-Cool® Moisture Transfer System Patent #7,168,104
- Moisture Wicking Anti-Microbial Interior Fabric
- AC Notch-Out With Cradle Pad
- Adjustable Clavicle Pad System with Fixed Cap Pad
- Z-Cool® Plastic Inner Arch Design Patent #7,168,104
- 1.5" Belts With Non-Cut Buckles, Patent #D543,488
- PRO-LOC™ Epaulet Design Rigid Plastic Sternum Protection

1454455

Specify Size (XS - 3XL)

\$139.99 EA ★

SIZE	XSM	SM	MD	LG	XL	2XL	3XL
SHOULDER	12"-13"	13"-14"	14"-15"	15"-16"	16"-17"	17"-18"	18"-19"
WEIGHT	30-45 lbs.	40-60 lbs.	60-80 lbs.	75-100 lbs.	95-120 lbs.	115-140 lbs.	135-160 lbs.



### JV/YOUTH



- For Youth, Middle School or JV
- Perforated arch foam system allows for quick drying
- Low profile flat pad construction with vented arch plastic
- Rigid plastic sternum protection
- AC joint notch-out with cradle pads
- 1.25" Belts with non-cut buckles

1454463

Specify Size (XS - 3XL)

\$79.99 EA ★

SIZE	XSM	SM	MD	LG	XL	2XL	3XL
SHOULDER	12"-13"	13"-14"	14"-15"	15"-16"	16"-17"	17"-18"	18"-19"
WEIGHT	30-45 lbs.	40-60 lbs.	60-80 lbs.	75-100 lbs.	95-120 lbs.	115-140 lbs.	135-160 lbs.





### BACK PLATE

- Air flow foam evaporative cooling system
- Lightweight reinforced polycarbonate protective plate
- NEW screw and T-nut attachment system fits all models of GEAR Pro-Tec shoulder pads as well as most competitors (does not fit Z-Cool OL/DL Pro Select, DL/TE/DE and X2 Air X-16 pads)

<b>1317350</b>	Varsity	\$28. <sup>49</sup> EA ★
<b>1312379</b>	Youth	\$22. <sup>99</sup> EA ★



### RIB COMBO PROTECTOR

- Air flow foam evaporative cooling system
- Lightweight reinforced polycarbonate protective plate
- NEW Screw & T-Nut attachment system designed to fit all models of Gear Pro-Tec shoulder pads
- Hook and loop front closure

<b>1312584</b>	S (34"-38")	\$54. <sup>99</sup> EA ★
<b>1312577</b>	M (40"-44")	\$54. <sup>99</sup> EA ★
<b>1312560</b>	L (46"+)	\$54. <sup>99</sup> EA ★
<b>1317336</b>	Youth M (26"-30")	\$46. <sup>99</sup> EA ★
<b>1317343</b>	Youth L (30"-34")	\$46. <sup>99</sup> EA ★



### SHOULDER PAD RESTRAINT CUFF

- Helps minimize hyperextensions
- Slash proof biothane straps
- Air flow technology for cooling
- Universal fit for any belt system shoulder pad

<b>1456008</b>	S/M	\$89. <sup>99</sup> EA ★
<b>1456009</b>	L/XL	\$89. <sup>99</sup> EA ★



### EQUIPMENT BAG

- 32" x 13" x 16"
- Separate compartments for shoulder pads and helmet

<b>1312836</b>	\$35. <sup>99</sup> EA ★
----------------	--------------------------



### NECK ROLL

- One size fits all
- Foam filled nylon fabric
- Attaches with screws and t-nuts

<b>1317312</b>	Varsity	\$26. <sup>99</sup> EA ★
<b>1317329</b>	Youth	\$19. <sup>49</sup> EA ★



### WALK THRU AND INJURY VEST

- Air flow foam evaporative cooling system
- Lightweight protection

<b>1317299</b>	S (36"-38")	\$56. <sup>99</sup> EA ★
<b>1317305</b>	M (38"-42")	\$56. <sup>99</sup> EA ★
<b>1312621</b>	L (44"-46")	\$56. <sup>99</sup> EA ★
<b>1312645</b>	XL (46"-48")	\$56. <sup>99</sup> EA ★
<b>1312591</b>	2XL (48"-52")	\$56. <sup>99</sup> EA ★
<b>1312607</b>	3XL (52"-56")	\$56. <sup>99</sup> EA ★



### 3" ROUND KNEE PADS

- Air flow and evaporative cooling system
- Sold in pairs

<b>1388428</b>	3" ROUND	\$7. <sup>99</sup> PR ★
----------------	----------	-------------------------



### Z-COOL KNEE PADS

- Air flow and evaporative cooling system
- Sold in pairs

<b>1312522</b>	XS	4"L x 3"W	\$9. <sup>99</sup> PR ★
<b>1312515</b>	S	5"L x 4"W	\$10. <sup>99</sup> PR ★
<b>1312508</b>	M	5.5"L x 4.5"W	\$10. <sup>99</sup> PR ★

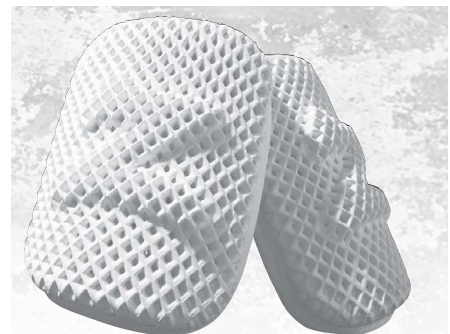

### Z-COOL® THIGH GUARDS

- Air flow and evaporative cooling system
- Sold in pairs

<b>1312706</b>	S	7"L x 5"W	\$15. <sup>99</sup> PR ★
<b>1312690</b>	M	8"L x 6"W	\$17. <sup>99</sup> PR ★



**4-STACK SHOULDER PAD RACK**

- Base with rectangular channel design increases strength and stability
- 4 heavy duty swivel casters for easy movement
- Holds up to 60-80 pads (Depending on pad size)

**1378670** 68"H x 24"W x 60"L - 65 lbs \$499<sup>99</sup> EA ★



**COMBO HELMET/SHOULDER PAD RACK**

- Rigid base design increases strength and stability
- 4 heavy duty swivel casters for easy movement
- Holds up to 30 Shoulder Pads and 32 Helmets

**1378672** 68"H x 24"W x 30"L - 55 lbs. \$434<sup>99</sup> EA ★



STORAGE BAG

**FOOTBALL HELMET CART**

- Constructed of 1" O.D. black powder coated steel tubing
- Heavy duty urethane swivel wheels - 2 with brakes
- 5 welded shelves make for easy assembly
- Will hold 50 football helmets with masks (can also be used for lacrosse helmets, batting helmets, basketball, volleyballs, etc.)
- Fits through standard doorways
- 64"H x 24"W x 61"L - 61 lbs.

**1378673** Storage Bag - 32" x 36" (Specify Color) \$499<sup>99</sup> EA ★  
**SNBCNET** \$17<sup>99</sup> EA ★



**SHOULDER PAD HANGER RACK**

- Constructed of 1.5" black powder coated steel tube
- 4" heavy duty urethane swivel casters
- Holds up to 28 shoulder pads, any size
- Fits through standard doorways
- Allows pads to keep their shape and air dry

**1453172** 60" L x 27.5" W x 73.5" H - 71 lbs. \$344<sup>99</sup> EA ★

## SCRIMMAGE HELMET COVERS (12-PACK)

ONE SIZE FITS ALL

- 1/2" gripper elastic bottom to prevent slippage
- 90% Cotton/10% Lycra

Color Options: **Black, Gold, Orange, Royal, Scarlet.**

**1071948**

\$64<sup>99</sup> DZN



## ULTRA-LITE KNEE PADS

- High density ultra-lite foam

<b>FBULKPA</b>	8.25" Adult	\$10 <sup>99</sup> PR ★
<b>FBULKPI</b>	7.5" Intermediate	\$10 <sup>99</sup> PR ★
<b>FBULKPY</b>	7" Youth	\$10 <sup>99</sup> PR ★



## ULTRA-LITE THIGH PADS

- High density ultra-lite foam with plastic impact plate

<b>FBULTPA</b>	9" Adult	\$19 <sup>99</sup> PR ★
<b>FBULTPI</b>	8" Intermediate	\$18 <sup>99</sup> PR ★
<b>FBULTPY</b>	7" Youth	\$17 <sup>99</sup> PR ★



## ULTRA LITE 3-PIECE HIP PADS

- High density ultra-lite foam reinforced with plastic

<b>FBULHP3A</b>	Adult	\$20 <sup>99</sup> SET ★
<b>FBULHP3I</b>	Intermediate	\$17 <sup>99</sup> SET ★
<b>FBULHP3Y</b>	Youth	\$13 <sup>99</sup> SET ★



## ULTRA LITE TAIL PADS

- High Density ultra-lite foam reinforced with plastic (7"L)

<b>FBTSP</b>	Slotted	\$6 <sup>99</sup> EA ★
<b>FBTSPSNAP</b>	Snaps	\$6 <sup>99</sup> EA ★



## YOUTH 7PC ULTRA LITE PAD SET

- High density ultra-lite foam reinforced with plastic

<b>FBUL7YSS</b>	Sliding Snaps	\$37 <sup>99</sup> SET ★
<b>FBUL7YSLP</b>	Slotted	\$32 <sup>99</sup> SET ★



**NEW NEON COLORS!**

## LIGHTWEIGHT SCRIMMAGE VESTS

- Polyester mesh vest
- Reinforced neck and armholes
- Elastic waistband

Color Options: **Black, Gold, Kelly, Neon Green, Neon Orange, Neon Yellow, Orange, Purple, Royal, Scarlet.**

**C46Y**

K thru 3rd Grade

\$6<sup>99</sup> EA ★

**C46**

4th-6th Grade, Middle School & Up

\$7<sup>99</sup> EA ★

**C47N**

Adult (# 1-12) GO,KE,OR,PU,RO,SC,BK only

\$91<sup>99</sup> DZN ★



## REVERSIBLE SCRIMMAGE VESTS

- Polyester mesh construction
- Reversible jerseys with elastic bottom

Color Options: **Dark Green/Gold, Orange/Gold, Red/Black, Royal/Gold, Royal/Red, Silver/Black.**

**126271I**

Adult

\$89<sup>99</sup> DZN ★

**1262773**

Youth

\$89<sup>99</sup> DZN ★



## HEAVY DUTY VINYL MESH PRACTICE VEST

- Wide elastic Velcro® straps
- Heavy duty vinyl mesh
- Slips over helmet and shoulder pads easily without assistance
- Light and breathable but very durable
- 17"W x 20"L

Color Options: **Black, Blue, Gold, Grey, Kelly Green, Orange, Red, White.**

**1398268**

Specify Color (12/Pack)

\$289<sup>99</sup> DZN

## HEAVY DUTY SCRIMMAGE VEST

- Polyester Porthole mesh, elastic waist, large neck and arm holes.
- Sewn with no shoulder seams to reduce ripping and extend life.

Color Options: **Black, Gold, Kelly, Purple, Royal, Scarlet.**

**C48**

\$12<sup>99</sup> EA ★



# FLAG-A-TAG®



## SONIC FLAG BELTS

- Featuring Flag-A-Tag's patented release system
  - Sonic belts emit an audible "pop" to signal the play is dead
  - Built for institutional use
  - Flag size: 2"W x 17-1/4"L
  - Sold by dozen per size/color
- Color Options: **Gold, Kelly, Royal, Scarlet, White.**

**8674223** 42" FLAG BELTS \$102<sup>99</sup> DZN ★  
**8675223** 52" FLAG BELTS \$102<sup>99</sup> DZN ★

SOCKET & PLUNGER "POPS" WHEN PULLED FROM SOCKET



SOCKET ANGLES BELT AWAY FROM PLAYER



## PROGRAM KIT

- Designed to outfit two teams of twelve players
- Includes 24 belts with flags, 2 storage rings, and 1 flag football rule book
- Select either 42" or 52" belts
- Choose two colors: Gold, Kelly, Royal, Scarlet or White

**8671000** \$279<sup>99</sup> SET ★

## JUNIOR FLAG FOOTBALL PACK

All the equipment needed for a game!

Package Includes:

- 24 - 42" Flag belts with flags (12 each Red and Yellow)
- 24 - C46 Lightweight Adult mesh vests (12 each Red and Yellow)
- 1- Junior size rubber football
- 8 - Game cones (12")
- 2- Official's pinnies
- 1- Stopwatch
- 2 - Flag belt storage rings
- 1 - USFTL rule book and officials manual
- 1- Wheeled deluxe storage/transport bag

**1238037** 64 Pieces \$499<sup>99</sup> PACK ★



## FLAG-A-TAG® STORAGE RINGS

- Provides easy storage for all types of flag belts
- Holds 12 - 18 belts

**8671010** \$13<sup>99</sup> EA ★



## SONIC CONVERSION PACKAGE

- Converts a 2 flag belt into a triple flag belt
  - Includes 12 sockets, 12 Stems, and 12 flags
- Color Options: **Gold, Kelly, Royal, Scarlet, White.**

**8670023** \$49<sup>99</sup> DZN ★

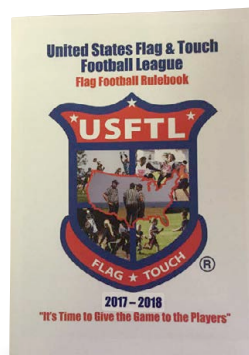

## USFTL RULE BOOK AND OFFICIALS MANUAL

- Standard rule book for all USFTL leagues
- Rule Highlights include: Definitions, Official's Manual, Games, Playing Fields, Equipment, Periods, Time factors, Overtime, Substitutions, Scoring, Conduct, Penalties, Ranking System ...and much more

**86703XXX** \$24<sup>99</sup> EA ★

## FLAG FOOTBALL BELTS

Three flags permanently sewn onto the web belt. Entire belt comes off - no parts to lose! Belts are washable.

- Vinyl coated polyester flag will not tear
- Flag size: 2 1/4"W x 14 1/2"L
- Heavy duty polyethylene "gator clip"
- Adjusting slide for sizing
- Belt clips are color coded to indicate size
- Specify size when ordering:
- SMALL: 22" - 32" RED Belt Clip
- MEDIUM: 28" - 38" YELLOW Belt Clip
- LARGE: 32" - 44" BLUE Belt Clip
- X-LRG: 38" - 52" GREEN Belt Clip

<b>1149487</b>	Red Flags - Specify Size	\$5 <sup>99</sup> EA ★
<b>1149524</b>	Yellow Flags - Specify Size	\$5 <sup>99</sup> EA ★
<b>1149562</b>	Blue Flags - Specify Size	\$5 <sup>99</sup> EA ★
<b>1149609</b>	Green Flags - Specify Size	\$5 <sup>99</sup> EA ★

## ADJUSTABLE FLAG BELTS

- Each belt includes 2 flags
- Flags attached with hook-and-loop belt attachment that slide over belt
- Flag size: 2"W x 16 1/4"L
- Steel D-ring belt loops for sizing
- One size fits most - belt length 42"

Color Options: **Blue, Red, Yellow.**

<b>MSFB</b>	Belts With Flags	\$3 <sup>99</sup> EA ★
<b>1234749</b>	Belts Only	\$7 <sup>99</sup> SET OF 6 ★
<b>MSFLAGS</b>	Flags w/Belt Attachment Only	\$7 <sup>99</sup> SET OF 6 ★

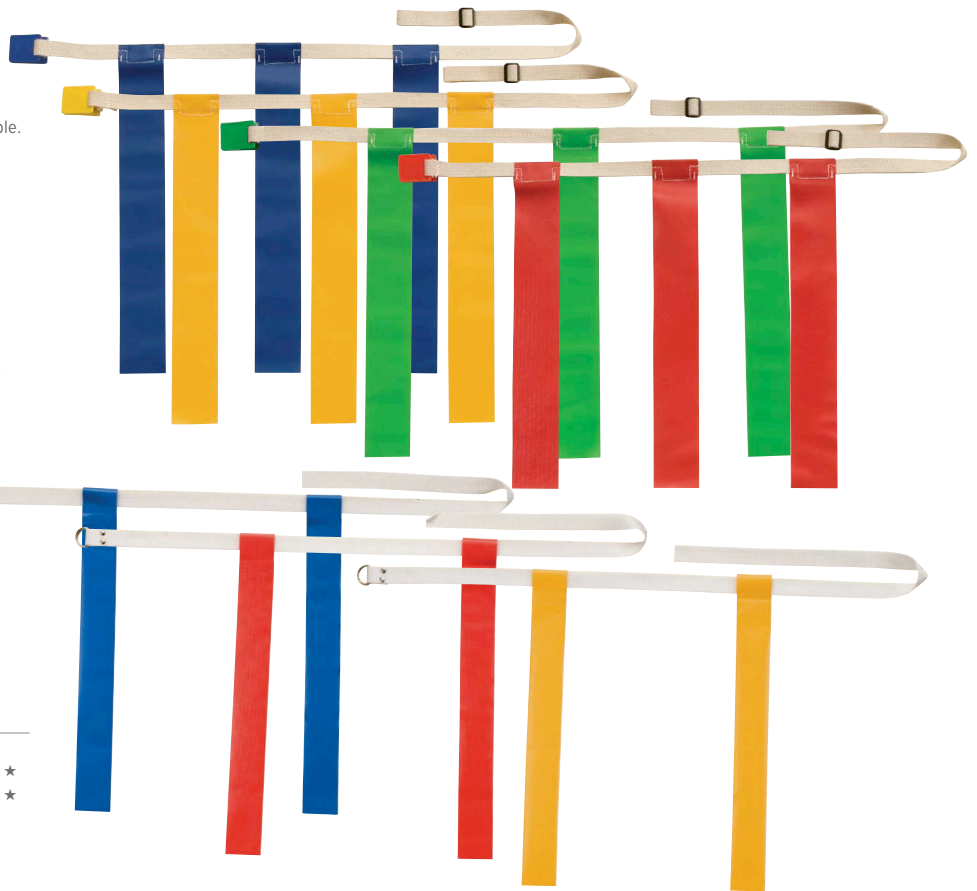

## TRIPLE THREAT DOWN BOX & SCOREBOARD

- Combines the features of a down box and scoreboard into a single unit
- Score can be shown on both sides of the down indicator
- Made of strong light weight PVC material
- Easily disassembles for storage
- 7'H when assembled
- Includes plastic numbers, 2 dry erase score sheets with markers and pole



**1196160** \$207<sup>99</sup> EA ★

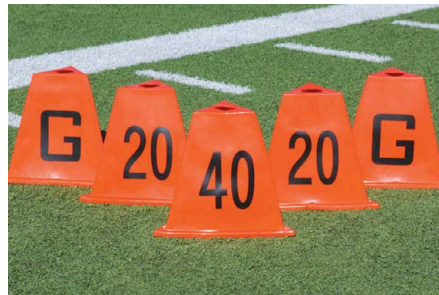

## STACKABLE SIDELINE MARKERS

- 13"H, 3 sided pyramid shaped markers
- Made of tough, flexible vinyl
- Stackable for easy storage
- 5-piece set includes: 2-G's, 2-20's, 1-40
- 11-piece set includes: 2-G's, 2/10's, 2/20's, 2/30's, 2/40's, 1/50

<b>1245127</b>	5 Piece Set for Flag Football	\$229 <sup>99</sup> SET ★
<b>1245134</b>	11 Piece Set	\$429 <sup>99</sup> SET ★



## DAY/NIGHT SIDELINE MARKERS

- Soft, crushable foam core inside durable vinyl cover
- Folding design for flat storage
- Hook and loop fasteners with weighted bottom to maintain upright position
- 15"H X 15"W with 13"H numbers
- Includes 2-G's, 2-20's and 1-40

**1249354** 5 Piece Set for Flag Football \$181<sup>99</sup> SET ★

## OFFICIAL'S PENALTY FLAG

- Regulation size 15" x 15" nylon with a weighted center
- Available in yellow only

**FBREFFLG** \$10<sup>99</sup> EA ★



## BALL SPOTTER

- 3 1/2" diameter pliable rubber disc

<b>1240245</b>	Orange	\$13 <sup>99</sup> EA
<b>1240252</b>	Yellow	\$13 <sup>99</sup> EA



## PYLONS

- Bright, fluorescent orange
- Safe foam filled vinyl
- 18"H x 4"W x 4"D
- Set of 4

**MSWPYLON** Weighted Anchorless \$51<sup>99</sup> SET OF 4 ★





### PORTABLE COOLING SYSTEM

- Frame constructed of heavy wall powder coated steel
- Cools temperature in front of fan 10-20 degrees; up to 50' away
- Transports easily on two 10" "No Flat" wheels
- Includes: 50 PSI pump, 24" fan, 5 brass misting heads, 20 gallon tank (provides approximately 7 hrs. of operation)
- Dimensions: 68"H x 28"W x 31"D - 135 lbs. (empty)
- Requires 115V electrical outlet
- Warranty: Fan - 2 Years; Pump - 1 Year; Parts - 1 Year; Frame - 5 Years

1240405

\$2,399<sup>99</sup> EA ★



### HYDRATION PACKAGES



#### GAME DAY HYDRATION PACKAGE

- The perfect solution for keeping athletes cool, hydrated and ready for peak performance on game day
- Package includes: 2 - Portable Mister Cooling Systems (SPCMIST) and 1 - Power Tanker with Cart (SPCPT)
- Water bottles sold separately

1371360

\$4,999<sup>99</sup> PACK

\$5260 RETAIL VALUE

SAVE 30%



#### PRACTICE HYDRATION PACKAGE

- Hydrate more players faster, so more time can be spent practicing, with 20 total drinking stations
- Package includes: 2 - Powered Team Drinkers (SPCPTD) and 1 - Drinking Station (SPCDS)

1371361

\$2,749<sup>99</sup> PACK

\$2800 RETAIL VALUE

SAVE 25%

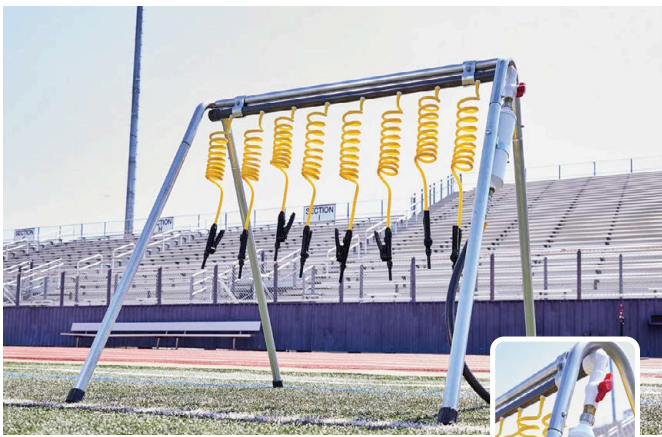

### DRINKING STATION WITH FILTER

- Galvanized steel tubing frame with removable legs for easy transport and storage
- Drinking tube is made of non-corrosive PVC
- In-line filter for cleaner fresher water
- Includes 8 drinking stations with shut-off nozzles
- Connects to a standard water hose (not included)
- Dimensions: 43"H x 53"L - 25 lbs



<b>1453185</b>	Complete Unit	<b>\$519<sup>99</sup></b> EA ★
<b>1453180</b>	Replacement Water Filter	<b>\$34<sup>99</sup></b> EA ★
<b>ZX3920094</b>	Flexible Hose Connection	<b>\$8<sup>99</sup></b> EA ★



### POWER TANKER WITH CART

- NEW & IMPROVED Cart design with translucent blue tank
- Constructed of steel tube frame with aluminum bottom deck and top utility shelf (water bottles not included)
- Drinking tube constructed of non-corrosive PVC
- Rides and steers smoothly on four heavy duty wheels with 10" pneumatic tires
- Front wheels swivel for easy maneuverability
- Equipped with optional use towing attachment
- Includes 8 coiled drinking hoses, sanitizing tablets, 35 gallon FDA, NSF approved tank
- Rechargeable 12V / 12amp Power Pack provides 8 hours of use
- Dimensions: 43"L x 20"W x 54"H - 140 lbs. (empty)

<b>1378677</b>	Complete Unit	<b>\$2,199<sup>99</sup></b> EA ★
----------------	---------------	----------------------------------

REPLACEMENT PARTS		
<b>SPCHOSE</b>	Coiled Hose and Shut Off	<b>\$46<sup>99</sup></b> EA ★
<b>SPCWAND</b>	Shut Off Assembly	<b>\$25<sup>99</sup></b> EA ★
<b>SPCBAT</b>	Replacement Battery	<b>\$99<sup>99</sup></b> EA ★
<b>ZX3930034</b>	Replacement Battery Charger	<b>\$114<sup>99</sup></b> EA ★
<b>SPC16</b>	Sanitizing Tablets (150/Bottle)	<b>\$10<sup>99</sup></b> BOT



### PORTABLE WATER CHILLER

- Cart constructed of heavy wall powder coated steel
- Add ice to the cooler, attach water hose (not included) and the copper coil inside the tank cools drinking water as it passes through to the drinking stations
- Transports easily on two 10" "No Flat" wheels
- Includes: 6 retractable coil drinking hoses w/ quick shut-off nozzles and 10 gallon cooler
- Dimensions: 50"H x 21"W x 25"D - 46 lbs.

<b>1240429</b>	<b>\$1,499<sup>99</sup></b> EA ★
----------------	----------------------------------



### POWERED TEAM DRINKER

- Cart constructed of heavy wall powder coated steel
- Drinking tube constructed of non-corrosive PVC
- Transports easily on two 10" "No Flat" wheels
- Includes: 6 Retractable coil drinking hoses with quick shut-off nozzles
- 20 gallon FDA, NSF approved translucent blue tank with sanitizing tablets
- Rechargeable 12V/12amp power pack provides 8 hours of use
- Dimensions: 50"H x 21"W x 25"D - 135 lbs. (empty)

<b>1240412</b>	Complete Unit	<b>\$1,699<sup>99</sup></b> EA ★
----------------	---------------	----------------------------------



### PRACTICE LACROSSE GOAL

- Constructed of 13-gauge, orange powder coated, 1 1/2" O.D. steel tubing
- Includes 4mm knotless nylon net, lacing cord and light weight ground anchors

**LACPRAGL**

50 lbs.

**\$229<sup>99</sup>** EA ★

## GOAL NETS

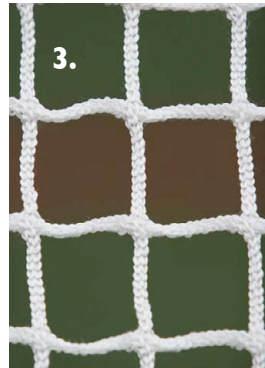
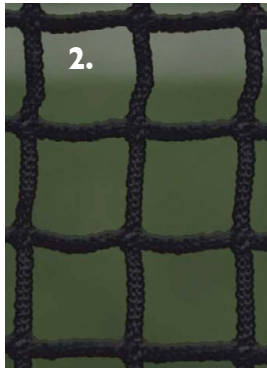
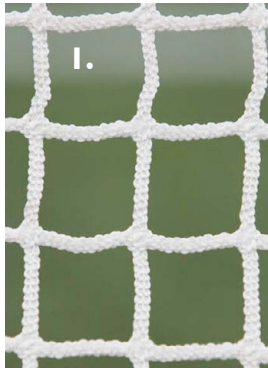

### 1. PROFESSIONAL LACROSSE NET

- White, 6mm knotless nylon lacrosse net, includes lacing cord

**1382863**

**\$279<sup>99</sup>** EA ★

### 2. CHAMPIONSHIP LACROSSE NET

- Black, 5mm knotless nylon lacrosse net, includes lacing cord

**1382861**

**\$199<sup>99</sup>** EA ★

### 3. PRACTICE LACROSSE NET

- White, 4mm knotless nylon lacrosse net, includes lacing cord

**1272925**

**\$145<sup>99</sup>** EA ★



- Mouthguards should be used in contact and non-contact sports to reduce the risk of concussion and mouth related injuries
- Top quality Dental Vinyl for greater strength, comfort, ease of speech and breathing
- Adult size is for ages 11 and up
- 30-second custom fit
- Youth Color Options w/Strap: Black, Gold, Scarlet, Royal
- Adult Color Options w/Strap: Black, Gold, Scarlet, Royal, Green, Maroon, Navy, Orange, Purple, Clear
- Adult Color Options Strapless: Black, Gold, Scarlet, Royal, Green, Maroon, Navy, Purple

**MSMOUT**

Adult w/ Strap - Specify Color

**\$21<sup>99</sup>** PACK OF 25

**1179620**

Youth w/Strap - Specify Color

**\$20<sup>99</sup>** PACK OF 25

**1403270**

Adult Strapless - Specify Color

**\$2<sup>99</sup>** EACH



### GEL MAX ADULT CONVERTIBLE MOUTHGUARD

- Gel Fit liner custom molds to teeth for tight, comfortable fit
- Exoskeletal Shock Frame
- Triple layer design with integrated breathing channel
- Convertible tether allows for use with or without a strap
- Adult Team packs of 48 sold in bulk poly bag
- Color Options: Black, Blue/Black

**1384275**

Specify Color

**\$15<sup>99</sup>** EA



## GAME/PRACTICE GOALS



### PRACTICE BOX LACROSSE GOAL

- 4'H x 4'W x 5'D
- Constructed of sturdy 1.5" diameter steel tube with orange powder coat finish
- Entire Goal is equipped with welded Lacing Rods
- Includes 4mm knotless nylon Net and Ground Anchor Stakes

1453175

\$179<sup>99</sup> EA ★



### OFFICIAL LACROSSE GOAL AND NET

- Constructed of 13-gauge, orange powder coated, 1.9" O.D. steel tubing and 3"W flat steel ground supports
- Includes 6mm knotless nylon net, lacing cord and heavy-duty ground anchors

LACOFFGL

125 lbs. Per Goal

\$1,199<sup>99</sup> PR ★



### MEN'S LACROSSE SCOREBOOK

- Spiral bound, 12 1/2"W x 12"H
- Comprehensive scorebook and record keeper
- Contains home and visitor scoring for 31 games

1377127

\$13<sup>99</sup> EA



### WOMEN'S LACROSSE SCOREBOOK

- Spiral bound, 11"W x 9 1/2"H
- Comprehensive scorebook and record keeper
- Contains home and visitor scoring for 29 games

1377128

\$13<sup>99</sup> EA



### MEN'S LACROSSE COACH'S BOARD

- Full field and half field writing surfaces front and rear
- Includes premium dry erase marker
- 8"W x 15 1/2"L

1388111

\$12<sup>99</sup> EA ★

### WOMEN'S LACROSSE COACH'S BOARD

- Full field and half field writing surfaces front and rear
- Includes premium dry erase marker
- 8"W x 15 1/2"L

1388112

\$12<sup>99</sup> EA ★

## BALLS

### LACROSSE BALLS

- Official NOCSAE/SEI stamped approved game balls meet NCAA and NFHS specifications
  - Availability in Men's(White) and Women's(Yellow)
  - Soft white practice ball is not NOCSAE approved
  - Brand of balls may vary
- 30 Day Limited Warranty**

LXB

White

\$28<sup>99</sup> DZN

LXBY

Yellow

\$28<sup>99</sup> DZN

LXBO

Orange

\$28<sup>99</sup> DZN

1725UPB

Soft White Practice

\$21<sup>99</sup> DZN

1380843

Bucket- 5 DZN White

\$141<sup>99</sup> EA ★





**BOWNET**

**PORTABLE BARRIER NET**

- Multi-sport portable barrier net
- Includes free carry bag with wheels

**1344097** 12 1/2'H x 21 1/2'W - 56 lbs. **\$589<sup>99</sup>** EA



**BOWNET**

**PORTABLE LACROSSE GOAL**

- Full size portable lacrosse goal
- Includes free carry bag with wheels

**1344073** 7'H x 7'W x 6'D - 25 lbs. **\$369<sup>99</sup>** EA



**BOWNET**

**PORTABLE LACROSSE GOAL CREASE (MEN'S)**

- Portable official 18' men's size lacrosse crease
- Includes internal weights for use on turf fields and grounds stakes for use on grass fields
- Includes free carry bag

**1344080** 18" Diameter - 9 lbs. **\$159<sup>99</sup>** EA

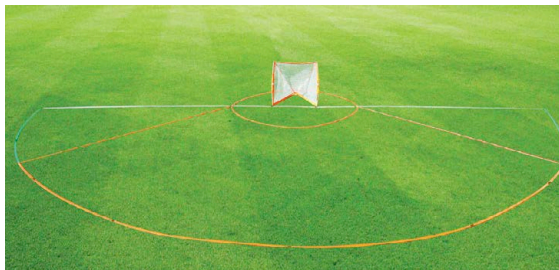

**BOWNET**

**WOMEN'S LACROSSE ARC**

- Allows you to set up the full goal markings, indoor or outdoors
- Can be staked down on grass or weighted down for the gym floor or turf
- Weight pockets every 4 meters around perimeter act as hash marks
- Goal and crease sold separately

**1388426** **\$559<sup>99</sup>** EA

**PORTABLE LACROSSE GOAL CREASE (WOMEN'S)**

- Portable official 17' womens size lacrosse crease
- Sets up in seconds
- Includes internal weights for use on turf and ground stakes for use on grass fields
- Goal and arc sold separately
- Includes free carry bag

**1388427** 17" Diameter - 8 lbs. **\$159<sup>99</sup>** EA



**BOWNET**

**BOX LACROSSE NET**

- Goal is constructed from a rigid steel frame
- Non-marking rubber feet to prevent damage to floors
- Includes lacrosse goal netting with nylon cover, ground frame, BOW-poles, and carrying bag for easy portability and storage

**1453020** **\$219<sup>99</sup>** EA



**BOWNET**

**HALO BARRIER NET**

- Fits around any standard full size lacrosse goal
- BOW™ poles and powder coated steel frame have non-marking rubber feet
- Includes halo barrier netting, ground frame, stakes, BOW™ poles, and carrying bag for easy portability and storage

**1453021** 12' x 9' **\$399<sup>99</sup>** EA



### PORTABLE BACKSTOP SYSTEM

- All-aluminum construction
- 3" round upright poles (4)
- 2" round bottom bars with net attachment to prevent ball from passing under the net
- Each 20' section can be angled to accommodate curved perimeters
- Closed bottom design is turf friendly
- Includes: 2mm 1-3/4" mesh net, 16 heavy duty Anchor Bags, Kwik Lock Net Clips
- 15'H x 60'L

1379269 Complete Set - 215 lbs **\$5,099<sup>99</sup>** EA ★ **S&H**  
 1379270 Replacement Net **\$619<sup>99</sup>** EA



### GOAL TARGET

- Available in two styles for two levels of challenge
- Improves shooting accuracy
- Made of durable polypropylene with reinforced edges
- Includes easy-to-attach bungee fasteners

1334555 Advanced **\$99<sup>99</sup>** EA

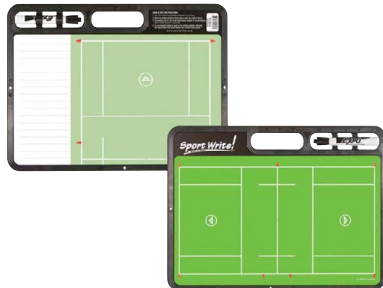

### PRO LACROSSE DRY-ERASE BOARD

- Large format enables entire team to see play
- 2 writing surfaces
- Includes premium dry erase marker
- 12 1/2"H x 16 1/2"W

1366487 Men's **\$32<sup>99</sup>** EA  
 1371672 Women's **\$32<sup>99</sup>** EA



### ALL PURPOSE BACKSTOP SYSTEM

- Backstop system measures 21'H x 65'W
- Constructed with (4ea) 3.5" galvanized steel poles
- Choice of 3mm 4" mesh or 1.75" mesh (275 lb. breaking strength)
- Easy on and off pulley system and (4ea) galvanized steel ground sleeves
- Weight: 360 lbs.

1071435 System with 1 3/4" Netting **\$4,699<sup>99</sup>** EA ★ **S&H**  
 1072230 Replacement Net - 1 3/4" Mesh **\$899<sup>99</sup>** EA ★

### BALL BOUNDARY SYSTEM

- Complete 12' high system with poles and netting
- Posts are constructed of 2 3/8" D x 3/16" wall aluminum tubing
- Ground Sleeves are aluminum with rubber caps
- Top and Bottom of Net is supported by nylon coated galvanized cable
- 1 3/4" 3mm braided knotless EHT black net
- Posts are spaced 20' apart

BBS12A 12'H System - Complete **\$31<sup>99</sup>** FT ★ **S&H**  
 BBSNET12 12'H Replacement Net **\$12<sup>99</sup>** LF **S&H**

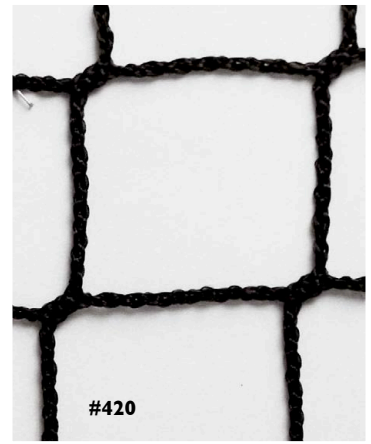

### PRE-CUT BOUNDARY/PROTECTIVE NETTING

- 1-3/4" mesh, weather treated Varsity (#420) EHT black knotless netting
- Heavy overlock stitched rope border

1236576 Net Size 10' x 30' **\$279<sup>99</sup>** EA ★  
 1236583 Net Size 12' x 50' **\$459<sup>99</sup>** EA ★  
 1236590 Net Size 14' x 50' **\$649<sup>99</sup>** EA ★  
 1236606 Net Size 14' x 100' **\$1,199<sup>99</sup>** EA ★



### PASS BACK TARGET

- 7'H x 4'W steel frame
- 4'H x 3'W rebound surface area
- Frame adjusts for varied rebound angles
- Add the STX Pass Master Cover and improve passing fundamentals and accuracy

1377188 1) BSN Frame and Solid Target **\$335<sup>99</sup>** EA ★  
 1371638 2) STX Pass Master Cover Only **\$50<sup>99</sup>** EA

**COACH'S CHOICE**



**INSTANT COLD PACK**

- Convenient and ready whenever you need it
- No refrigeration needed - activates instantly
- Ideal for sports injuries or first aid

**MU030102** 6" x 9" \$39.99 PACK



**REUSABLE HOT/COLD PACKS**

- Soft gel refrigerates for cold therapy and microwaves for heat therapy
- A versatile, non-toxic pack ideal for applying cold therapy or heat therapy

**MU030104** 4.75" x 6" \$44.99 PACK  
**MU030105** 6" x 9" \$49.99 PACK



**PERSONAL FIRST AID KIT**

- Plastic case with waterproof gasket
- Kit Contents: (10) 3/4" x 3" Adhesive Strips, (1) XL Adhesive Strip, (1), Fingertip Bandage, (1) Knuckle Bandage, (1) 2" Sterile Conforming Bandage, (2) 3" x 3" Gauze Pads, (2) Latex Gloves, (1) 1/2" x 5yd Adhesive Tape, (2) 1/32 oz. Triple Antibiotic, (2) 1/32 oz. First Aid Cream, (6) Antiseptic Towelette, (1) Instant Cold Pack, (1) Instant Sting Relief, (1) PAWS Antimicrobial Wipe



**1202090** 6.5" x 5" x 2" \$26.99 EA

**25 PERSON FIRST AID KIT**

- 9" x 6 5/16" x 2 3/8" Plastic Case with Waterproof Gasket and Wall Mount/Handle
- Kit Contents: (2) 1/2" x 5yd Adhesive Tape, (1) Instant Cold Pack, (10) Antiseptic Towelettes, (2 pair) Disposable Gloves, (10) 1/32 oz. First Aid Cream, (100) 1" x 3" Adhesive Strips, (1) 5" x 9" Combine Pad, (6) 3" x 3" Gauze Pads, (2) Oval Eye Pads, (1) Triangular Bandage, (1) 2" x 4yd Conforming Bandage, Scissors and Forceps



**1202106** OSHA Compliant \$44.99 EA

**50 PERSON FIRST AID KIT**

- 9" x 9" x 2 3/8" Plastic Case with Waterproof Gasket and Wall Mount/Handle
- Kit Contents: (2) 1/2" x 5yd Adhesive Tape, (2) Instant Cold Pack, (10) Antiseptic Towelettes, (2 pair) Disposable Gloves, (10) 1/32oz First Aid Cream, (8) Fingertip Bandages, (8) Knuckle Bandages, (2) Eye Wash Bottles, (100) 1" x 3" Adhesive Strips, (2) XL Adhesive Strips, (3) Insect Sting Relief, (1) 5" x 9" Combine Pad, (12) 2" x 2" Gauze Pads, (12) 3" x 3" Gauze Pads, (4) Oval Eye Pads, (2) Triangular Bandage, (2) 2" x 4yd. Conforming Bandage, (1) 4" x 2 yd. Conforming Bandage, (1) 3" Elastic Bandage, Scissors and Forceps



**1202113** OSHA Compliant \$74.99 EA



**MATT-KLEEN™ ALL PURPOSE DISINFECTANT CLEANER**

- Helps stop the spread of skin diseases and infections
- Ideal for wrestling and gymnastic mats, training tables and shower floors
- Highly concentrated; 2 oz. makes one full gallon



**1092479** Gallon \$99.99 EA



**WHIZZER®**

- Multipurpose concentrate kills HIV-1 (AIDS virus), MRSA, Hepatitis B & C, and other viruses. Kills strep, staph and fungus germs on contact.
- Cleaner, fungicide, mildewstat, virucide and deodorizer - all in one. Comes complete with 2 FREE Pint spray bottles.
- One ounce of concentrate mixed with water makes a gallon of full-strength disinfectant. 128 dilutions per gallon.
- Fast. Apply directly to mats, floors, walls, training tables, locker rooms, or personal items. Just wipe dry.



**30 Day Limited Warranty**  
**MU230201** 1 Gallon + 2 FREE Pint Spray Bottles \$94.99 CASE



**TUF-SKIN® COLORLESS SPRAY**

- Helps secure all tapes, underwrap and elastics to the skin in order to reduce friction and help prevent blisters and chafing
- Same formula as original Tuf-Skin® without the color; will not stain skin or clothes
- FAA regulations, can not ship via overnight air or 2nd day air.



**1078626** 10 oz. Can \$23.99 EA

**TREATMENT TABLE WITH BACK**

- Hardwood legs, laminated shelf and adjustable backrest
- Scratch resistant topcoat finish
- Fast and easy assembly
- Seamless rounded corners
- 2" firm foam padding
- Heavyweight, knit-backed upholstery
- 400lb capacity



**1453885** 78"L x 30"W x 31"H \$929.99 EA

**FLEX-I-WRAP**

- 4" wide plastic film on a roller makes wrapping a one-handed task
- Replaces elastic wraps at a fraction of the cost
- Provides compression while clear film allows inspection of injury
- Patented, built-in hand brake on roller makes tearing easy



**MDFLXWRP** 6 rolls w/ handle \$89.99 SET  
**1082562** Handle only \$17.99 EA  
**1082555** 6 rolls only \$77.99 EA

BSN SPORTS



### BSN SPORTS ATHLETIC TAPE

- 100% cotton backcloth, zinc oxide white trainer's tape
- High tensile strength with excellent tackiness
- 1 1/2" x 15 yard rolls

**MU130605B** 32 rolls per case \$94.99 CASE



### BSN SPORTS PRE-WRAP

- Pre-taping foam underwrap that protects athlete's skin from chafing and irritation
- Each roll is 2.75" x 30 yards long
- 48 rolls per case

**MU130597** \$84.99 CASE



### 750 ATHLETIC TAPE

- Zinc Oxide tape offers maximum tensile strength and comfortability
- Latex free adhesive
- Computer calibrated unwind for consistency and performance roll to roll
- Roll: 1.5" x 15 yd
- 32 rolls per case

**2190XXXX** Case of 32 \$124.99 PACK 32 ROLLS



### Mueller M-WRAP

- Pre-taping foam underwrap
  - Helps protect skin from tape chafing
  - Can be used to keep hair out of face, hold pads and socks in place and as a protective wrap inside athletic footwear
  - 48 rolls per case
  - Specify color
- Color Options: **Black, Blue, Gold, Green, Lime, Maroon, Natural, Navy, Orange, Pink, Purple, Red.**

**MU1307** 2.75" x 30 yards per roll \$74.99 CASE

- Red
- Blue
- Pink
- Green
- Orange
- Natural
- Lime
- Gold
- Purple
- Navy
- Black
- Maroon



### BANDAGE SCISSORS

- Flat-tipped bottom blade slips safely under tape and bandages
- Stainless steel, 7.25" blade

**1078695** \$27.99 EA



### Mueller M TAPE

#### M TAPE

- 100% cotton backcloth, zinc oxide white trainer's tape
- High tensile strength with excellent tackiness
- Easy unwind to core
- 1 1/2" x 15 yard rolls

**MU130105** 32 rolls per case \$129.99 CASE



### Johnson & Johnson 5188 ATHLETIC TAPE

- High-quality, breathable porous athletic tape protects joints from sprains and injury
- Provides support to speed recovery after injury
- Packaged in SPEED PACK®
- Each roll is 1 1/2" x 15 yds
- 32 rolls per case

**1420363** Case of 32 \$144.99 CASE



### Mueller TEAR-LIGHT TAPE

- Superior adhesive
- Excellent comfort
- Ideal for securing lateral knee braces as well as compression wrap or fixation bandages for padding and cold packs
- Available in 2" or 3" wide rolls

**MU130622** 2" x 5 yd - 24 rolls/case \$89.99 CASE  
**MU130623** 3" x 5 yd - 16 rolls/case \$89.99 CASE



### Mueller TAPE WRAP PREMIUM

- Excellent alternative to pre-wraps, compression wraps, wound care and fixation bandages.
  - Cohesive, breathable, sweat-resistant, high tensile, lightweight and easy tearing.
  - 2" x 6 yards is 24 rolls per case
  - 3" x 6 yards is 16 rolls per case
  - Specify color
- Color Options: **Black, White.**

**1348606** 2" - Specify Color \$69.99 EA  
**1348613** 3" - Specify Color \$84.99 EA



### SHARK TAPE CUTTER

- Cuts through tape and bandage material with ease.
- Made of the highest quality Valox resin, fiberglass-reinforced for durability.
- 8.25" L

**1082517** \$27.99 EA



**STANDARD SANITIZER STATION**

- Touchless, battery operated hand sanitizer 1200ml dispenser
- Drop tray catches extra sanitizer so floors remain clean
- Security lock to help prevent theft and vandalism, as well as an on/off bottom
- 4 C batteries or 6V, 1A adapter(not included)
- 22lb stand is hand-welded and finished with sleek black powder coat
- FREE Customization-Features 9" x 8" faceplate for custom messaging, design services included

**Color Options: Black, White.**

**1459264** 57"H x 13"W x 11.5"D **\$249<sup>99</sup>** EA



**ECONOMY SANITIZER STATION**

- Touchless, battery operated hand sanitizer 1200ml dispenser
- Drop tray catches extra sanitizer so floors remain clean
- Security lock to help prevent theft and vandalism, as well as an on/off bottom
- 4 C batteries or 6V, 1A adapter(not included)
- 12lb floor stand-Made of ABS plastic casing, which is chemical, heat and impact resistant

**Color Options: Black, White.**

**1459261** 45"H x 11.5"D x 13"W **\$149<sup>99</sup>** EA



**PREMIUM SANITIZER STATION**

- Touchless, battery operated hand sanitizer 1200ml dispenser
- Drop tray catches extra sanitizer so floors remain clean
- Security lock to help prevent theft and vandalism, as well as an on/off bottom
- 4 C batteries or 6V, 1A adapter(not included)
- 62lb stand is hand-welded and finished with sleek grey powder coat
- FREE Customization-Features 12" x 11" faceplate for custom messaging, design services included

**Color Options: Black, White.**

**1459267** 59"H x 16"W x 16"D **\$399<sup>99</sup>** EA

**WALL MOUNT DISPENSER**

- Touchless, battery operated hand sanitizer 1200ml dispenser
- Drop tray catches extra sanitizer so floors remain clean
- Security lock to help prevent theft and vandalism, as well as an on/off bottom
- 4 C batteries or 6V, 1A adapter(not included)

**Color Options: Black, White.**

**1459258** 10.75"H x 4.25"D x 5.75"W **\$59<sup>99</sup>** EA



**HAND SANITIZER**

- This product is FDA approved for consumer use and contains 80% v/v Ethanol and a approved moisturizer

**1459270** 1 gal Gel **\$59<sup>99</sup>** EA  
**1459271** 1 gal Liquid **\$59<sup>99</sup>** EA



# BRACES



## ATF3 ANKLE BRACE

- Next generation inner straps help protect against inversion sprains
- Single layer of comfortable fabric over the ankle bones
- Rigid plastic stays act like tendons to reinforce both sides
- Permanently bonded antimicrobial barrier
- Fits either foot

MU42370 Specify Size \$19<sup>99</sup> EA

	XS	SM	MD	LG	XL	XXL
U.S. MEN	6-7	7-9	9-11	11-13	13-15	15-17
U.S. WOMEN	7-8	8-10	10-12	12-14	14-16	16-18



## THE ONE ANKLE BRACE

- Comfortable in cleats or shoes during competition
- Very light and low profile
- Seamless construction under the foot
- Features anti slip criss-crossing side straps, side pulling stirrups, and cushioned tongue
- Fits either foot
- Color - black only

MU48800B Specify Size \$34<sup>99</sup> EA

### FITS STANDARD SIZE SHOE

	XXS	XS	SM	MD	LG	XL	XXL	XXXL
U.S. MEN	4-5	6-7	7-9	9-11	11-13	13-15	15-17	17-19
U.S. WOMEN	5-6	7-8	8-10	10-12	12-14	14-16	16-18	18-20



## T2 ACTIVE ANKLE

- Patented performance hinge which allows for virtually unlimited movement
- Feather-light EVA padding system hugs every contour of the ankle for an incredibly snug, comfortable fit
- Single strap adjusts for either high or low top shoes
- Small: 5-8.5 (M) 6.5-9.5 (W)
- Medium: 9-12 (M) 10-13 (W)
- Large: 12.5-16 (M) 13.5-16 (W)

1454546 Black - Specify Size \$57<sup>99</sup> EA  
1454550 White - Specify Size \$57<sup>99</sup> EA

	S	MD	LG
U.S. MEN	5-8	9-12	12-16



## JUMPERS KNEE STRAP

- Relieve patellar pain from frequent running and/or jumping
- helps improve patellar tracking by targeting pressure on the patella tendon, just below your kneecap
- Fits either knee - OSFA

MU52997 Black \$16<sup>99</sup> EA



## HINGED KNEE BRACE

- Extremely comfortable fabric with maximum medial-lateral support to help protect weak or injured knees
- Mueller-exclusive HydraCinn<sup>®</sup> fabric, Triaxial Hinges, Tibial containment system
- Inner anti-slip strips, flatlock seams
- Form-fitting hourglass design, fully adjustable and comfortable fit

Size: **SML, MED, LRG, XLG, 2XL.**

MU54011 Specify Size \$69<sup>99</sup> EACH

XS	SM	MD	LG	XL	XXL
10"-12"	12"-14"	14"-16"	16"-18"	18"-20"	20"-22"

### MEASURE AROUND KNEE



## PRO LEVEL HINGED KNEE BRACE

- Extended length provides better fit and comfort
- Seam-sealed anatomically correct patellar cut-out with gel
- Lower profile 360 degree straps with enhanced nubuck fastener tabs
- Patented, heavy-duty triaxial hinges
- Latex free with snag resistant bindings

MU5301 Sizes: SM-3XL \$82<sup>99</sup> EA

	7 in below center of knee	7 in below center of knee
SM	18-19 in (46-48 cm)	13-14 in (31-34 cm)
MD	19-20 in (48-50 cm)	14-15 in (35-38 cm)
LG	21-22 in (53-55 cm)	15-16 in (38-40 cm)
XL	23-24 in (58-60 cm)	16-17 in (40-43 cm)
2XL	25-26 in (63-66 cm)	17-18 in (43-45 cm)

If measurements indicate different sizes, choose the larger size.



## KT TAPE

- Provides support to muscles and joints
  - Wave pattern adhesive that moves with your skin
  - Apply it to skin in patterns to mimic your muscles
- Color Options: **Black, Blue, Pink, Beige.**

MU28147 Specify Color \$69<sup>99</sup> ROLL



## PORTABLE FLOOR SCALE

- Low profile design, heavy duty mechanical construction and a non-skid vinyl mat
- The large diameter dial allows for easy readability even for tall people
- Designed for personal use, fitness centers, and health care facilities
- 300 lb. capacity
- Overall dimensions: 2.5"H x 12"W x 16.75"D - 9 lbs.
- Platform dimensions: 11.25"W x 11.75"D

**2 Year Limited Warranty**

1292725 D1130 \$124<sup>99</sup> EA

## PHYSICIAN'S SCALE

- Features a height rod in inches and centimeters, from 30" to 78" (76cm to 198cm).
- Platform cover is easily removed for cleaning.
- Die-cast beam can be easily read from either side.
- 400 lb. capacity.
- Heavy duty understructure.
- Every Detecto physician scale features a time-honored reputation for rigid construction and precision engineering.

**2 Year Limited Warranty**

1077858 #439 \$399<sup>99</sup> EA



# SELECT



NFHS APPROVED

## NUMERO 10

- New golf ball structured surface for pure flight
- Great quality match ball.
- NFHS/NCAA approved, 32-panel hand-sewn
- Color Options: White/Black, Yellow/Blue, White/Blue, White w/ Red/Purple

**1461141** Size 5-White \$58<sup>99</sup> EA  
**1461791** Specify Color/Size \$58<sup>99</sup> EA



NFHS APPROVED

## NEW! THOR

- 1.0 mm PU cover with zero wing latex bladder
- Hand-sewn ball
- NFHS/NCAA approved

**1461142** Size 5-White w/ Blue/Silver \$43<sup>99</sup> EA



## NEW! CLUB DB

- Dual bonded 3mm textured panels
- Seams are stitched and heat sealed for less water uptake
- Ideal training ball for all levels. SR bladder for longer air retention

**1461143** Size 5 - White w/ Black \$34<sup>99</sup> EA

## NEW!

### ROYALE

- 1.7mm PU cover with zero wing bladder
- NFHS/NCAA approved
- Hand-sewn
- Color Options: White/Blue, Red/Purple, Green/White/Blue-Size 4

**1461140** Size 5-White/Black/Gold \$75<sup>99</sup> EA  
**1461786** Specify Color/Size \$75<sup>99</sup> EA



NFHS APPROVED

### CLASSIC

- Premium camp and rec ball for grass
- Newly developed PVC-composite
- Butyl bladder for better air retention
- Sz. 3 Orange; Sz. 4- Yellow; Sz. 5 - White

**1456061** Specify Size/Color \$24<sup>99</sup> EA



NFHS APPROVED



### BRINE PHANTOM X

- Ultra abrasion-resistant PU cover with texture
- High Retention Latex bladder system
- Hand-stitched
- Optimal for training or match-level play
- 2 Year Limited Warranty**

**1397721** Size 5 - Specify Color \$56<sup>99</sup> EA



### BRINE ATTACK

- Highly durable PVC cover
- Butyl bladder
- Hand stitched
- Color Options: **Black, Royal**

**1378536** Size 5 - Specify Color \$24<sup>99</sup> EA



NFHS APPROVED



### BRINE VORACITY

- Soft PU cover
- Hand stitched
- High Retention Latex bladder system
- 2 Year Limited Warranty**
- Color Options: **Black.**

**1378532** Size 5 - Black \$45<sup>99</sup> EA



NFHS APPROVED



### BRINE CHAMPIONSHIP II

- Premium high-performance glossy PU cover
- High Air Retention Latex Bladder
- Hand-stitched
- Optimal for match-level play
- 2 Year Limited Warranty**

**1395098** Size 5 - White/Black \$89<sup>99</sup> EA





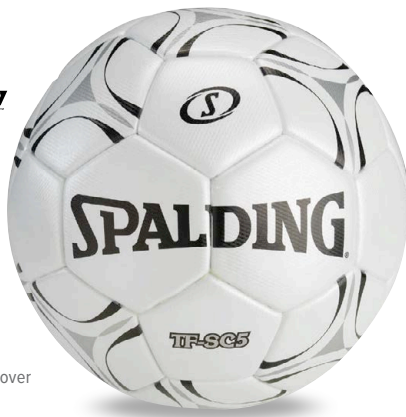

### SPALDING TF-SC5

- Pro Game Ball - Thermal bonding panel technology
- Top grade performance composite cover
- Premium cushion foam backing
- Cloth-reinforced bladder
- NFHS approved

**WC648678** Size 5 \$89<sup>99</sup> EA



### SPALDING TF-5000

- Competition Game Ball - Hand Stitched
- Tournament Composite Cover
- Latex rubber bladder
- NFHS approved

**WC647929** Size 5 - Black/White \$69<sup>99</sup> EA



### THERMO

- The Thermo ball provides a seamless transition from practice to a game ball
- Same Thermal bonded construction as The Perfection
- More affordable ball for game or practice
- NFHS Approved



**1460267** Size 5 \$49<sup>99</sup> EA



### CLUB ELITE TEAM

- Synthetic leather with Aerowtrac grooves for superior flight
- Modern fuse technology for enhanced touch and feel

Color Options: **100 - WH/BK/SI**  
Size: **5.**



**NKCU8057** Size 5 \$60<sup>00</sup> EA



### PERFECTION THERMO

- The Perfection Thermo is a match level thermal bonded soccer ball
- Panels are sealed together to minimize water absorption to avoid misshaped water logged balls.
- NFHS Approved



**1460266** Size 5 \$109<sup>99</sup> EA



**NEW!**



### VEZA

- Unique 20-panel design optimizes geometric striking zones for controlled, precise strikes
- Textured cover offers durability and performance
- Advanced carcass and bladder construction provides durable and balanced round shape
- NFHS approved



**WLWS1001001XB05** Size 5 \$69<sup>99</sup> EA

**NEW!**



### NCAA VANQUISH MATCH

- A textured cover offers great touch with a 20-panel fused construction, to keep moisture out and extend durability
- Improved ball tracking, high visibility, tech graphics with color accents allowing the player to easily track the ball
- NFHS approved for Size 5

Color Options: **White**

Size: **4, 5.**



**WLWS100110** Size 4, 5 \$39<sup>99</sup> EA



**NEW!**



### NCAA VIVIDO MATCH

- Unique 20-panel design optimizes geometric striking zones
- VST (Visual Spin Technology) uses color variance for easier spin detection and ball tracking
- Advanced construction and a high performance foam lining generate higher energy return upon impact
- NFHS, NCAA and FIFA approved

Color Options: **White, Yellow**

Size: **5.**



**WLWS100090** Size 5-Specify Color \$110<sup>99</sup> EA

# SELECT PACKS



## Brilliant Super HSB V22 NFHS - 6 Pack

- New cutting edge design that improves the best ball in the world
- Teijin microfiber PU cover with 3 layer underlining
- Patented zero wing latex bladder with diamond ball textured surface
- 32 hand crafted panels that ensures true flight
- Underlying foam gives a light touch with comfortable softness
- NFHS/NCAA approved
- Color: White w/blue/black - includes ball bag
- 3 Year Limited Warranty

1461799 Size 5 \$764.99 pack



## Royale V22 - 10 Pack

- NFHS/NCAA approved-hand stitched
- 1.7 mm textured PU cover with zero wing latex bladder
- One of Select's all time best selling match balls
- Includes ball bag
- Color options: white w/red, white w/blue, white w/green
- 3 Year Limited Warranty

1461755 Size 5-Specify Color \$599.99 pack



## Numero 10 V22 - 10 Pack

- Select's legendary best selling match ball
- New Diamond textured hand stitched panels
- 1.5 mm PU cover with zero wing latex bladder
- Color options: white w/blue, yellow w/yellow/blue, white w/black/gold, white w/green/orange
- Includes ball bag
- Size 4 in white w/black/gold, yellow w/yellow/blue
- 2 year warranty

1461760 Size 5-Specify Color \$499.99 pack



## Viking DB V22 - 10 Pack

- Great match and practice ball for all levels
- NFHS/NCAA approved, SR bladder that provides high air retention
- 1.1 mm PU cover with zero wing bladder
- Duel Bonded - panels stitched and glued for less water uptake
- Color: White w/red/green, White w/blue/green
- Includes ball bag
- 2 year limited warranty

1461770 Size 5 \$428.99 pack



## Thor - 10 Pack

- Top selling match and practice ball
- NFHS/NCAA approved-hand stitched
- 1.0 mm PU cover with 7-wing latex bladder
- Color: white w/blue/silver
- Top value for tight budgets
- White w/blue/Silver - includes ball bag
- 2 year limited warranty

1461801 Size 5 \$348.99 pack



## Diamond V22 - 10 Pack

- Top class match/practice ball for all levels. Durable and strong
- Butyl bladder for long air retention.
- Made with TPU film with lamination of 2mm TPE foam
- Hand stitched, 32 panel ensures true flight.
- Size 4.5 - White w/blue/red
- Includes ball bag
- 2 Year Limited Warranty

1461773 Specify Size 4,5 \$348.99 pack



## Club DB V22 - 10 Pack

- The best practice ball just got better
- Dual Bonded, stitched and bonded for less water uptake
- Textured 3mm TPU cover laminated with foam for softness
- SR bladder for longer air retention
- White w/blue/yellow (size 3,4,5) White w/red/yellow (size 5)
- Orange/w/blue/yellow (size 4,5) White w/green/yellow (size 5) All White (size 3,4,5)
- Includes ball bag
- 1 year limited warranty

1461776 Specify Size/Color \$299.99 pack



## Turf - 24 Pack

- New TURF NFHS approved ball
- 1 mm grain textured PU cover for hard surfaces and turf
- Butyl bladder for great air retention
- Color: Yellow w/orange/black
- Sizes 4,5 - Includes two ball bag
- 1 year stitching warranty

1457208 Size 5 \$699.99 pack



## Blaze DB - 10 Pack

- Dual Bonded - hand stitched
- Seams are sealed with heat activated glue for less moisture uptake
- PU lightly textured laminated panels with 3.5 mm thick foam
- Utilizing a SR bladder for excellent air retention
- Includes ball bag
- Size 5 - White w/blue/red

1461800 Size 5 \$588.99 pack



## Classic - 10 Pack

- Premium camp or recreational ball.
- Newly developed PVC-composite with improved softness
- Butyl bladder for long air retention.
- Includes ball bag
- Size 3,4,5 - Color: yellow

1456064 Specify Size \$224.99 pack



## Over-Vest Training Bib - Set of 12/Color

- Comfortable and cost efficient
- 100% poly mesh
- Horizontal panel convenient for logo screening
- Color options: pink, green, red, orange, blue, yellow
- Size junior, senior

1456068 Specify Color/Size \$99.99 DZN



## Futsal Magico - 6 Pack

- PU surface for optimal durability
- Low bounce for perfect control
- Hand stitched 32 panel for perfect flight
- Butyl bladder for longer air retention
- Includes ball bag -size jr, sr
- 1 year limited warranty

1454113 Specify Size \$189.99 pack

# RUBBER/SYNTHETIC



## MacGregor MATCH 32

- Quality laminated PU cover
- Butyl bladder for maximum air retention
- Foam backing for improved feel
- NFHS approved



1390104

Size 5

\$36.99 EA ★



## Voit RUBBER BALL

- Waterproof for fun outdoor play

Size: 3, 4, 5.

VCS33XXX

Specify Size

\$17.99 EA ★



## MacGregor CLASSIC 32

- Long lasting, sewn synthetic cover
- 32 panel ball with butyl bladder
- 2-ply backing

Size: 3, 4, 5.

MCS30005

Specify Size

\$19.99 EA ★



## SELECT FUTSAL JINGA

- Synthetic leather
- Low bounce for easy control
- Hand sewn 32-panel construction

Size: Junior, Senior

Color Options: White/Blue, Yellow/Blue.

1453626

Specify Size/Color

\$48.99 EA

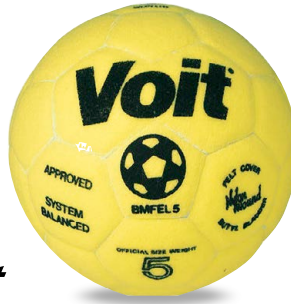

## Voit INDOOR FELT

- Nylon wound, molded felt cover
- Soft kick feel for virtually painless play

Size: 4, 5.

VSBMFEL5

Specify Size

\$29.99 EA ★



## MacGregor LIMITED

- PVC soft cover
- Machine stitched

1262698

Senior Size

\$26.99 EA ★



## MacGregor RUBBER BALL

- Best value playground soccer ball anywhere
- Extended-life molded construction

Size: 3, 4, 5.

MCSBR5XX

Specify Size

\$15.99 EA ★

### YMCA HERITAGE

- Soft PVC cover
- Machine stitched

1384325	Size 5 - Silver	\$19.99 EA ★
1384326	Size 4 - Black	\$19.99 EA ★
1384327	Size 3 - Red	\$19.99 EA ★

## MacGregor MERCURY CLUB

- Soft PVC cover
- Machine stitched
- Butyl bladder

70200235

Size 5 - Silver/Black/Orange

\$24.99 EA ★

70200234

Size 4 - Silver/Black/Green

\$24.99 EA ★

70200233

Size 3 - Silver/Black/Blue

\$24.99 EA ★



## HEX NETS

## SOCCER NETS

## SQUARE MESH

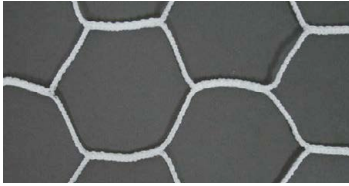

ORANGE



WHITE

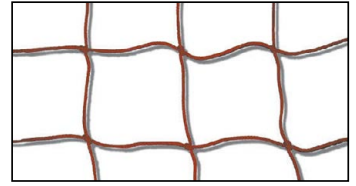

CODE	SIZE	BODY	RECOMMENDED USE	COLOR	PRICE
<b>SN383PROY</b>	8'H x 24'W x 5'D x 10'B	5.0 mm braided PE	College & Pro	Orange	<b>\$389<sup>99</sup> PR ★</b>
<b>SN383PROW</b>	8'H x 24'W x 5'D x 10'B	5.0 mm braided PE	College & Pro	White	<b>\$389<sup>99</sup> PR ★</b>
<b>1248876</b>	8'H x 24'W x 4.5'D x 10'B	4.0 mm braided PE-Hexagonal	College & Pro	Black/White	<b>\$379<sup>99</sup> PR ★</b>
<b>1397773</b>	8'H x 24'W x 3'D x 8.5'B	4.0 mm braided PE-Hexagonal	College & Pro	Black/White	<b>\$369<sup>99</sup> PR ★</b>
<b>1367770</b>	8'H x 24'W x 3'D x 5'B	4.0 mm braided PE-Hexagonal	College & Pro	Black/White	<b>\$329<sup>99</sup> PR ★</b>
<b>1367769</b>	8'H x 24'W x 3'D x 8.5'B	4.0 mm twisted knotted PE	College & Pro	White	<b>\$334<sup>99</sup> PR ★</b>
<b>1367768</b>	7'H x 21'W x 3'D x 7.5'B	4.0 mm twisted knotted PE	Club/Recreational	White	<b>\$269<sup>99</sup> PR ★</b>
<b>1367767</b>	6.5'H x 18.5'W x 2'D x 7'B	4.0 mm twisted knotted PE	Club/Recreational	White	<b>\$249<sup>99</sup> PR ★</b>
<b>1367766</b>	6.5'H x 12'W x 2'D x 7'B	4.0 mm twisted knotted PE	Club/Recreational	White	<b>\$209<sup>99</sup> PR ★</b>
<b>1054729</b>	8'H x 24'W x 4'D x 8'B	3.0 mm twisted knotted PE	High School/Club	White	<b>\$312<sup>99</sup> PR ★</b>
<b>1054678</b>	7'H x 21'W x 4'D x 8'B	3.0 mm twisted knotted PE	Club/Recreational	White	<b>\$249<sup>99</sup> PR ★</b>
<b>1054682</b>	6.5'H x 18.5'W x 3'D x 6'B	3.0 mm twisted knotted PE	Club/Recreational	White	<b>\$229<sup>99</sup> PR ★</b>
<b>1054699</b>	6.5'H x 12'W x 3'D x 6'B	3.0 mm twisted knotted PE	Club/Recreational	White	<b>\$199<sup>99</sup> PR ★</b>
<b>1367772</b>	4.5'H x 9'W x 2'D x 4.5'B	3.0 mm twisted knotted PE	Club/Recreational	White	<b>\$179<sup>99</sup> PR ★</b>
<b>1367771</b>	4'H x 6'W x 2'D x 4'B	3.0 mm twisted knotted PE	Club/Recreational	White	<b>\$169<sup>99</sup> PR ★</b>
<b>SN383SNRY</b>	8'H x 24'W x 5'D x 10'B	3.0 mm twisted PE	High School/Club	Orange	<b>\$189<sup>99</sup> PR ★</b>
<b>SN383SNRW</b>	8'H x 24'W x 5'D x 10'B	3.0 mm twisted PE	High School/Club	White	<b>\$189<sup>99</sup> PR ★</b>
<b>1033526</b>	8'H x 24'W x 5'D x 10'B	2.5 mm twisted PE	Recreational	Orange	<b>\$159<sup>99</sup> PR ★</b>
<b>SN383ECOW</b>	8'H x 24'W x 5'D x 10'B	2.5 mm twisted PE	Recreational	White	<b>\$159<sup>99</sup> PR ★</b>



### SAND BAGS

- Holds 50 lbs. of sand (not included)
- Heavy duty pvc handle for easy carrying
- Zipper closure

**1336542** 22" x 15" **\$99<sup>99</sup>** SET OF 4 ★



### TWIST-IN NET HOOKS

- Color: White

**STNTCLIP** **\$1.99<sup>99</sup>** EA ★  
**STNETCLP** **\$59<sup>99</sup>** 50/SET ★



### HOOK & LOOP NET STRAPS

- 16" straps for 3" diameter and larger items
- 11" straps for 2" diameter and smaller items

**1033502** White - 16" **\$59<sup>99</sup>** SET OF 24 ★  
**1368869** White - 11" **\$47<sup>99</sup>** SET OF 24 ★



### SCREW-IN NET HOOKS

- Set of 50

**MSBNETHK** **\$34<sup>99</sup>** SET OF 50 ★



### FLIP OVER WHEEL KIT

- NO-FLAT wheels attach to any backstay up to 2" O.D.
- Compatible with all Alumagoal soccer goals (SGA400, SGA401, SGA402, SGA403 and all 3" Round Classic Club goals)
- Sold in sets of (2) wheels
- Two sets are required for a pair of goals

**SCGWHLXX** **\$269<sup>99</sup>** SET OF 2 ★

### PERMANENT GROUND ANCHORS

- 12" long; 2" O.D galvanized steel
- 4 anchors per goal required

**ZTSPANCHX**



**\$139<sup>99</sup>** SET ★

### AUGER STYLE GROUND ANCHOR

- 12" long; 12 mm O.D. galvanized steel rod
- 4 anchors per goal required

**SGAUGER**



**\$36<sup>99</sup>** EA ★



### SPIKE WITH CABLE LANYARD

- 14" galvanized spike
- 4 per goal required

**SGSPIKE**

**\$36<sup>99</sup>** EA ★



**FREE NETS & GROUND ANCHORS INCLUDED**

# ALUMAGOAL®

## 4" ROUND CLASSIC GOALS

- Official size 8'H x 24'W x 3'D x 9'B
- Meets NCAA, NFSHA and FIFA specs
- Front face is 4" round, powder coated custom aluminum extrusion for superior strength
- Backstays are 2" round powder coated aluminum
- Rear crossbars are 2" round galvanized steel
- Built-in net clip track with clips
- Includes 4mm white nets and ground anchors
- 360 lbs./pr



**SGA400**  
**SCGWHLXX**  
**1367769**

Complete Unit  
Flip Over Wheel Kit - 1 Pr/Set  
4mm - Replacement Net

**\$5,499<sup>99</sup>** PR ★ **S&H**  
**\$269<sup>99</sup>** SET ★  
**\$334<sup>99</sup>** PR ★



**GROUND ANCHOR ATTACHMENT**



**\* WHEEL KIT CAN BE ADDED**



**ROUND DESIGN SHOWING NET CLIP TRACK**



# ALUMAGOAL®

## FOOTBALL/SOCCER COMBO GOAL

- Meets High School soccer and football regulations
- 10'H football uprights are constructed of 2" square aluminum tubing
- Width of uprights can be adjusted for H.S. (23'4") or Collegiate (18'6") play or removed for soccer play
- Soccer goal size - 8'H x 24'W x 3'D
- Soccer post are constructed of 11 gauge 2" x 4" steel tubing
- Crossbars are constructed of 14 gauge 2" x 4" steel tubing
- Two-piece engineered crossbar for increased ease of shipping and installation

- Euro style backstays are constructed of 14 gauge - 1.5" steel tubing
- Extremely corrosion resistant galvanized and white powder coated finish
- Goals include backstays, 4mm soccer nets, net fasteners and ground stakes
- Optional Ground Sleeves available for semi-permanent installation

**5 Year Limited Warranty**

**SGFBCOM**  
**1367769**  
**1308082**

1 Pair of Goals - Includes Nets  
4mm - Replacement Net  
Ground Sleeves - 4/Set

**\$4,499<sup>99</sup>** PR ★ **S&H**  
**\$334<sup>99</sup>** PR ★  
**\$229<sup>99</sup>** SET ★



# ALUMGOAL<sup>®</sup>



**NATURAL ALUMINUM  
FREE NETS & GROUND ANCHORS INCLUDED**



**HEAVY WALL BOTTOM BAR  
ON 12', 18.5', 21' AND 24' MODELS**



**NET CLIP TRACK IN TOP  
& SIDE FRAMES**



### SOCCER GOAL SAFETY PADDING

- Meets NFSHSA rule regarding safety padding
- Fits 2" x 4", 4" x 4" and 3" x 4" round soccer goals
- High density 1" thick foam covered in white vinyl coated nylon
- Hook & loop fasteners attached
- 1 pair per goal

1089363DS

72"H

\$534<sup>99</sup> PR

## 3" ROUND CLASSIC CLUB GOALS

- Front face is 3" round custom aluminum extrusion
  - Built in net clip track
  - Backstays are 2" round heavy wall aluminum tubing
  - Double reinforced Tig welded corners
  - Stainless steel hardware
  - Includes 4mm White Net, Net Clips and Ground Anchors
  - Includes Back Bottom Bar (24', 21', 18.5' & 12' models only)
  - Meets NFSHSA specs (8' x 24' SGA300 model only)
- 5 Year Limited Warranty**



### NATURAL ALUMINUM 3" ROUND CLUB GOALS

<b>SGA320</b>	8'H x 24'W x 3'D x 8.5'B – 330 lbs./pr.	<b>\$3,999<sup>99</sup></b> PR ★
<b>SGA321</b>	7'H x 21'W x 3'D x 7.5'B – 301 lbs./pr.	<b>\$3,699<sup>99</sup></b> PR ★
<b>SGA322</b>	6.5'H x 18.5'W x 2'D x 7'B – 260 lbs./pr.	<b>\$3,499<sup>99</sup></b> PR ★
<b>SGA323</b>	6.5'H x 12'W x 2'D x 7'B – 208 lbs./pr.	<b>\$3,099<sup>99</sup></b> PR ★
<b>SGA324</b>	4.5'H x 9'W x 2'D x 4.5'B – 134 lbs./pr.	<b>\$2,599<sup>99</sup></b> PR ★
<b>SGA325</b>	4'H x 6'W x 2'D x 4'B – 118 lbs./pr.	<b>\$2,399<sup>99</sup></b> PR ★



# ALUMAGOAL®



**WHITE POWDER-COATED  
FREE NETS & GROUND ANCHORS INCLUDED**



## 3" ROUND CLASSIC CLUB GOALS

- Front face is 3" round custom aluminum extrusion
  - Built in net clip track
  - Backstays are 2" round heavy wall aluminum tubing
  - Double reinforced Tig welded corners
  - Stainless steel hardware
  - Includes 4mm White Net, Net Clips and Ground Anchors
  - Includes Back Bottom Bar (24', 21', 18.5' & 12' models only)
  - Meets NFSHA specs (8' x 24' SGA300 model only)
- 5 Year Limited Warranty**



## POWDER-COATED WHITE 3" ROUND CLUB GOALS

<b>SGA300</b>	8'H x 24'W x 3'D x 8.5'B - 330 lbs./pr	\$4,599 <sup>99</sup> PR ★
<b>SGA301</b>	7'H x 21'W x 3'D x 7.5'B - 301 lbs./pr.	\$4,299 <sup>99</sup> PR ★
<b>SGA302</b>	6.5'H x 18.5'W x 2'D x 7'B - 260 lbs./pr.	\$3,999 <sup>99</sup> PR ★
<b>SGA303</b>	6.5'H x 12'W x 2'D x 7'B - 208 lbs./pr.	\$3,599 <sup>99</sup> PR ★
<b>SGA304</b>	4.5'H x 9'W x 2'D x 4.5'B - 134 lbs./pr.	\$2,999 <sup>99</sup> PR ★
<b>SGA305</b>	4'H x 6'W x 2'D x 4'B - 118 lbs./pr.	\$2,799 <sup>99</sup> PR ★



**HEAVY WALL BOTTOM BAR  
ON 12', 18.5', 21' AND 24' MODELS**



**NET CLIP TRACK IN TOP  
& SIDE FRAMES**



**GROUND ANCHORS AND NET CLIPS INCLUDED!**



# ALUMAGOAL®



## 4" EURO ALUMAGOAL

- Official size 8'H x 24'W x 3'D x 9'B
- Meets NCAA, NFSHSA and FIFA specs
- Crossbars and posts are 4" round, powder coated custom aluminum extrusion for superior strength
- European backstays are 2" round powder coated aluminum

- Double reinforced tig welded corners
- Built-in net clip track with clips
- Stainless steel hardware
- Includes full depth 4mm white nets and sand bag anchors
- 386 lbs. Per Pair

**\$7,499<sup>99</sup>**

SGA401 ★ Complete Unit 

1367769 ★ Replacement Net **\$334<sup>99</sup>**

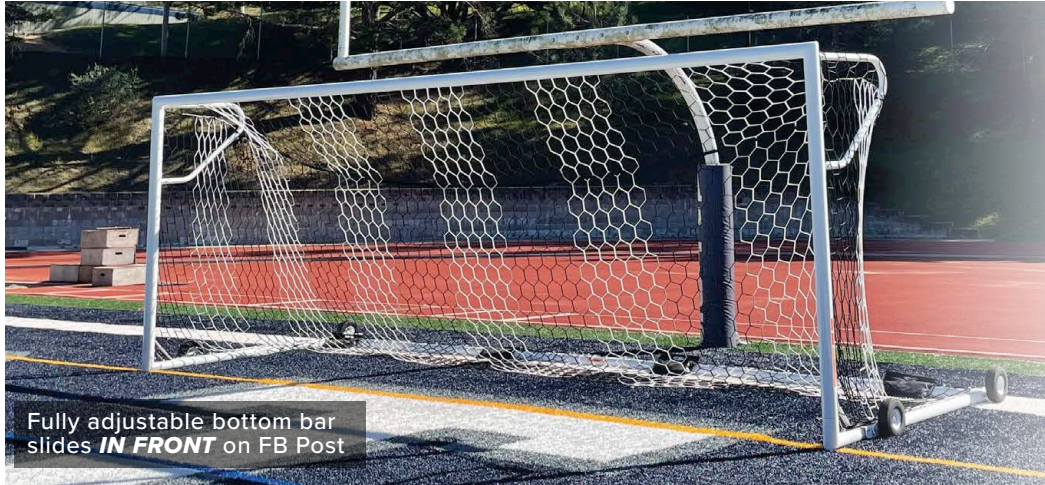

Fully adjustable bottom bar slides **IN FRONT** on FB Post

## 4" EURO STADIUM ALUMAGOAL

- Official size 8'H x 24'W x 3'D x 9'B
- Meets NCAA, NFSHSA and FIFA specs
- Meets Safety & Performance Specification ASTM F2950-14
- Crossbars and posts are 4" round, powder coated custom aluminum extrusion for superior strength
- European backstays are 2" round powder coated aluminum
- Double reinforced tig welded corners
- Built-in net clip track with clips
- Stainless steel hardware
- Includes 4mm Black/White, half depth hexagonal nets and sand bag anchors and n-flat transport wheels
- Fully adjustable bottom bar that fits in front of Football Goal Post
- 450lbs. Per Pair



5 Year Limited Warranty

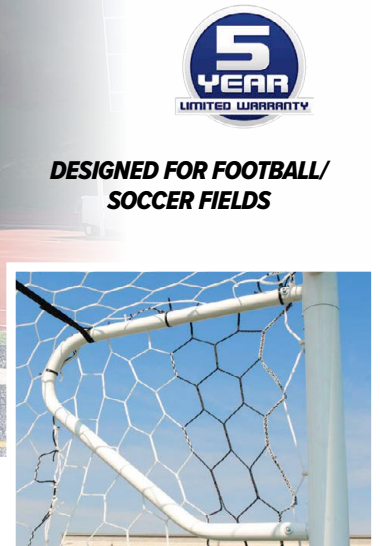

**DESIGNED FOR FOOTBALL/  
SOCCER FIELDS**

**\$7,899<sup>99</sup>**

SGA403 ★ Complete Unit 

1367770 ★ Replacement Net **\$329<sup>99</sup>**



# ALUMAGOAL®



## MANCHESTER MATCH GOAL

- Official size 8'H x 24'W x 3'D x 9'B
- Meets NCAA, NFSHSA and FIFA specs
- Crossbars and posts are 4" round, powder coated custom aluminum extrusion for superior strength
- Backstays are 2" round powder coated aluminum
- Double reinforced tig welded corners
- Built-in net clip track with clips
- Stainless steel hardware
- Includes 4mm Black/White hexagonal nets, sand bag anchors and transport wheels
- 480 lbs. Per Pair

**\$8,799<sup>99</sup>**

SGA402 ★ Complete Unit 

1397773 ★ Replacement Net **\$369<sup>99</sup>**



**FEATURES:  
NET CLIP TRACK IN TOP,  
SIDE AND BOTTOM FRAMES**



**NET CLIPS INCLUDED  
FAST SETUP & TAKEDOWN**



**ROUND DESIGN  
SHOWING NET CLIP TRACK**



**FLIP-OVER WHEELS FOR EASY TRANSPORT!**

## ALL PURPOSE BACKSTOP SYSTEM

- Backstop system measures 21'H x 65'W
- Constructed with (4ea) 3.5" galvanized 11 guage steel poles
- Choice of 3mm 4" mesh or 1.75" mesh (275 lb. breaking strength)
- Easy on and off pulley system and (4ea) galvanized steel ground sleeves
- Weight: 360 lbs.

<b>1071436</b>	System with 4" Netting	\$4,799 <sup>99</sup> EA ★	<b>SeH</b>
<b>1071435</b>	System with 1 3/4" Netting	\$4,699 <sup>99</sup> EA ★	<b>SeH</b>
<b>1249071</b>	Replacement Net - 4" Mesh	\$459 <sup>99</sup> EA ★	
<b>1072230</b>	Replacement Net - 1 3/4" Mesh	\$899 <sup>99</sup> EA	

## BALL BOUNDARY SYSTEM

- Complete 12' high system with poles and netting
- Posts are constructed of 2 3/8"D x 3/16" wall aluminum tubing
- Ground Sleeves are aluminum with rubber caps
- Top and Bottom of Net is supported by nylon coated galvanized cable
- 1 3/4" 3mm braided knotless EHT black net
- Posts are spaced 20' apart
- Please allow 3 - 4 weeks for delivery

<b>BBS12A</b>	12'H System - Complete	\$31 <sup>99</sup> FT ★	<b>SeH</b>
<b>BBSNET12</b>	12'H Replacement Net	\$12 <sup>99</sup> LF	<b>SeH</b>



## OFFICIAL COMPETITION FUTSAL GOAL

- Full aluminum construction
- White powder coated goal face with built-in net clip track
- Includes 4mm white net and non marring floor protectors

<b>FGA500</b>	7'H x 9'10"W x 2'8"D x 3'4"B - 185 lbs/pr	\$3,299 <sup>99</sup> PR ★	<b>SeH</b>
<b>1273489</b>	Replacement Net - 4mm	\$199 <sup>99</sup> PR ★	



## PORTABLE/FOLDABLE INDOOR SOCCER GOAL

- Goal measures 6.5'H x 12'W x 5'D
- 2" square steel powder coated face
- Both backstays fold inward for storage
- Non-marking floor pads are on each of the 4 contact points
- 3mm white net
- Weight: 174 lbs. per pair

<b>SCGOAL5A</b>	2 Goals with Nets	\$1,499 <sup>99</sup> PR ★	<b>SeH</b>
<b>SCGOAL5B</b>	1 Goal with Net	\$799 <sup>99</sup> EA ★	<b>SeH</b>
<b>SCNET6DS</b>	Replacement Net	\$149 <sup>99</sup> EA ★	





**MacGregor**  
**PLASTIC SHIN GUARDS**

- Practical shin guards with plastic foam backing

<b>MCS67WHS</b>	Youth - 7"	\$7 <sup>99</sup> PR ★
<b>MCS69WHS</b>	Adult - 9"	\$9 <sup>99</sup> PR ★



**MacGregor**  
**PADDED SHIN GUARDS**

- Stirrup design for ankle and shin protection
- Adjustable hook/loop strap

<b>1276534</b>	Youth - 7"	\$25 <sup>99</sup> PR ★
<b>1276541</b>	Adult - 9"	\$26 <sup>99</sup> PR ★



**GOALIE GLOVES - ADULT**

- White latex foam palm for grip and durability
  - Gusseted fingers for comfort and ball control
  - Hook-and-loop closure
- Size: **8, 9, 7, 10.**

<b>MCS6LVA</b>	Adult: 7-10	\$33 <sup>99</sup> PR ★
----------------	-------------	-------------------------



**GOALIE GLOVES - YOUTH**

- White latex foam palm for grip and durability
  - Gusseted fingers for comfort and ball control
  - Hook-and-loop closure
- Size: **4, 5, 6.**

<b>MCS6LVY</b>	Youth: 4-6	\$31 <sup>99</sup> PR ★
----------------	------------	-------------------------



**33 PROTEC HG**

- Hyla Cut 3mm heat treated Dura Grip latex for added durability on artificial turf surfaces
  - Fixed guards for protection of the fingers
  - NEW slit like wrist closure with velcro for easy on/off
- Size: **7, 8, 9, 10, 11.**

<b>1461119</b>	Specify Size	\$39 <sup>99</sup> PR
----------------	--------------	-----------------------



**77 SUPER GRIP**

- 4 mm super soft latex for a perfect grip
  - Latex on fingertips for stability and impact protection
  - Removable finger protection
  - Anatomical FIT System to ensure correct fit
- Size: **7, 8, 9, 10, 11.**

<b>1461125</b>	Specify Size	\$54 <sup>99</sup> PR
----------------	--------------	-----------------------



**WEIGHTED BASES AND WHEELS**

**SOCCER INNOVATIONS**

**SOCCER WALL TURF-SINGLE**

- Lightweight and wind resistant
- Body design deflects balls keeping the mannequin upright
- Can be used on all surfaces
- Convert your Soccer Wall Turf to grass by adding a ground spike
- Sand Bag included

Color Options: **Neon Green/Blue, Black/Green, Red/Blue, Yellow/Blue.**

**1460517** Specify Color **\$199<sup>99</sup>** EA



**PORTABLE BARRIER NET**

- Multi-sport portable barrier net
- Sets up in minutes
- Includes free carry bag with wheels

**1344097** 12' 6"H x 21' 6"W - 56 lbs. **\$589<sup>99</sup>** EA

**TRAINER / REBOUNDER GOAL**

- Net can be adjusted for rebound, used for shooting skills, finishing skills or splitting one field into two
- Made of 1 7/8" diameter heavy wall aluminum tubing
- Spring button assembly requires no tools
- 30" steel anchoring shoes with permanent spikes
- 3mm 4" polyethylene net and carrying bag

**1150858** 7'H x 21'W **\$929<sup>99</sup>** EA ★ **S&H**  
**1076127** Replacement Net **\$129<sup>99</sup>** EA ★  
**1366835** Optional All Surface Shoe **\$229<sup>99</sup>** PR ★



**CARRY GOAL**

- 8'H x 24"W goal, convenient carry bag, 4 ground stakes and one full size weather resistant net
- Constructed of 2" extra-strong aluminum tubing
- Fast break-down and convenient portability with a 3-piece front crossbar system
- Optional all-surface conversion shoes available. 2/pr required per goal
- Weight: 60 lbs.

**STS6PTBG** Goal & Net **\$789<sup>99</sup>** EA ★ **S&H**  
**1366835** Optional All Surface Shoe **\$229<sup>99</sup>** PR ★





## BOWNET

### PORTABLE SOCCER GOAL

- Rigid steel and fiberglass pole patented design
- No tools needed
- Assembles in minutes
- Tear resistant nylon netting
- Free carry case included

1297461	3'H x 5'W	\$169 <sup>99</sup> EA
1394974	4'H x 6'W	\$219 <sup>99</sup> EA
1297478	4'H x 8'W	\$249 <sup>99</sup> EA
1297485	5'H x 10'W	\$389 <sup>99</sup> EA
1297492	6'H x 12'W	\$419 <sup>99</sup> EA
1305746	7'H x 14'W	\$449 <sup>99</sup> EA
1462184	6.5'H x 18'W	\$484 <sup>99</sup> EA
1315899	7'H x 21'W	\$799 <sup>99</sup> EA
1315882	8'H x 24'W	\$829 <sup>99</sup> EA



### PK PRO 2 PRECISION SNIPERS NET

- The PK-Pro II is designed to help increase players goal scoring abilities
- Scoring zones highlight where goalkeepers have a hard time reaching during a penalty kick, free-kick or long shot
- Fits 8' x 24' goals and includes hook/loop attachments to posts
- Carry Bag Included

1460513	\$399 <sup>99</sup> EA
---------	------------------------

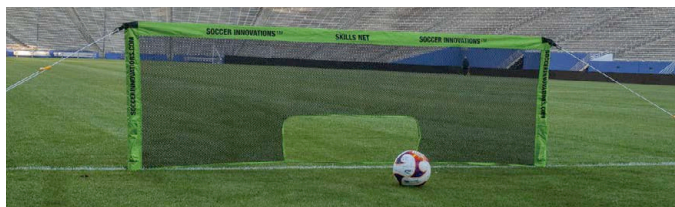

### SOCCER SKILLS NET

- Develops air and ground passing skills
- Forces players to keep the ball on the ground
- Used for training as a simple passing gate
- 1'H x 3'W opening
- Carry Bag included

1460514	\$139 <sup>99</sup> EA
---------	------------------------



### BSN SPORTS

#### POP UP SOCCER GOAL

- Nylon net with fiberglass poles (2-pack)
- Ground stakes - attached to the net
- Pop-up design offers quick set-up and take-down
- Includes a carry bag for transport and storage

1393444	Royal - 30"W x 20"H x 18"D	\$79 <sup>99</sup> PR ★
1393445	Red - 48"W x 38"H x 36"D	\$109 <sup>99</sup> PR ★
1393446	Black - 72"W x 48"H x 48"D	\$144 <sup>99</sup> PR ★



### PUGG® SOCCER GOAL

- Great for soccer training, as well as field or floor hockey practice
- Pop-up design allows for quick and easy set up
- Anchoring pegs included to secure the goal to the ground
- Includes two goals, anchoring pegs and a storage bag

1277180	Yellow/Black - 30"W x 24"H x 22"D	\$109 <sup>99</sup> PR
1063943	Royal - 48"W x 32"H x 32"D	\$164 <sup>99</sup> PR
1063936	Gold - 72" W x 42"H x 42"D	\$199 <sup>99</sup> PR



## FUN FOR ALL AGES AND SKILL LEVELS

**FUNNETS™** are made of a unique blend of materials designed specifically for outdoor use. Our heavy body construction is UV treated and is unbreakable. We know you have seen the imitation PVC plastic goals which are made of tubing designed for plumbing applications. These imitation goals have a very low impact resistance which can cause the piping to break and expose sharp edges.

Our **5 Year Unlimited Warranty** is the best in the industry.

**DON'T BE FOOLED BY CHEAP IMITATIONS!**

### SPORTSTUFF® ROD

Our engineers searched for the perfect blend of flex/strength ratio. The result was the Sportstuff® rod. A safe, unbreakable rod with UV stabilizers, that lasts a lifetime!



**FUNNETS® FITTINGS**  
The Funnet® fitting is molded out of ABS plastic with UV stabilizer for long life and strength. The fittings are longer for a more secure fit. Each fitting has set screws which allow the fitting to be tightened securely to the rod.



**EASY TO CARRY AND TRANSPORT**

### FUNNET® GOALS

- 1 5/8" O.D. heavy duty rods and indestructible ABS fittings
- Comes complete with 3mm blue net

#### 1. 3'H X 4'W X 1.5'D

<b>1150056</b>	Goal w/Net - 1 Each	<b>\$179<sup>99</sup></b> EA ★
<b>1150070</b>	Replacement Net - 3mm, Blue	<b>\$29<sup>99</sup></b> EA ★

#### 2. 4'H X 6'W X 2'D

<b>1150025</b>	Goal w/Net - 1 Each	<b>\$239<sup>99</sup></b> EA ★
<b>1150049</b>	Replacement Net - 3mm, Blue	<b>\$39<sup>99</sup></b> EA ★

#### 3. 6'H X 8'W X 3'D

<b>1149982</b>	Goal w/Net - 1 Each	<b>\$249<sup>99</sup></b> EA ★
<b>1150018</b>	Replacement Net - 3mm, Blue	<b>\$59<sup>99</sup></b> EA ★

#### 4. 7'H X 10'W X 5'D

<b>1249095</b>	Goal w/Net - 1 Each	<b>\$299<sup>99</sup></b> EA ★ <b>SALE</b>
<b>1162356</b>	Replacement Net - 3mm, Blue	<b>\$69<sup>99</sup></b> EA ★



### TRAVEL CHAIR BENCH

- Portable, collapsible bench that sets up in seconds
- Made from high-density 600D polyester
- Comes with mesh pouch at one end of bench for storage
- Bench is rated to support up to 300 lbs. per seat
- Option to customize with a one-color team name or logo on bench seat
- Allow 3 - 4 weeks for delivery of custom benches after art approval

<b>1392979</b>	6-Seater - Black	<b>\$179<sup>99</sup></b> EA
<b>1392980</b>	6-Seater - Royal	<b>\$179<sup>99</sup></b> EA
<b>1451701</b>	6-Seater - Black w/1-Color Logo on One Seat	<b>\$199<sup>99</sup></b> EA
<b>1451702</b>	6-Seater - Royal w/1-Color Logo on One Seat	<b>\$199<sup>99</sup></b> EA





### SEGMENTED CORNER FLAGS

- 4-section 1" PVC material
- Bottom section is inserted and glued to the spring
- All 4-sections are connected by an interior 3mm cord, so pieces are not lost when disconnected
- 4 Flags/Set - Carry bag included

**1238624** 72"H **\$124<sup>99</sup>** SET ★

### COACH'S CHOICE

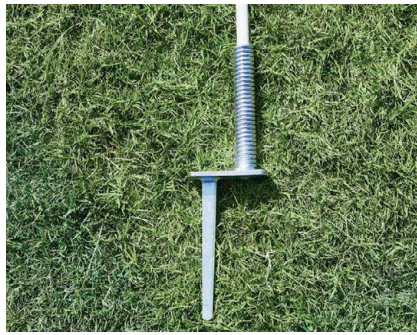

### FLEXIBLE CORNER FLAGS

- One piece construction
- 1/2" flexible PVC upright
- Steel spring base with ground stake
- 4 Flags/Set

**MSSOCFLGY** Poles w/Flags - 60"H **\$119<sup>99</sup>** SET ★  
**1393451** Replacement Flag (4/Set) **\$15<sup>99</sup>** SET ★

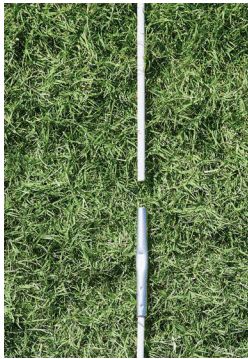
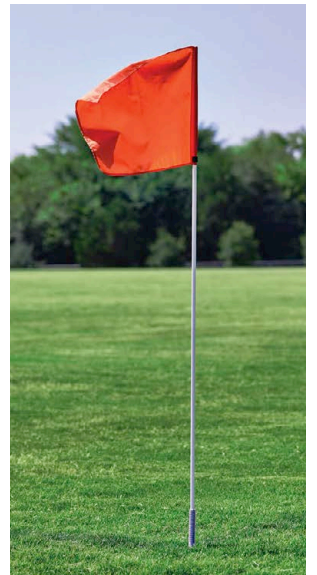

### FIBERGLASS CORNER FLAGS

- Extra durable and light weight
- Two piece pole
- 4 Flags/Set

**20012999** 60"H **\$56<sup>99</sup>** SET ★



### INDOOR/OUTDOOR CORNER FLAGS

- Can be used on turf surfaces
- Uses a spring loaded dome base
- Base must be filled with sand
- 4 Flags/Set

**1251838** 60"H **\$119<sup>99</sup>** SET ★

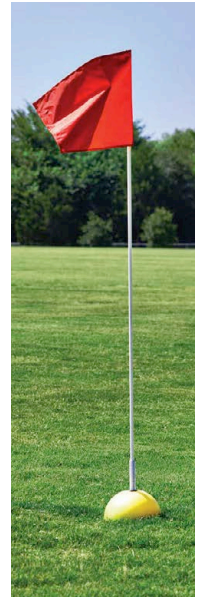

### CORNER FLAG CARRY BAG

- Carries corner flags or coaching sticks
- Black Only

**1366514** 70"L x 7"W **\$19<sup>99</sup>** EA ★



### RUBBER BASE CORNER FLAGS

- 4-Section 1" PVC material
- Sections are connected with 3mm bungee cord
- Pole inserts into heavy rubber base, no additional weight is required
- 4 Flags/Set

**1454490** 60"H **\$149<sup>99</sup>** SET ★

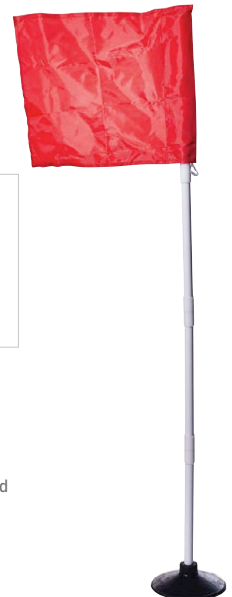



### LOW PROFILE CONES

- Soft, flexible and stack easily
- Color code your drills for more effective practice time
- Available in Orange, Yellow or Prism Packs (2 each: Blue, Green, Orange, Purple, Red and Yellow)
- 3"H x 7 3/4" diameter

<b>1255706</b>	Orange	\$17.99	DZN ★
<b>1276558</b>	Yellow	\$19.99	DZN ★
<b>1255690</b>	Prism Pack	\$14.99	DZN ★



### LOW-PROFILE CONES WIRE CARRIER

- Holds up to 60 low-profile field cones (cones not included)
- Easy carry and storage

<b>93095XXX</b>	\$8.99	EA ★
-----------------	--------	------

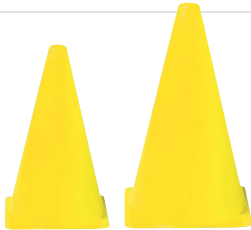

### ECONOMY CONES

- Lightweight vinyl with small base
- No hole in top

<b>MSCONE9XY</b>	9"	\$7.99	EA ★
<b>MS12CONEY</b>	12"	\$7.99	EA ★



### ORANGE GAME CONES

- Flexible PVC with weighted base for added stability
- Stack easily for storage

<b>1040814</b>	12"	\$16.99	EA ★
<b>1040838</b>	18"	\$19.99	EA ★
<b>1040845</b>	28"	\$39.99	EA ★
<b>1040852</b>	36"	\$51.99	EA ★
<b>1040852SET</b>	36"	\$249.99	SET OF 5



### LARGE PROFILE CONES

- Soft-style - flexible and stackable
- Mix with low profile cones for various drills
- Approximately 6"H x 11" diam.

<b>1273687</b>	Orange	\$29.99	DZN ★
<b>1336511</b>	Yellow	\$29.99	DZN ★



### REFLEX SOCCER CORNER FLAGS

- Reflex corner flag
- 1-Piece 1.33" O.D. PVC poles
- High visibility orange flags
- Includes: 4 flags with ground sockets & plugs and installation accessory kit. Storage bag not included

<b>MK4RF6SP</b>	66"H	\$199.99	SET
-----------------	------	----------	-----



- Includes: 6 flags with ground sockets & plugs and installation accessory kit. Storage bag not included.

<b>MK6RF6SP</b>	66"H	\$239.99	SET
-----------------	------	----------	-----

<b>MKA101</b>	Ground Socket with Plug	\$12.99	EA
---------------	-------------------------	---------	----

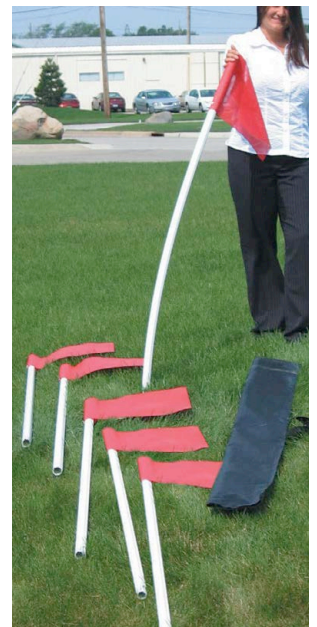

### SPRING LOADED SOCCER CORNER FLAGS

- Spring loaded corner flags that "give" when contacted by a player and return upright automatically
- 2-Piece 1.33" O.D. PVC poles
- High visibility orange flags
- Includes: 6 flags with ground sockets with plugs, installation accessory kit and storage bag.

<b>MK6X6S</b>	60"H	\$299.99	SET
---------------	------	----------	-----



<b>MKA101</b>	Ground Socket with Plug	\$12.99	EA
---------------	-------------------------	---------	----

### SOCCER FIELD LINING KIT

- Set includes: 25 sockets with plugs, 8 line pegs, installation accessory kit (IAK).
- All the necessary tools and products to establish permanent reference points for a regulation soccer field

<b>MKSLP25</b>	\$329.99	EA
----------------	----------	----

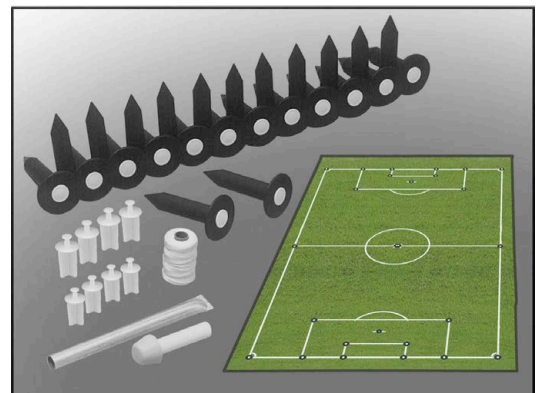





**Soccer INNOVATIONS**

### MAGNETIC HINGED TACTIC BOARD

- Magnetic Tactic Board is one of a kind, unique design allows you to fold it and take it anywhere you go
- Features a full pitch view to help simulate game situations
- Divided sides to give you a more focused display on each half for tactical analysis



1460515	30cm x 45cm-Small	\$54 <sup>99</sup> EA
1460516	90cm x 120cm-Large	\$204 <sup>99</sup> EA

### REFEREE/OFFICIALS WATCH

- Dual Game Timers - one counts down from full minutes, while the other counts up in 1/100 seconds
- Water resistant to 30 meters
- 50 memory recall Stopwatch with 1/100 second resolution
- User replaceable CR-2032 battery



1399653	SC-591	\$48 <sup>99</sup> EA
---------	--------	-----------------------



### CAPTAIN'S ARM BAND

- Velcro closure and extra elastic to keep in position on the arm
- Color Options: **Black, Blue, Orange, Pink, White, Green.**

1371625	Specify Color	\$7 <sup>99</sup> EA
---------	---------------	----------------------



### LINESMAN FLAGS

- One red and one yellow 12" x 15" nylon flag
- 18" wood sticks with knob handles

MSLFECON	\$14 <sup>99</sup> PR ★
----------	-------------------------



### DRY-ERASE BOARDS

- Large format enables entire team to see play
- 2 writing surfaces
- Great pen clip with premium dry erase marker
- 12 1/2" H x 16 1/2" W - 2 lbs.

1366485	\$35 <sup>99</sup> EA
---------	-----------------------



### REVERSIBLE SCRIMMAGE VESTS

- Polyester mesh construction
  - Reversible jerseys with elastic bottom
- Color Options: **Dark Green/Gold, Orange/Gold, Red/Black, Royal/Gold, Royal/Red, Silver/Black.**

1262711	Adult	\$89 <sup>99</sup> DZN ★
1262773	Youth	\$89 <sup>99</sup> DZN ★



NEW NEON COLORS!

### LIGHTWEIGHT SCRIMMAGE VESTS

- Polyester mesh vest
- Reinforced neck and armholes
- Elastic waistband

Color Options: **Black, Gold, Kelly, Neon Green, Neon Orange, Neon Yellow, Orange, Purple, Royal, Scarlet.**

C46Y	K thru 3rd Grade	\$6 <sup>99</sup> EA ★
C46	4th-6th Grade, Middle School & Up	\$7 <sup>99</sup> EA ★
C47N	Adult (# 1-12) GO,KE,OR,PU,RO,SC,BK	\$91 <sup>99</sup> DZN ★



### WARNING CARDS AND WALLET

- Vinyl wallet holds one red and one yellow 3" x 4" plastic warning card
- Cards included

MSREFWAL	\$7 <sup>99</sup> EA ★
----------	------------------------

**BSN SPORTS**

### SOCCER SCOREBOOK

- 22 lines, 28 games
- Includes schedule and team roster

**MSSOCBOK** \$13<sup>99</sup> EA

### SOCCER COACH'S BOARD

- Front half field and back full field writing surfaces
- Includes premium dry erase marker
- 8"W x 15 1/2"L

**1388110** \$27<sup>99</sup> EA ★



### CLASSIC ROUND POSTS

- Constructed of round tubular steel
- Powder coated finish
- Complete with brass winder and lacing bars
- Ground sleeves sold separately

#### 3" Posts - Standard Height

<b>1234404</b>	Green	\$449 <sup>99</sup> PR ★
<b>1234411</b>	Black	\$449 <sup>99</sup> PR ★

#### 2 7/8" Posts - Standard Height

<b>1234428</b>	Green	\$439 <sup>99</sup> PR ★
<b>1234435</b>	Black	\$439 <sup>99</sup> PR ★

### GROUND SLEEVES

- Optional galvanized steel ground sleeves for Edwards Classic Round Post
- Sleeve plugs included

<b>1235708</b>	For 2 7/8" Posts	\$89 <sup>99</sup> PR ★
<b>1234473</b>	For 3" Posts	\$119 <sup>99</sup> PR ★



### 10 & UNDER TENNIS / PICKLEBALL

- Sized right for 10 & Under Tennis and Pickleball
- Constructed of 3" round tubular steel
- Powder coated finish - 36" above ground height
- Complete with brass winder and lacing bars
- Ground sleeves and net sold separately

<b>1371705</b>	Green Post	\$449 <sup>99</sup> PR ★
<b>1393373</b>	Black Post	\$449 <sup>99</sup> PR ★
<b>1234473</b>	Optional Ground Sleeve - 3" Post	\$119 <sup>99</sup> PR ★



### EXTERNAL RATCHET POSTS - 2 7/8"

- 2 7/8" OD, powder coated steel
- Complete with ratchet, caps and pulley
- Safety ratchet has a detachable handle
- For permanent installation or semi-permanent (with optional ground sleeves)

<b>TP278GRN</b>	Standard Post - Green	\$249 <sup>99</sup> PR ★
<b>1263138</b>	Standard Post - Black	\$249 <sup>99</sup> PR ★

### GROUND SLEEVES

- PVC ground sleeves for 2 7/8" external ratchet posts

<b>MTPGS27</b>	\$66 <sup>99</sup> PR ★
----------------	-------------------------

### REPLACEMENT SAFETY RATCHET

- Heavy-duty steel safety ratchet
- Will fit most existing posts

<b>MTRT5XXX</b>	Green	\$34 <sup>99</sup> EA ★
<b>1002430</b>	Black	\$34 <sup>99</sup> EA ★

### POST CAPS

- Steel post cap and pulley
- Fits 2 7/8" post only

<b>MTCAP278</b>	Green	\$44 <sup>99</sup> EA ★
<b>1002485</b>	Black	\$44 <sup>99</sup> EA ★



### BRASS WINDER UNITS

- Includes removable handle and screw

1. <b>1234527</b>	Winder Unit - Round Post	\$199 <sup>99</sup> EA ★
2. <b>1234534</b>	Winder Unit - Square Post	\$199 <sup>99</sup> EA ★
<b>1234510</b>	Handle Only	\$69 <sup>99</sup> EA ★



### WIMBLEDON SQUARE POSTS

- Constructed from 3" square "box-section" steel
- Powder coated finish
- Complete with brass winder and lacing bars
- Ground sleeves sold separately

<b>1234459</b>	Green	\$479 <sup>99</sup> PR ★
<b>1234442</b>	Black	\$479 <sup>99</sup> PR ★

### GROUND SLEEVES

- Optional galvanized steel ground sleeves for Edwards 3" Square Posts

<b>1234480</b>	\$119 <sup>99</sup> PR ★
----------------	--------------------------





Throughout their 130 year history, Edwards Sports Products have been associated with tennis at the highest level, supplying Grand Slam tournaments around the world including Wimbledon & US Open. The famous 40LS net features double netting on the top six rows and a specially designed polyester headband which maximizes durability and minimizes distortion. The 30LS, 30LSDC and 40LS feature extra heavy duty 3.5mm braided polyethylene twine. These tennis nets have a quad stitched white top band & a plastic coated steel cable. The 30LS, 30LSDC & 40LS use only the finest quality materials.

Standard net posts are spaced 42' apart. 42' nets measure 41'6" to fit between these posts. For 40' post spacing, use the 40' net which measures 39'6".



**VARSITY 300**

- 2.5mm high density braided polyethylene net body
- Heavy duty 18 oz. vinyl coated headband
- 4 rows of lock stitching in headband
- 5/8" diameter fiberglass dowel
- Center strap not included

**TN300V42Y** 42'L \$199<sup>99</sup> EA ★



**SUPER PRO 5000**

- 3.6mm high density braided polyethylene net body
  - Heavy duty 18 oz. vinyl coated headband
  - 5/8" diameter fiberglass dowels
  - Center strap not included
- 3 Year Limited Warranty**  
Length: 40', 42'.

**TN500** Specify Length \$244<sup>99</sup> EA ★



**30LS DOUBLE CENTER**

- 3.5mm high density braided polyethylene net body
  - Heavy duty 18 oz. vinyl coated headband
  - 5 rows of double center mesh
  - 5/8" diameter fiberglass dowels
  - Center strap and tapered center
- 5 Year Limited Warranty**

**1234367** 42'L \$339<sup>99</sup> EA ★



**40LS DOUBLE CENTER**

- 3.5mm high density braided polyethylene net body
  - Heavy duty 155mm polyester headband
  - 5 rows of double center mesh
  - 5/8" diameter fiberglass dowels
  - Center strap and tapered center
- 5 Year Limited Warranty**

**1162462** 42'L \$349<sup>99</sup> EA ★



**10 & UNDER TENNIS / PICKLEBALL**

- 3.5mm braided, knotless nylon netting with 1-3/4" square mesh
- Heavy duty vinyl coated headband
- 5/8" diameter fiberglass dowels
- 42"H x 22"L used for 10 & Under Tennis
- 36"H x 22"L used for 8 & Under Tennis and Pickleball

**1296785** 10 & Under-42"H x 33"L \$229<sup>99</sup> EA ★  
**1296778** 8 & Under/Pickleball-36"H x 22"L \$189<sup>99</sup> EA ★



**AUSSIE**

- 3.0mm high density braided polyethylene net body
  - Heavy duty 18 oz. vinyl coated headband
  - 7/8" diameter fiberglass dowels
  - Center strap and tapered center
- 3 Year Limited Warranty**

**1234374** 42'L \$249<sup>99</sup> EA ★



**OUTBACK DOUBLE CENTER**

- 3.0mm high density braided polyethylene net body
  - Heavy duty 18oz vinyl coated headband
  - 5 rows of double center mesh
  - 5/8" diameter fiberglass dowels
  - Center strap and tapered center
- 5 Year Limited Warranty**

**1234398** 42'L \$309<sup>99</sup> EA ★



**30LS**

- 3.5mm high density braided polyethylene net body
  - Heavy duty 18 oz. vinyl coated headband
  - 5/8" diameter fiberglass dowels
  - Center strap and tapered center
  - Edwards most popular net, and the one used at Wimbledon
- 3 Year Limited Warranty**

**1162479** 42'L \$299<sup>99</sup> EA ★

# RolDri *THE ORIGINAL WATER REMOVER*



## MASTER SPONGE ROLLER

- 36" wide roller is made of tough durable polyvinyl alcohol (PVA) foam
- Designed to push water off your court surface
- Anodized aluminum handle with stainless steel, black powder coated T-socket
- Stainless steel, powder coated frame includes all stainless steel hardware
- Replacement rollers include end caps

**MTRDMSTR** Complete Unit **\$119<sup>99</sup>** EA ★  
**MTRRTBLU** Master Replacement Roller **\$69<sup>99</sup>** EA ★



STAINLESS STEEL T-SOCKET

ROL-DRI<sup>®</sup> SEAMLESS SPONGE ROLLER

ROL-DRI<sup>®</sup> MASTER SPONGE ROLLER

## SEAMLESS SPONGE ROLLER

- Gray seamless sponge roller is made of soft absorbent polyurethane (PU) foam - 36" Wide
- Designed to absorb and push water from your court surface
- Anodized aluminum handle with stainless steel, black powder coated T-socket
- Stainless steel powder coated frame includes all stainless steel hardware
- Can also be used on damp grass to improve field conditions
- Replacement rollers include end caps

**MTRDSMLS** Complete Unit **\$109<sup>99</sup>** EA ★  
**MTRRSL36M2** Seamless Replacement Roller **\$54<sup>99</sup>** EA ★

## REPLACEMENT PARTS/ACCESSORIES

- Set includes: handle, hard poly grip, stainless steel T-bracket, hanging clip, and screws
- All hardware is stainless steel

**MTHDLASM** Handle Assembly Set **\$59<sup>99</sup>** EA ★

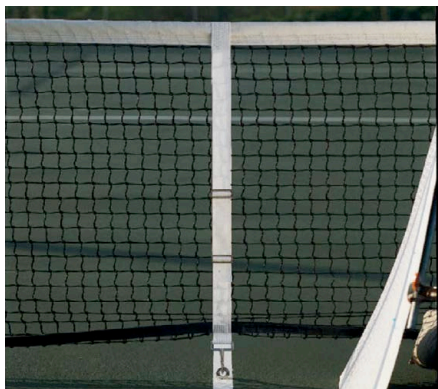

## POLYESTER CENTER STRAP

- All polyester center strap
- Complete with all hardware to attach strap to net
- 5 Year Limited Warranty

**1158267** **\$19<sup>99</sup>** EA ★

## MacGregor CENTER STRAP

- 100% nylon center strap
- 100% synthetic nylon webbing

**MTCSTRAP** **\$16<sup>99</sup>** EA ★

## GROUND ANCHOR

- Heavy duty zinc plated ground anchor

**1234466** **\$17<sup>99</sup>** EA ★

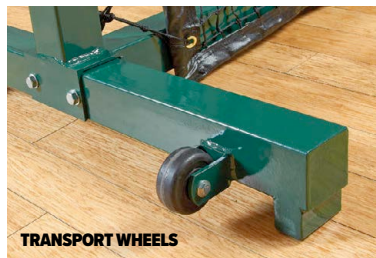

TRANSPORT WHEELS



STEEL WINDER



## FREE-STANDING TENNIS SYSTEM

- Made of 3" powder coated square steel with stainless steel winder
- Includes three joining bars
- Transport wheels on each standard
- Net not included with system (See p. 223 for options)
- Indoor/Outdoor use

**1244205**

310 lbs.

**\$1,299<sup>99</sup>** SET ★ **SALE**

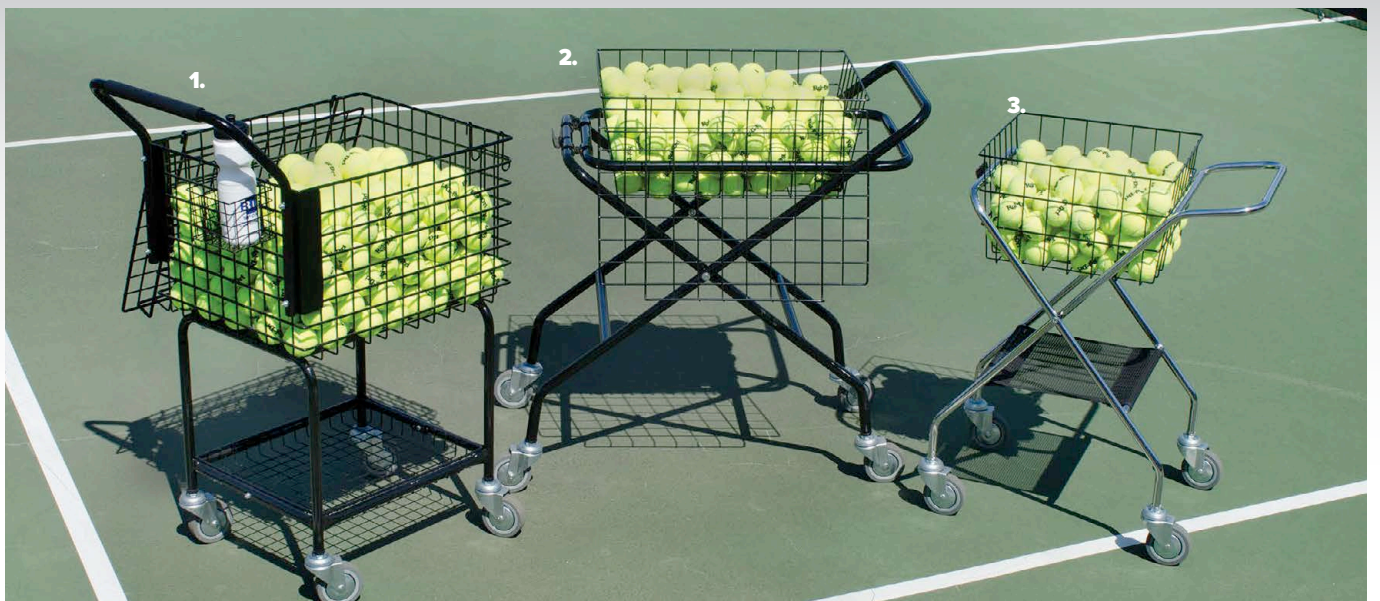

### 1. DELUXE TEACHING CART

- Powder coated steel frame, vinyl coated basket with foam grip
- Rubber 4" wheels with sealed ball bearings
- Locking lid that lays flat against the side
- Includes basket hanger and convenient water bottle holder
- Holds 325 tennis balls
- Basket Height - 42 1/2"H
- Top Basket - 19" W x 23"L

**1342550**

\$449<sup>99</sup> EA ★

### 2. FOLDABLE TEACHING CART

- Powder coated steel frame, vinyl coated basket with foam grip
- Folds easily for storage and transportation
- 4" rubber wheels with sealed ball bearings
- Lockable lid
- Includes basket hanger
- Holds 250 tennis balls
- Basket Height - 38"H
- Basket size - 20"W x 30"L

**1342543**

\$399<sup>99</sup> EA ★

### 3. MINI TEACHING CART

- Chrome steel construction with removable basket
- Folds easily for storage and transportation
- 4" smooth rolling rubber wheels
- Includes mesh bottom storage tray and convenient basket hanger on front of cart
- Hold 150 tennis balls
- Basket height - 34"H
- Basket size - 18"W x 25"L

**1369476**

\$299<sup>99</sup> EA ★

### 85 BALL RETRIEVER

- Heavy duty wire construction
- 32"H - 5 lbs.

**MTRETRIE** \$66<sup>99</sup> EA



### 70 BALL RETRIEVER

- Heavy duty wire construction
- Handles flip over to create stand for ball dispensing
- 32"H - 6 lbs.

**MTINSTRU** \$69<sup>99</sup> EA

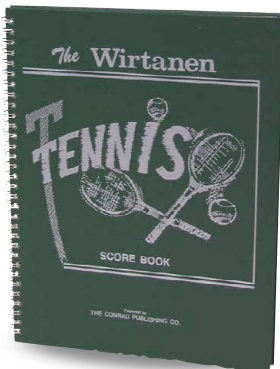
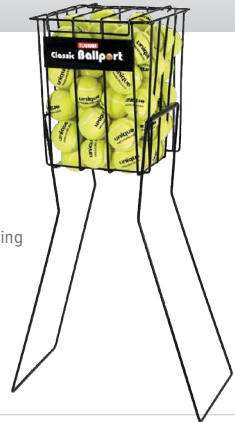

### WIRTANEN TENNIS SCOREBOOK

- Includes: 32 matches, summary sheets, tournament charts, individual player records and instructions.

**1303254**

\$30<sup>99</sup> EA ★

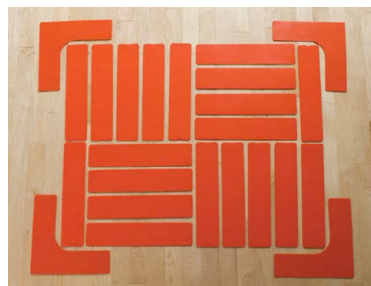

### QUICK-MARK BOUNDARY MARKERS

- Create boundaries quickly and easily
- Poly-vinyl, non-skid markers
- Includes (20) 12 1/2"L x 2"W lines and (4) 12" corners

**Lifetime Warranty**  
Color Options: **Orange.**

**45085**

\$199<sup>99</sup> SET OF 24 ★



### ROLL OUT LINE

- Use in place of floor tape
- Vinyl roll will lay flat on a gym floor, outside on the playground or anywhere you need a temporary boundary/court line
- 33'L x 3"W x 1/8" thick

**1292138**

\$69<sup>99</sup> EA ★



### TUFFY® WINDSCREEN

- The toughest, highest quality windscreen in the world
  - Made with exclusive Vipo® Matrix 10 oz. material, a super-durable mesh fabric of tightly woven micro fibers
  - Offers more sun UV resistance, is virtually tear proof, and has the highest puncture and tear resistance
  - Allows 22% wind pass-through - 78% shade factor
  - Tuffy is the only windscreen featuring LOCK-STITCH finishing to assure that it's sides and corners do not unravel
  - Fully sun UV and mildew inhibitor protected
  - Grommeted every 12" on all 4 sides
  - 9' model complete with half moon vents and a grommet strip line
- 5 Year Limited Warranty**

#### Without Printing

1323566	up to 5'H	\$1.45	SQ.FT
1285598	6'H	\$1.59	SQ.FT
1285604	9'H	\$1.69	SQ.FT

#### With Chroma-Bond® Digital Imprinting

1452960	up to 5'H	\$9.49	SQ.FT
1452961	6'H	\$9.49	SQ.FT
1452962	9'H	\$9.49	SQ.FT

#### TUFFY® WINDSCREEN ACCESSORIES

1298253	Boxed Air Vent	\$15.99	EA
<b>MITWRAPS</b>	7" Tie Wraps (50 lbs. brk strength - pk of 100)	\$52.99	PACK





**QUALITY • DURABILITY • CRAFTSMANSHIP**



**BSN SPORTS**

**POLYESTER WINDSCREEN**

- 8oz. weight/sq. yard construction, 84% shade factor, maximum UV protection
- Custom cut to any size
- Brass tooth grommets spaced every 18" on all four sides
- IncrediSeal - eliminates all sewing and stitching
- 9' comes standard with lacing lip and half moon vents
- Match school logos exactly-digitally printed directly from your image file
- State of the art digital printing with unlimited color options

**Without Printing**

1393784	up to 5'H	\$1.17	SQ.FT
1393785	6'H	\$1.23	SQ.FT
1393786	9'H	\$1.27	SQ.FT

**With Printing**

1398129	up to 5'H	\$7.49	SQ.FT
1398130	6'H	\$7.49	SQ.FT
1398131	9'H	\$7.49	SQ.FT



**POLY AND ARMORMESH WINDSCREEN ACCESSORIES**

1397737	Boxed Vent	\$14.99	EA
1397738	Lacing Lip	\$0.10	EA
<b>MTTWRAPS</b>	7" Tie Wraps (50 lbs. brk strength - pk of 100)	\$52.99	PACK



**ARMORMESH WINDSCREEN**

- Features 14 oz. woven, extrusionvinyl-coated polyester
- Excellent tear strength and outstanding abrasion resistance
- Fabricated with IncrediSeal technology
- 75% shade factor
- Lacing lip and half moon vents standard on screens over 6'
- Match school logos exactly-digitally printed directly from your image file
- State of the art digital printing with unlimited color options

**Without Printing**

1393787	up to 5'H	\$1.12	SQ.FT
1393788	6'H	\$1.17	SQ.FT
1393789	9'H	\$1.19	SQ.FT

**With Printing**

1398132	up to 5'H	\$7.99	SQ.FT
1398133	6'H	\$7.99	SQ.FT
1398134	9'H	\$7.99	SQ.FT





### TIDI-COOLER STAND SET

- Includes: stand, trash can, 5 gallon Igloo® cooler, and cup dispenser

<b>1263244</b>	Black Stand with Green Cooler	<b>\$299<sup>99</sup></b> SET ★
<b>1263251</b>	Black Stand with Yellow Cooler	<b>\$299<sup>99</sup></b> SET ★
<b>1255669</b>	Green Stand with Green Cooler	<b>\$299<sup>99</sup></b> SET ★
<b>1255676</b>	Green Stand with Yellow Cooler	<b>\$299<sup>99</sup></b> SET ★



### TIDI-COOLER STAND

- 100% lightweight, rust free aluminum with powder coated finish
- Wide stance base for more stability
- Includes Tidi-Court basket and security cable with keyed lock to keep lid and cooler secure to stand
- Designed for 5 gallon coolers
- Cooler sold separately

<b>1255652</b>	Green Stand & Basket	<b>\$249<sup>99</sup></b> EA ★
<b>1263268</b>	Black Stand & Basket	<b>\$249<sup>99</sup></b> EA ★



### WATER COOLER

- Rugged, durable 400 series industrial strength water coolers with Ultratherm™ insulation keeps water ice cold
- UV Protection prevents surface from chipping, peeling, or rusting
- FDA approved white inner liner is easy to clean and resists stains
- Lid cord attached to prevent loss
- Optional cup dispenser holds approximately 200 (4 or 4.5 oz.) cups-not included

<b>MSIGLO5X</b>	Yellow - 5 Gal.	<b>\$89<sup>99</sup></b> EA
<b>MSIGLO10</b>	Yellow - 10 Gal.	<b>\$119<sup>99</sup></b> EA
<b>1263220</b>	Green - 5 Gal.	<b>\$89<sup>99</sup></b> EA
<b>1263237</b>	Green - 10 Gal.	<b>\$129<sup>99</sup></b> EA
<b>1376916</b>	Orange - 5 Gal. Seat Top	<b>\$82<sup>99</sup></b> EA
<b>1384468</b>	Orange - 10 Gal. Seat Top w/Cup Dispenser	<b>\$119<sup>99</sup></b> EA
<b>MSCUPDIS</b>	Optional Cup Dispenser	<b>\$39<sup>99</sup></b> EA
<b>1384470</b>	4.25 oz. Cone Cup - 5000/Case	<b>\$249<sup>99</sup></b> EA



### TIDI-COURT

- Empty your pockets, store your drink cups and cans and keep trash where it belongs with the Tidi-Court
- Uses a simple hose clamp attachment to fit any shape or size post

<b>TNVALET</b>	Green	<b>\$69<sup>99</sup></b> EA ★
<b>TNVALETB</b>	Black	<b>\$69<sup>99</sup></b> EA ★

### Replacement Basket

- Handy replacement basket keeps trash where it belongs...off your court

<b>TNKPRBSK</b>	Green	<b>\$39<sup>99</sup></b> EA
<b>TNKPRBSKB</b>	Black	<b>\$39<sup>99</sup></b> EA

### Replacement Tray

- Convenient valet tray for storing valuables during play

<b>TNKPRTRY</b>	Green	<b>\$32<sup>99</sup></b> EA
<b>TNKPRTRYB</b>	Black	<b>\$32<sup>99</sup></b> EA

### Replacement Clamp

- Hose clamp attachment to fit any shape or size post

<b>TNKPRCLP</b>		<b>\$14<sup>99</sup></b> EA
-----------------	--	-----------------------------

### TENNIS SCORE TUBE™

- Use tennis balls to keep score
- PVC tube with holes to indicate set score
- A stainless steel hose clamp is supplied to secure to post or net
- Hooks are supplied for fence mounting
- Color Options: **Black, Blue, Green, White.**

<b>1296099</b>	Specify Color	<b>\$59<sup>99</sup></b> EA
----------------	---------------	-----------------------------



### QUICKSCORE

- Portable scorecard that sits on top of the net.
- Includes both game & set scores.
- Contains game numbers up to 7 to allow scoring for regular as well as pro sets



<b>1274219</b>	Set of 4	<b>\$229<sup>99</sup></b> SET
----------------	----------	-------------------------------





### QUICKSTART ROLL-A-NET

- Adjusts from tennis height up to badminton height
- Weather-resistant polyester paint to help avoid rusting with outdoor use
- Easily wheels on and off the court with locking wheels
- Center support wheel with adjustable net tension
- Net rolls up easily and stores in nylon bag with wheels

1377091

\$389<sup>99</sup> EA

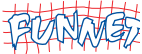

### PORTABLE NET SYSTEM

- Portable net system for a variety of games and activities
- Ideal for beginning tennis, badminton & volleyball
- Height adjustable from 32" to 52"
- Comes complete with carrying case



<b>1282450</b>	10'L Model	\$179 <sup>99</sup> EA ★
<b>1282467</b>	18'L Model	\$209 <sup>99</sup> EA ★



### QUICKSTART MINI AND MAXI NET SYSTEMS

- Portable net systems for a variety of activities and lead-up games, including tennis, badminton and beginner volleyball
- Nets are easy to set up and take down in 2 minutes or less without tools
- Constructed of durable oval metal tubing
- Mini Net adjusts from 30" - 52" high
- Maxi Net adjusts from 30" to 64" high
- Comes complete with carrying case
- Not intended to be left outside for extended periods of time

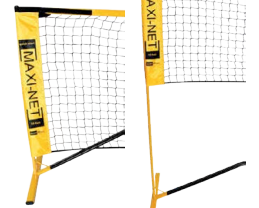

Mini Net

Mini Net with extensions

<b>20025187</b>	Mini Net - 10'L	\$199 <sup>99</sup> EA
<b>20021837</b>	Maxi Net - 18'L	\$229 <sup>99</sup> EA



### RACQUET CART

- Galvanized steel construction
- Holds up to 64 tennis rackets or 100 table tennis paddles
- Non-marring casters for easy transport

<b>1690XXXX</b>	32"L x 14"W x 28"H	\$129 <sup>99</sup> EA ★
-----------------	--------------------	--------------------------



### RACQUET CART

- Stores and transports up to 100 racquets and paddles of all types
- Transport all your badminton or tennis equipment in one trip
- Features a basket for storing tennis balls, shuttlecocks and other accessories

<b>1246131</b>	41"H x 43"W x 19"D	\$399 <sup>99</sup> EA ★
----------------	--------------------	--------------------------



**Penn**  
**CHAMPIONSHIP TENNIS BALLS**

• Can of 3 balls - 24 Cans/Case

**MTPENCAN** \$8<sup>99</sup> CAN



**Penn**  
**PRACTICE/COACH TENNIS BALLS**

• Can of 3 balls - 24 Cans/Case

**MTPENBAL** \$7<sup>99</sup> CAN



**DUNLOP**  
**CHAMPIONSHIP TENNIS BALLS**

• Can of 3 balls - 24 Cans/Case

**MTDUNCAN** \$8<sup>99</sup> CAN



**Wilson**  
**CHAMPIONSHIP TENNIS BALLS**

• Can of 3 balls - 24 Cans/Case

**MTWILCAN** \$8<sup>99</sup> CAN



**RolDri**  
**PRESSURELESS TENNIS BALLS**

• Perfect for practice or recreational tennis

**1704XXXX** \$19<sup>99</sup> DZN ★

**WHAT IS 10 & UNDER TENNIS?** (Formerly Quickstart Tennis)

10 & Under Tennis is a program designed to help kids 10 years old and under learn to play the game of tennis. A few changes have been made to encourage learning the game.....The court sizes. The racquet sizes. The ball sizes. The scoring system. Also, the net height. 10 & Under is now part of the USTA Jr. Tennis league and can be a part of every development program. More kids will be able to enjoy this new format and have lots of fun playing with their friends.

AGE	COURT SIZE	RAQUET	BALL	NET HEIGHT	SCORING
8 yrs & under	36' x 18'	up to 23"	foam or very low compression	2' 9"	-Best 2 out of 3 games -Games to 7 points
10 yrs & under	60' x 21' singles 60' x 27' doubles	up to 25"	low compression	3'	-Best 2 out of 3 sets -Games to 7 points -4 Games = Set -3rd Set Tiebreaker to 7 points



**Penn**  
**QST 36 FOAM BALLS**

- High-density lightweight foam ball
- Oversized diameter for simple learning
- Ideal for indoor court settings
- RED Ball for 36' tennis court size
- Recommended for ages 8 & Under

**1451697** Dozen \$64<sup>99</sup> DZN

# MacGregor

**BEST  
SELLER**



## WIDE BODY SERIES

- Graphite & aluminum fused head and shaft
- O-Beam frame design with PU grip
- Over-size 110 square inch head
- Available in 4 1/4", 4 3/8" or 4 1/2" grip size

<b>1393403</b>	27"L - 4 1/4" Grip (Green/White)	\$35 <sup>99</sup> EA ★
<b>1393404</b>	27"L - 4 3/8" Grip (Blue/White)	\$35 <sup>99</sup> EA ★
<b>1393405</b>	27"L - 4 1/2" Grip (Red/White)	\$35 <sup>99</sup> EA ★



## RECREATIONAL SERIES

- Graphite & aluminum fused head and shaft
- O-Beam frame design with PU grip
- Mid-size 95 square inch head
- Available in 4 3/8" or 4 1/2" grip size

<b>1393401</b>	27"L - 4 3/8" Grip (Orange/Black)	\$32 <sup>99</sup> EA ★
<b>1393402</b>	27"L - 4 1/2" Grip (Green/Black)	\$32 <sup>99</sup> EA ★



## YOUTH SERIES

- Graphite & aluminum fused head and shaft
- O-Beam frame design with PU grip
- Mid-size 95 square inch head
- Available in 21", 23" & 25" length

<b>1393406</b>	21"L - 4" Grip (Black/Yellow)	\$29 <sup>99</sup> EA ★
<b>1393407</b>	23"L - 4" Grip (Black/Orange)	\$29 <sup>99</sup> EA ★
<b>1393408</b>	25"L - 4" Grip (Black/Silver)	\$29 <sup>99</sup> EA ★



## Wilson PRO PRECISION XL

- 11.5oz sq in head
- AirLite alloy construction creates lightweight frame with power and durability
- 4 3/8" grip size

<b>WLWR080310U3</b>	27.25" L	\$44 <sup>99</sup> EA
---------------------	----------	-----------------------



## **NEW!** HEAD TI RADICAL ELITE

- Composite construction for added control and spin
- Oversized Head 105" for controlled power at moderate to full swing speed
- Controlled cushion for maximum comfort
- 4 3/8" grip size

<b>1460803</b>	27" L	\$43 <sup>99</sup> EA
----------------	-------	-----------------------



## Wilson ENERGY XL

- V-Matrix Technology for larger sweet spot
- 10.3 oz strung weight(291g)
- 4 3/8" grip size

<b>1388070</b>	27.5" L	\$41 <sup>99</sup> EA
----------------	---------	-----------------------

## TOURNA GRIP® RACQUET GRIPS

- Extremely durable and well cushioned for maximum comfort and performance
- Use with all tennis, badminton, squash and racquetball racquets
- Comes in a package of 3 rolls, 10 racquets per roll for a total of 30 grips



<b>1065190</b>	\$64 <sup>99</sup> PACK OF 30
----------------	-------------------------------



## HEAD SPEED JR

- Speed racquets are endorsed by top ranked ATP Players
- Perfect for learning at any age
- Bumper guard for added durability
- Official racquet of the UTSA School Programs

<b>1460805</b>	25" L	\$27 <sup>99</sup> EA
----------------	-------	-----------------------



## HEAD TOUR PRO

- Nano Titanium technology provides added power and stability
- Super Oversized 110" head for a maximum sweetspot and extra power
- 4 3/8" grip size

<b>1460804</b>	27" L	\$34 <sup>99</sup> EA
----------------	-------	-----------------------

## PORTABLE BADMINTON GAME STANDARDS

- 2 3/8" OD Flo-coated® galvanized standards
- 24"D steel base with rubber floor protector
- Roll-away wheels, no floor plates necessary
- Includes economy badminton net
- Blue only
- Includes Pickleball settings

**STBMNSTD** 160 lbs. \$1,049<sup>99</sup> PR ★

## PROTECTIVE BASE PAD

- Vinyl covered bonded foam
- Easy to install with hook-and-loop attachments
- Blue only

**1012385** \$189<sup>99</sup> EA ★

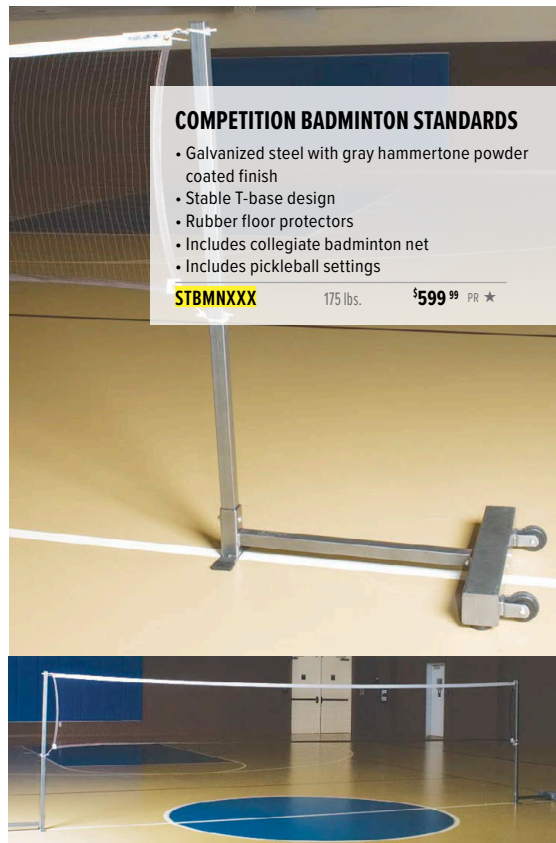

## COMpetition BADMINTON STANDARDS

- Galvanized steel with gray hammertone powder coated finish
- Stable T-base design
- Rubber floor protectors
- Includes collegiate badminton net
- Includes pickleball settings

**STBMNXXX** 175 lbs. \$599<sup>99</sup> PR ★

## Gold Medal<sup>®</sup> BADMINTON NETS

CODE	MODEL	USE	NET	HEADBAND	CABLE	BOTTOM & SIDETAPES	PRICE
<b>MACBMNET</b>	PROFESSIONAL 21' x 2.5'	Competition	Weather treated knotless nylon	White HD vinyl	14" poly rope	Vinyl coated nylon	\$59 <sup>99</sup> EA ★
<b>SNBMNCOL</b>	COLLEGIATE 21' x 2.5'	Intramurals	3/4" mesh nylon	Vinyl coated nylon	Braided nylon - 4mm	Double stitched nylon	\$49 <sup>99</sup> EA ★
<b>SNBMN128</b>	ECONOMY 21' x 2.5'	Recreational	Knotted poly- fiber 3/4" mesh	PVC Vinyl 3mm braided nylon	Braided nylon - 3mm	Single stitched vinyl	\$37 <sup>99</sup> EA ★



## MacGregor<sup>®</sup> TOURNAMENT SHUTTLECOCKS

- Medium speed with nylon feathers and cork tip
- Sold in tubes of 6

1. **MSBIRDNY** White \$17<sup>99</sup> SET OF 6 ★  
 2. **MSBIRDYL** Yellow \$17<sup>99</sup> SET OF 6 ★

## ECONOMY SHUTTLECOCKS

- White, plastic feathers with rubber tip

3. **MSBIRDPL** \$17<sup>99</sup> SET OF 36 ★  
**MSBIRDPG** \$59<sup>99</sup> SET OF 144 ★



## BADMINTON SET

- Includes: 4 nylon strung tempered steel racquets, 1"D steel poles, 2 ground sleeves, 2 shuttlecocks, 2 1/2" H x 20" L net and carry bag

**1651XXXXY** \$49<sup>99</sup> SET ★



## CARLTON<sup>®</sup> SHUTTLECOCKS

- Designed for slow speed/high altitude, medium speed/normal or fast speed/warm conditions
- Sold in tubes of 6
- Weight: 5 grams each

**T800WHGR** Slow/High Altitude \$19<sup>99</sup> TUBE  
**T800WHBL** Medium/Normal \$19<sup>99</sup> TUBE  
**T800WHRD** Fast/Warm \$19<sup>99</sup> TUBE  
**T900WHBL** F2 - Medium/Normal \$23<sup>99</sup> TUBE

# MacGregor



## CHAMP

- Graphite and aluminum fused head and shaft
- Nylon close string with PU grip
- Strung weight: 93 grams
- Length: 26"

1393409

\$23<sup>99</sup> EA ★



## TOURNAMENT 110

- Graphite and aluminum fused head and shaft
- Nylon close string with PU grip
- Strung weight: 110 grams
- Length: 26"

1393410

\$21<sup>99</sup> EA ★



## TWIN 200

- Graphite and aluminum fused head and twin shaft
- Nylon close string with PU grip
- Strung weight: 110 grams
- Length: 26"

1393411

\$19<sup>99</sup> EA ★



## ECONOMY YOUTH

- Graphite and aluminum fused head and shaft
- Nylon close string with PU grip
- Strung weight: 130 grams
- Length: 25"

1393412

\$18<sup>99</sup> EA ★



## ONE-PIECE BADMINTON RACQUET

- One-piece molded racquet
- Lightweight flexible design
- Weight: 130 grams
- Length: 25 1/2"

MSRAQZYT

\$22<sup>99</sup> EA



## Wilson MATCHPOINT

- Two piece aluminum frame and flared inside grommets for maximum durability
- Oversized 53 square inch sweet spot
- Strung weight: 120 grams
- Length: 26"

1310122

\$24<sup>99</sup> EA

# carlton



## AEROBLADE 2000

- Tempered steel for durability
- Isometric shape head
- Ideal economy recreational racquet
- Strung weight: 120 grams
- Length: 26"

1376933

\$18<sup>99</sup> EA



## AEROBLADE 3000

- Isometric Titanium Alloy head
- Tempered Steel Shaft for power and durability
- Ideal racquet for recreational play
- Strung weight: 100 grams
- Length: 26"

1376932

\$21<sup>99</sup> EA



## MAXI BLADE 4.3

- Titanium alloy head with steel shaft
- Ideal racquet for recreational play
- Strung weight: 105 grams
- Length: 26"

20026541

\$26<sup>99</sup> EA



**SONIC TI 5.0**

- Alloy construction
- Weight: 195g
- Head Size: 500sq cm

**1458973** 27" L \$39.99 EA

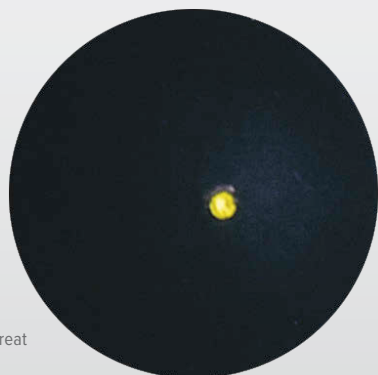

**COMPETITION SQUASH BALL**

- Ball provides great performance and great value for club and intermediate play
- Standard size with a 10% longer hang-time to that of the Dunlop Pro Squash Ball.

**1371547** Dozen \$59.99 EA



**PRO DOUBLE DOT SQUASH BALL**

- Ball is best suited for advanced & serious players.
- The official ball of the WSF (World Squash Federation) and the PSA (Professional Squash Association).
- Low bounce

**1371546** dozen \$64.99 EA



**HEAD**

**IMPULSE**

- Ultra lightweight design with adjustable strap
- Anti-fog treated with shatterproof polycarbonate lenses

**1238983** \$16.99 EA



**USHA 21<sup>®</sup> HANDBALL**

- Exclusively USHA endorsed
- 1 ball per can

**1553XXXX** \$17.99 CAN

# Penn

## PRO GREEN RACQUETBALL

- The official ball of USA Racquetball makes the Pro Penn the most widely used ball in tournament play.
- Bright green color has a great on-court visibility.
- Consistent speed, playability and durability

**1556XXXX** Can of 3 **\$9.99** CAN



## 12-BALL CANISTER

- The world's #1 selling racquetball
- Ultra blue color offers added visibility
- Ideal for all levels of play

**1238976**

**\$33.99** CAN



## HIGH DEFINITION RACQUETBALL

- Penn's new HD High Definition racquetball.
- Optimum on-court visibility
  - Faster, livelier and consistent playability
  - Lighter weight for a more comfortable feel
  - Increased durability

**1557XXXX** Can of 3 **\$9.99** CAN



## ULTRA BLUE RACQUETBALL

- The World's #1 Selling Racquetball
- Ultra blue racquetball gives long, lively, and consistent play
- Microscopic texturization for extra bite

**1555XXXX**

Can of 3 **\$8.99** CAN



# MacGregor



## SCHOLASTIC

- Powder coated aluminum O-Beam frame
- Tear drop head with built-in bumper
- Open throat design
- Soft 4" PU grip
- Strung weight: 210 grams

**1393414** 22"L **\$29.99** EA ★



## COLLEGIATE

- Tear drop head with aluminum O-Beam frame
- Built-in bumper with open throat design
- Soft 4" PU grip
- Strung weight: 210 grams

**1393413** 22"L **\$32.99** EA ★

# HEAD



## MX CYCLONE

- Metallix alloy provides a stronger, lighter, stiffer and more powerful construction
- Pyramid V PowerZone String Pattern
- Head Size 106.5 sq. in. - Grip Size 3-5/8"
- Weight - 190 grams

**1459273** 22"L **\$43.99** EA



### PORTABLE PICKLEBALL NET

- 34"H x 22"W
- Meets USAPA requirements
- Premium carry bag with wheels for easy transportation

**90 Day Limited Warranty**

1454847

\$202<sup>99</sup> EA



## EQUIPMENT



### THE RECRUIT STARTER SET

- Perfect for those pickleball players eager to get out on the court and learn the sport
- Kit includes: 2 hardwood paddles and 2 pickleballs

**90 Day Limited Warranty**

1393481

\$49<sup>99</sup> SET



### THE RECRUIT 1.0 PADDLE

- A recreational, 6-ply bass wood pickleball paddle that features a stained-wood face and a blue handle
- Perfect for the beginner player looking for a solid-feeling pickleball paddle

**90 Day Limited Warranty**

1393482

\$27<sup>99</sup> EA



### THE RECRUIT 2.0 PADDLE

- A recreational, 7-ply baltic birch wood pickleball paddle that features a padded grip on the handle
- Provides a solid feel and long-lasting durability for entry-level players

**90 Day Limited Warranty**

1393483

\$35<sup>99</sup> EA



### THE COMPOSITE STRYKER

- Perfect for players looking to trade up from a wood paddle to a composite
- Offers the lightweight playability of a nomex core with the power of a fiberglass face

**90 Day Limited Warranty**

1460906

Specify Color

\$99<sup>99</sup> EA



### THE GRAPHITE Z5

- The top selling paddle in the Onix line
- Offers the premium, lightweight playability of a graphite face and increased control of a nomex core

**90 Day Limited Warranty**

1460898

Specify Color

\$113<sup>99</sup> EA

## BALLS



### X-40 OUTDOOR PICKLEBALLS

- Meets USA Pickleball approved requirements for outdoor tournament pickleball play
- 40 precisely drilled holes create a balanced consistent flight pattern
- High quality pigments keep the ball visible in various outdoor lighting conditions to help improve accuracy

1460806

Optic Yellow-12 Pack Box

\$39<sup>99</sup> PACK

1460807

Optic Yellow-100 Pack Box

\$249<sup>99</sup> PACK





## ECLIPSE

- The Champion Eclipse Paddle is USAPA approved and weighs a trim 7.3-7.8 oz.
  - Small grip circumference allows it to be handled by players of any size and has cushioned grip that reduces vibration from impact.
  - Handle length is 5".
  - Slim guard to make the most out of the paddles 7 3/4" wide surface
- Color Options: **Blue/Green, Red/Yellow.**

1460994 Specify Color \$49<sup>99</sup> EA



## GRAPHITE X

- The Champion Graphite X Paddle is a colorful model that offers lots of surface area and a responsive gentle feel.
  - Graphite X paddle has a weight range of 7.6-7.8 oz and has a medium circumference grip with perforations to keep sweat away from your hand.
  - The graphite face is great for controlling your placement and the polymer core adds durability and strength.
- Color Options: **Blue, Grey, Purple, Red.**

1460997 Specify Color \$74<sup>99</sup> EA



## PICKLEBALL NET

- Official pickleball height (34") and width (22") net
- Portable, powder-coated steel frame net system
- Center-strap design for consistent height
- Adjustment straps on net edge for excellent net tension
- Fast and easy assembly, with nylon storage bag

1363633 \$229<sup>99</sup> EA



## PICKLEBALL. GREAT FOR ALL AGES!



### DILLER PADDLE

- Lightweight 7-ply maple wood paddle with wrapped handle and safety wrist strap
- From the company that invented the game
- A top choice for recreational and institutional play

1450225 \$19<sup>99</sup> EA



### DILLER PADDLE & BALL PACK

- The Ultimate Starter Kits!
- Durable maple wood pickleball paddles with wrapped grip, safety strap and pickleballs

1450226 2 Paddles + 4 Balls \$32<sup>99</sup> PACK

1450227 4 Paddles + 4 Balls \$55<sup>99</sup> PACK



### DILLER NET SET

- A complete pickleball set for those who have existing net stanchions
- Includes a durable tie-on net (22'L), 4 Diller paddles, 4 pickleballs and a rules/strategy sheet

1024XXXX \$232<sup>99</sup> SET



### 3.0 TOURNAMENT NET & FRAME SET WITH DILLER WOOD PADDLES

- This tournament set includes everything you need to get started playing pickleball
- Includes portable, regulation-size metal frame and net, 4 Diller paddles, 4 pickleballs, carrying bag and rules guide

90 Day Limited Warranty

1364661 \$299<sup>99</sup> SET



PICKLEBALL INC.

# PORTaPiT®

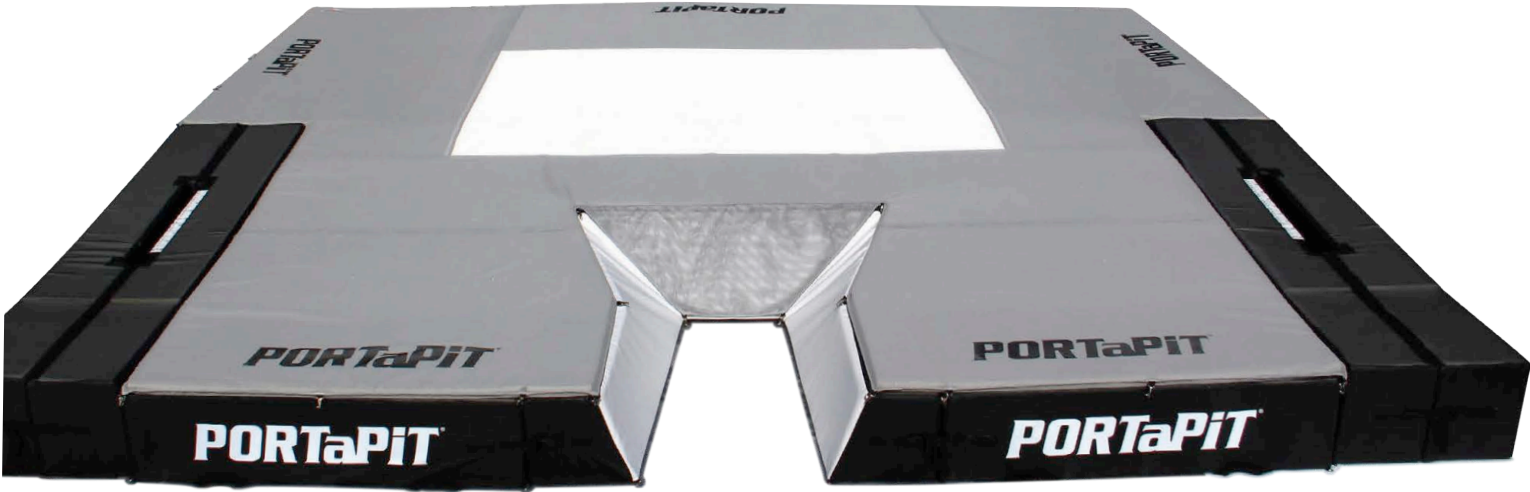

## COMPETITION POLE VAULT LANDING SYSTEM

- Exceeds all High School specifications
- 22'W x 22'L, Pit has 16' 6"D of landing area behind the vault box
- Includes 2" top pad
- Base protector pads sold separately
- Includes 10'W x 8'D coaches box
- All pits made to order with 6-8 week lead time

### OPTIONAL ITEMS

• Base Protector Pads (Required)

#### Competition Pole Vault Landing Systems

GP2222X32	Size: 22"W x 22"L x 32"H	\$19,499 <sup>99</sup>	EA ★
GP2222X28	Size: 22"W x 22"L x 28"H	\$18,499 <sup>99</sup>	EA ★
GP2222X26	Size: 22"W x 22"L x 26"H	\$17,999 <sup>99</sup>	EA ★
GTP2222YDS	Replacement Top Pad	\$4,299 <sup>99</sup>	EA ★

#### Weather Cover

GWC2222X32	32"	\$2,299 <sup>99</sup>	EA ★
GWC2222X28	28"	\$2,299 <sup>99</sup>	EA ★
GWC2222X26	26"	\$2,299 <sup>99</sup>	EA ★

#### Base Protector Pads

STPADCNTL32	32"W x 130"L	\$3,499 <sup>99</sup>	PR ★
STPADCNTL28	28"W x 130"L	\$3,499 <sup>99</sup>	PR ★
STPADCNTL26	26"W x 130"L	\$3,499 <sup>99</sup>	PR ★

**PORTaPiT**  
LANDING SYSTEMS  
AVAILABLE IN:





## SCHOLASTIC POLE VAULT LANDING SYSTEM

- Exceeds High School NFHS specifications
- 20'W x 21'L, Pit has 16' 6" of landing area behind the vault box
- Includes 2" top pad
- Includes 10'W x 8'D Coaches Box
- All pits made to order with a 6-8 week lead time

### OPTIONAL ITEMS

• Base Protector Pads (Required)

#### Scholastic Pole Vault Landing Systems

GP2021X28	Size: 20"W x 21"L x 28"H	\$16,999 <sup>99</sup>	EA ★	
GP2021X26	Size: 20"W x 21"L x 26"H	\$16,499 <sup>99</sup>	EA ★	
GTP2021YDS	Replacement Top Pad	\$3,699 <sup>99</sup>	EA ★	

#### Weather Cover

GWC2021X28	28"	\$1,999 <sup>99</sup>	EA ★
GWC2021X26	26"	\$1,999 <sup>99</sup>	EA ★

#### Base Protector Pads

STPADCTR28	28"W x 107"L	\$2,699 <sup>99</sup>	PAA ★	
STPADCTR26	26"W x 107"L	\$2,699 <sup>99</sup>	PR ★	



### GRAPHICS FOR TOP PADS

- Full color image of your mascot or school name in the center of your top pad
- Please send camera ready art work along with your order and we will a copy of your design for approval
- Please allow an add'l 2 weeks for graphics on a pit order

1459233 Size 6' x 6', for PV or HJ \$359<sup>99</sup> EA ★



**ALL LANDING SYSTEMS  
REQUIRE SAFETY MAX-  
VAULT BOX INSERT.  
SEE PAGE 182-183**

**PORTaPit**  
LANDING SYSTEMS  
AVAILABLE IN:



# GILL™ ATHLETICS

## ESSENTIALS

- All steel tubing construction
- Height adjustment 6' to 16' reading both English and Metric
- Upright detaches for base rails for storage
- 75mm bar rest pins and 8 base anchors included
- Meets NFHS specifications

**GA7100** \$2,199<sup>99</sup> EA



## SCHOLASTIC

- Heavy duty aluminum uprights and rises with custom glide parts
- Weighted steel base includes wheels
- Height scales read in English and Metric from 7' to 18'
- Meets NFHS and NCAA specifications
- 10 Year Limited Warranty

**GA77100** \$1,899<sup>99</sup> PR

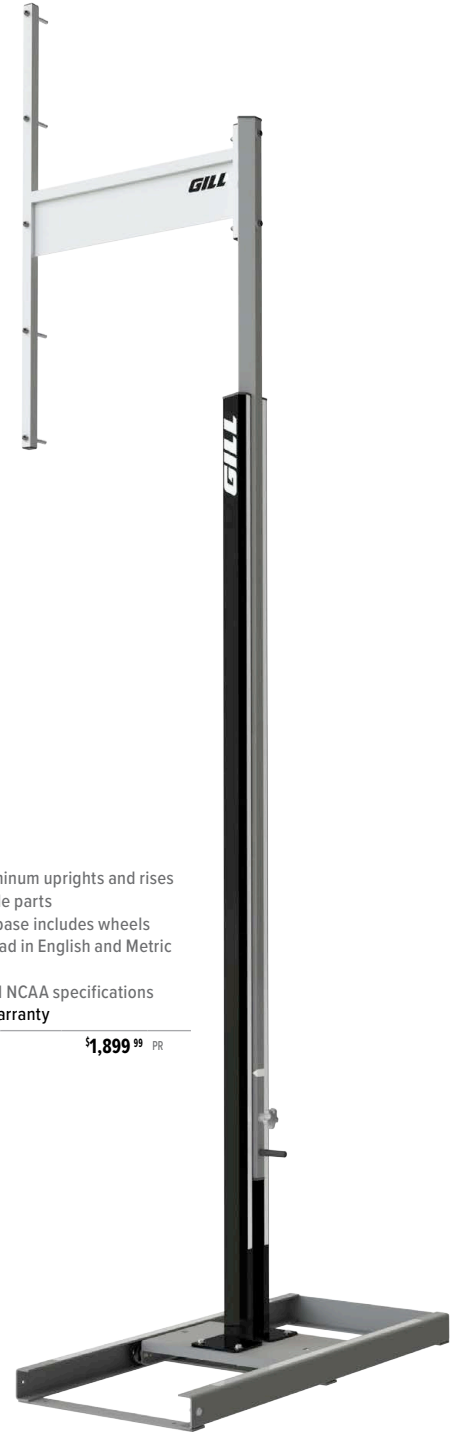

## ELASTIC CROSSBAR

- Elastic practice crossbar with black foam
- Fits both high jump and pole vault

**AFR050BM** \$45<sup>99</sup> EA

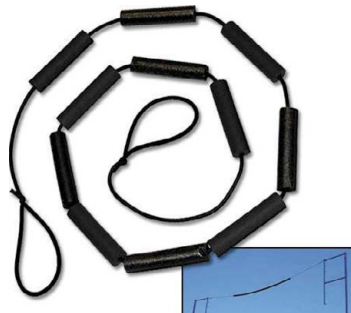

## SAFETY MAX VAULT BOX COLLAR

- Provides additional protection by padding exposed hard surfaces
- Fully compliant with ASTM Standard F2949
- Safety yellow color helps highlight open area for planting and vaulting
- SafetyMax will work with any style of pole vault landing system
- Vault Box is not included with the collar

**GA719** \$839<sup>99</sup> EA 



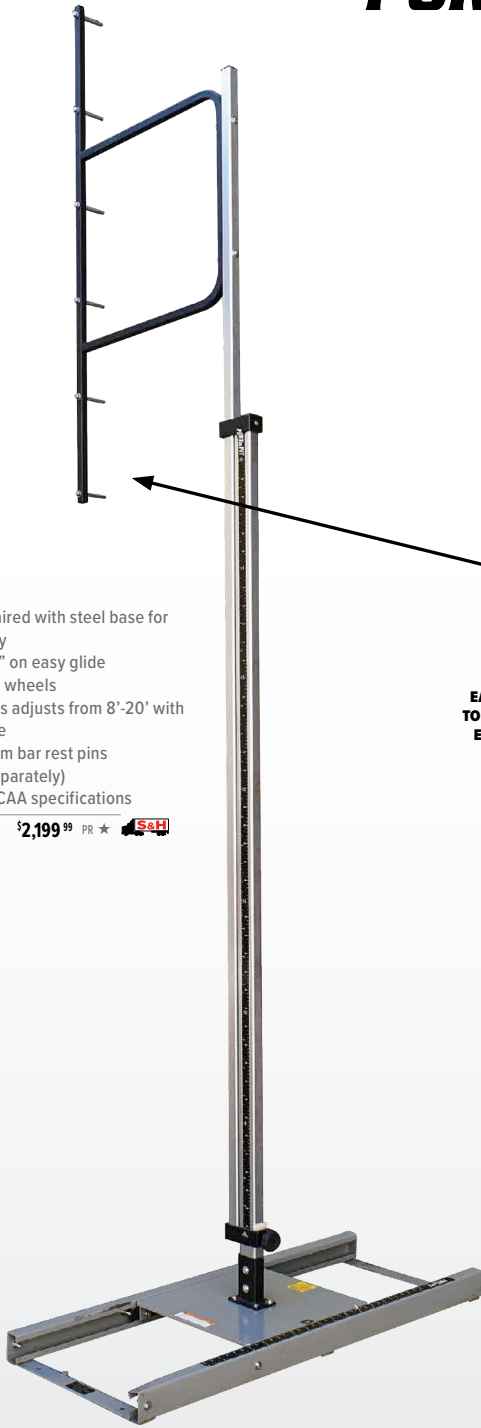

## ELITE

- Aluminum upper paired with steel base for exceptional stability
- Base adjusts 0"-32" on easy glide polyurethane skate wheels
- Detachable uprights adjust from 8'-20' with English/Metric scale
- Equipped with 75mm bar rest pins (55mm pins sold separately)
- Meets NFHS and NCAA specifications

**1378720** \$2,199<sup>99</sup> PR ★



**EASILY ATTACHES TO STANDARDS FOR EXTRA 3' LOWER SETTINGS**



## COMPETITION

- Steel uprights and base are finished with silver powder coat
- Base adjusts 0"-32" on easy glide polyurethane skate wheels
- Detachable upright adjust from 7'-18' marked with English/Metric scale
- Equipped with 75mm bar rest pins (55mm pins sold separately)
- Meets NFHS and NCAA specifications

**1378660** \$1,449<sup>99</sup> PR ★  
**AFEXTEND** Extenders \$112<sup>99</sup> PR ★  
**1378679** 55mm Bar Rest Pins (Set of 12) \$39<sup>99</sup> SET ★



**S&H= \$75<sup>00</sup> PER ORDER (Up to 3 Crossbars)**

## PREMIER PV CROSSBAR

- Pole is 14'10" L
  - Meets Collegiate, International, and NFHS specifications
  - Comes with Nofzinger feature
- 2 Year Limited Warranty**

**AFPV1500** \$89<sup>99</sup> EA ★   
**AFPV1503** Set of 3 \$229<sup>99</sup> SET OF 3 ★



## PUTTER UPPER

- Fits over the end of any vaulting pole

**GA710390** \$31<sup>99</sup> EA ★

## POLE VAULT BOX COLLAR SYSTEM

- Cover is made with heavy duty vinyl
- Made of polyethylene foam filler to meet new ASTM F-2942-12 specifications
- Comes with four (4) in ground anchors
- Fits any pole vault landing system

**1388862** \$599<sup>99</sup> EA ★



# PORTaPit®



## PREMIER HIGH JUMP LANDING SYSTEM

- Meets all High School and NCAA specifications
- Made of 18oz. knife coated polyester fabric
- Includes 2" reversible top pad
- All pits made to order with a 6-8 week lead time

**12 Year Limited Warranty**

GP1116X32	Size: 11' x 16'6" x 32"	\$10,399 <sup>99</sup> EA ★
GWC1016X32	Weather Cover	\$749 <sup>99</sup> EA
GP1116X28	Size: 11' x 16'6" x 28"	\$9,499 <sup>99</sup> EA ★
GWC1016X28	Weather Cover	\$749 <sup>99</sup> EA
GP1116X24	Size: 11' x 16'6" x 24"	\$8,999 <sup>99</sup> EA ★
GWC1016X24	Weather Cover	\$749 <sup>99</sup> EA
GTP1016XDS	Replacement Top Pad	\$2,199 <sup>99</sup> EA ★



## GRAPHICS FOR TOP PADS

- Full color image of your mascot or school name in the center of your top pad
- Please send camera ready art work along with your order and we will a copy of your design for approval
- Please allow an add'l 2 weeks for graphics on a pit order

1459233 Size 6' x 6', for PV or HJ \$359<sup>99</sup> EA ★

CODE	OVERALL SIZE	3 BASE UNITS	TOP PAD	WEIGHT
GP1016X32	11' X 16'6" X 32"	11' X 16'6" X 30"	11' X 16'6" X 2"	650 LBS
GP1016X28	11' X 16'6" X 28"	11' X 16'6" X 26"	11' X 16'6" X 2"	550 LBS
GP1016X24	11' X 16'6" X 24"	11' X 16'6" X 22"	11' X 16'6" X 2"	450 LBS

## ELEMENTARY HIGH JUMP PIT

- Ideal for elementary physical education classes
- Created and designed for the younger athlete
- Meets our own rigorous safety standards
- This pit does not require a top pad

**5 Year Limited Warranty**

GBU24511	5'6" x 11' x 24"	\$3,699 <sup>99</sup> EA ★
GBU30511	5'6" x 11' x 30"	\$4,199 <sup>99</sup> EA ★



**PORTaPit®**  
LANDING SYSTEMS  
AVAILABLE IN:



# PORTaPIT®



**12**  
YEAR LIMITED WARRANTY

NEW  
REVERSIBLE  
TOP PAD

**24" and 28"**  
HEIGHT  
OPTIONS

CODE	OVERALL SIZE	3 BASE UNITS	TOP PAD	WEIGHT
GP0816X28	8' x 16'6" x 28"	5'6" x 8' x 26"	8' x 16'6" x 2"	550-LBS
GP0816X24	8' x 16'6" x 24"	5'6" x 8' x 22"	8' x 16'6" x 2"	450-LBS

## SCHOLASTIC HIGH JUMP LANDING SYSTEM

- Meets all High School and NCAA specifications
  - Made of 18 oz. knife coated polyester fabric
  - Includes 2" top pad
  - All pits made to order with 6-8 week lead time
- 5 Year Limited Warranty**

GP0816X28	Size: 8' x 16'6" x 28"	\$6,999 <sup>99</sup> EA ★	
GWC0816H	Weather Cover	\$699 <sup>99</sup> EA ★	
GP0816X24	Size: 8' x 16'6" x 24"	\$6,499 <sup>99</sup> EA ★	
GWC0816M	Weather Cover	\$699 <sup>99</sup> EA ★	
GTP0816XDS	Replacement Top Pad	\$1,699 <sup>99</sup> EA ★	



**12**  
YEAR LIMITED WARRANTY

NEW  
REVERSIBLE  
TOP PAD

**24" and 28"**  
HEIGHT  
OPTIONS

CODE	OVERALL SIZE	3 BASE UNITS	TOP PAD	WEIGHT
GP1218X28	12' x 18' x 28"	6' x 12' x 26"	12' x 18' x 2"	750-LBS
GP1218X24	12' x 18' x 24"	6' x 12' x 22"	12' x 18' x 2"	680-LBS

## COMPETITION HIGH JUMP LANDING SYSTEM

- Meets all High School and NCAA specifications
  - Made of 18 oz. knife coated polyester fabric
  - Includes 2" top pad
  - All pits made to order with 4-6 month production time (depending on product availability)
- 5 Year Limited Warranty**

GP1218X28	Size: 12' x 18' x 28"	\$10,999 <sup>99</sup> EA ★	
GWC1218H	Weather Cover	\$1,249 <sup>99</sup> EA ★	
GP1218X24	Size: 12' x 18' x 24"	\$10,499 <sup>99</sup> EA ★	
GWC1218M	Weather Cover	\$1,249 <sup>99</sup> EA ★	
GTP1218XDS	Replacement Top Pad	\$1,899 <sup>99</sup> EA ★	

# GILL™ ATHLETICS

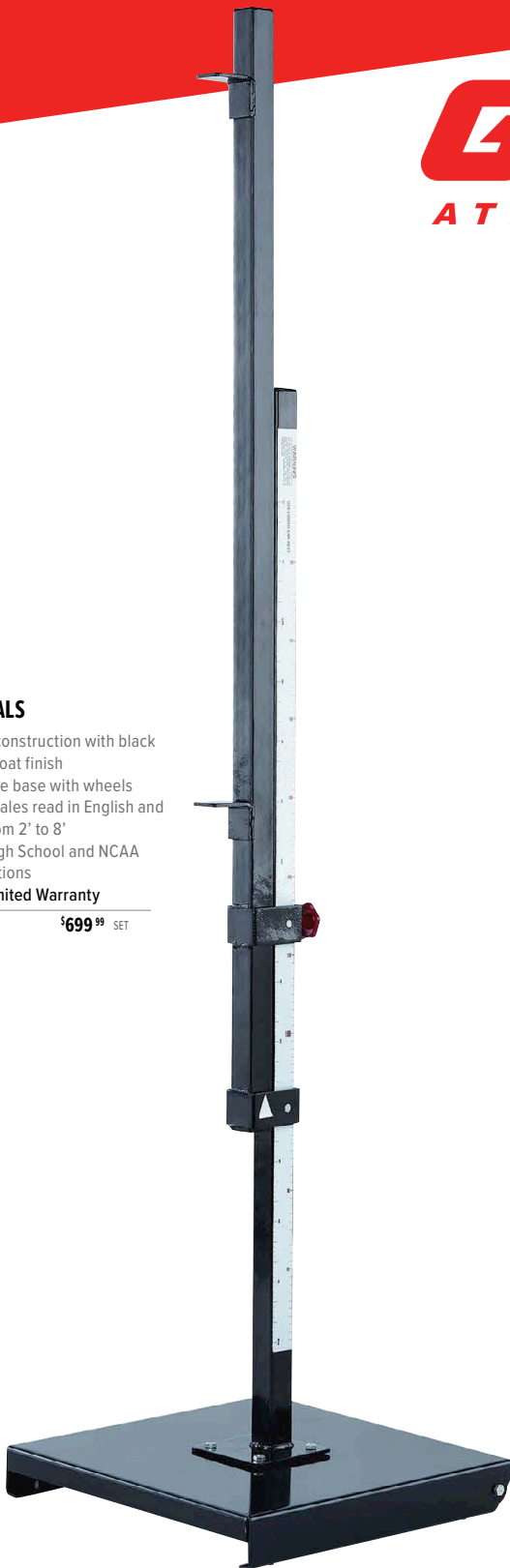

## ESSENTIALS

- All steel construction with black powder coat finish
- 18" square base with wheels
- Height scales read in English and Metric from 2' to 8'
- Meets High School and NCAA specifications

10 Year Limited Warranty

**GA700** \$699<sup>99</sup> SET



## S4 SCHOLASTIC

- Heavy duty aluminum uprights and rises with custom glide parts
- Weighted steel base includes wheels
- Height scales read in English and Metric from 2' to 7'4"
- Meets NFHS and NCAA specifications

10 Year Limited Warranty

**GA78105** \$1,399<sup>99</sup> PR 

## WOOD DECK PIT CART

- Constructed of 3/4" MDO exterior plywood
- Cart deck measures 4' x 8'
- 12" pneumatic wheels for easy maneuverability
- Deck height is 16"

**GA767** \$1,879<sup>99</sup> EA 



## ESSENTIALS CROSSBARS

<b>GA522</b>	High Jump	\$89 <sup>99</sup> EA
<b>GA5223</b>	HJ- Set of 3	\$229 <sup>99</sup> EA
<b>GA523</b>	Pole Vault	\$89 <sup>99</sup> EA
<b>GA5233</b>	PV- Set of 3	\$229 <sup>99</sup> EA



# PORTaPIT®

## COMPETITION

- Steel uprights and 18" base are finished with silver powder coat
- Adjusts from 2'-8" marked with English/Metric scale
- Meets NFHS and NCAA specifications

**1378658** \$549<sup>99</sup> PR ★



## ELITE

- Aluminum uppers paired with steel base for exceptional stability
- Low profile base is equipped with wheels for easy transport
- Height adjustments for 2' - 8'6" with English/Metric scale
- Meets NFHS and NCAA specifications

**1378710** \$849<sup>99</sup> PR ★

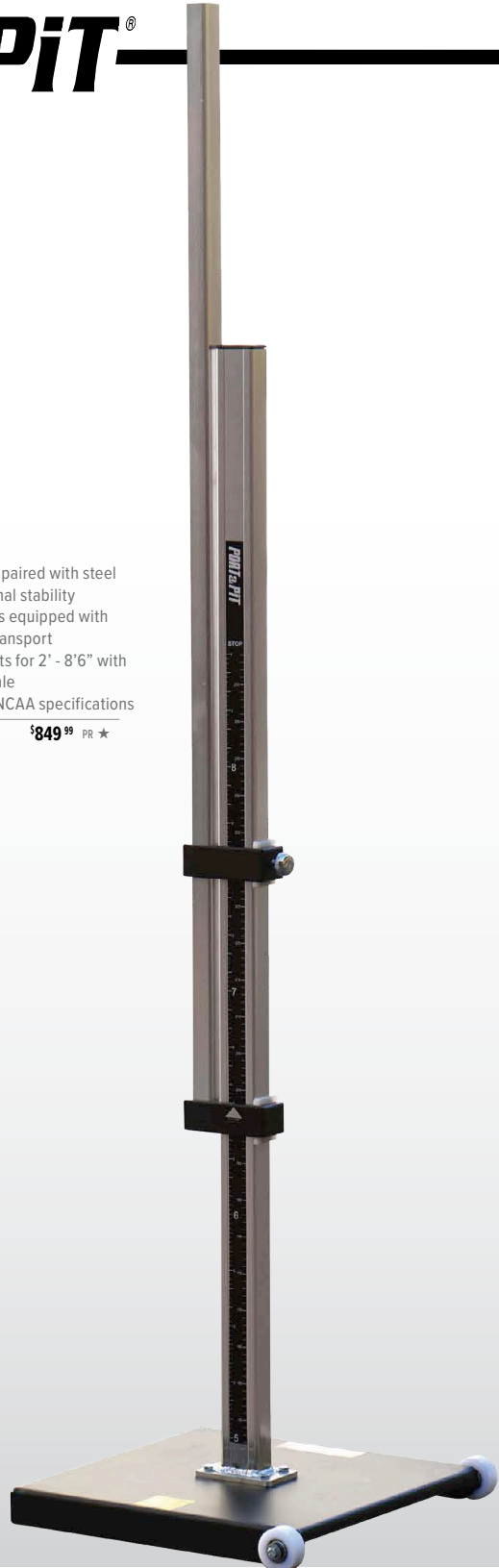

## PREMIER HJ CROSSBAR

- Pole is 13' 1 1/2"
- Meets collegiate, international, and NFHS specification
- 2 Year Limited Warranty

**AFHJ1500** \$89<sup>99</sup> EA ★   
**AFHJ1503** Set of 3 \$229<sup>99</sup> SET ★ 

S&H= \$75<sup>00</sup> PER ORDER (Up to 3 Crossbars)

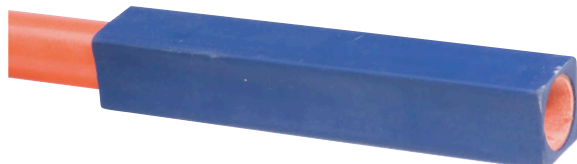

# HURDLES



## ELITE HIGH SCHOOL

- The standard for elite high school track programs
- All aluminum square tube construction with welded cross support
- Meets official high school pullover requirements at 30", 33", 36", 39" and 42"
- Meets high school specifications
- Ships assembled

GA402

Specify Color

\$449<sup>99</sup> EA



## HIGH SCHOOL

- Powder coated steel U-shaped single cross support design
- Weighted base and Lexan gateboard
- 41" hurdle adjustable to 30", 33", 36", 39" and 42"
- Meets high school specifications

GA403

Specify Color

\$299<sup>99</sup> EA



## PORTaPiT<sup>™</sup> TRAINING HURDLE

- Galvanized Steel lower and Anodized Aluminum upper
- Upper and Lower Nylon Gates breakaway with ease
- Four height adjustments 30", 33", 36", 39"
- 40"W x 19"D x 76"H 23 lbs
- Available November 2018

1453174

\$249<sup>99</sup> EA ★



## FLIGHT HURDLE CART

- Sturdy steel construction with black powder coated finish
- Four wheel design provides superior moveability
- Designed for "L" shaped hurdles only
- Holds 8-10 hurdles

GA4630

\$599<sup>99</sup> EA ★



## HURDLE TRANSPORT CART

- Steel construction with durable black powder coated finish
- Large swivel casters for easy transportation
- Compatible with both rocker and "L" shaped hurdles
- Holds 15-20 hurdles

GA4020

1459232 Hurdle Cart Cover, please specify Graphics

\$1,199<sup>99</sup> EA ★

\$449<sup>99</sup> EA





### FOAM TRAINING HURDLE

- Lightweight foam training hurdle with carrying handle
- Tough vinyl shell allows for indoor and outdoor use
- Adjustable to 30" 33" 36" and 39" heights

**90 Day Limited Warranty**

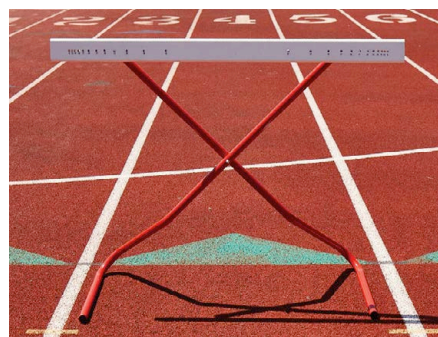
1454088 \$229<sup>99</sup> EA ★



## PORTaPiT<sup>™</sup> X-TRAINER

- Ideal hurdle for plyometrics, speed, and agility.
- Adjusts from 6" to 42"
- Inexpensive style for beginners to use
- Hurdle folds flat for easy transport and storage

1274509

\$79<sup>99</sup> EA ★



## PORTaPiT<sup>™</sup> JUNIOR TRAINING

- Lightweight all anodized aluminum construction
- Includes PVC hurdle board and nylon breakaway gate with hook-and-loop grip
- Rocker design will automatically right itself
- Instant locking at 5 heights: 22", 24", 26", 28" and 30"
- Weight: 10 lbs.

AJEVXXXX  
AVELCROS

Nylon Breakaway Gates

\$99<sup>99</sup> EA ★

\$7<sup>99</sup> EA ★



### ADVANTAGE

- Meets NFHS and NCAA specifications
- Strong high quality mill finish aluminum
- Concealed EZ glide weights to meet official pullover standards

GAAADVA Specify Riser Color \$339<sup>99</sup> EA ★



### ELITE

- Meets NFHS, NCAA and IAAF specifications
- Strong high quality mill finish aluminum
- EZ glide weight presets lock in for precise pullover

GAAFRLH Specify Riser Color \$379<sup>99</sup> EA ★



### STANDARD HURDLE BOARD PRINTING

Standard printing on boards, 1-color with block lettering

GA945 59 Hurdles or Less/per order \$50<sup>00</sup> PER ORDER

### CUSTOM HURDLE BOARD PRINTING

Custom printing on boards, up to 4-colors with logo

GA946 59 Hurdles or Less/per order \$95<sup>00</sup> PER ORDER

### FREE OFFER!!

Buy 60 hurdles or more and we will place custom lettering on the hurdle board at no charge. Put your mascot or event title on your hurdles! No set-up fee. Please supply your artwork: Call for info: 1-800-527-7510



### COMPETITION ROCKER

- Meets NFHS specifications
- Lightweight, high quality anodized aluminum alloy
- Impact absorbing PVC gateboard

GAHSRX Specify Riser Color \$269<sup>99</sup> EA ★



### HIGH SCHOOL ALUMINUM

- Meets NFHS specifications
- Lightweight, high quality anodized aluminum alloy
- Impact absorbing PVC gateboard

GAAFURY Specify Riser Color \$199<sup>99</sup> EA ★





### PYRAMID SPIKES

BAG OF 100

**AASPKP18**  
**AASPKP14**  
**1098273**



1/8"  
 1/4"  
 3/16"

**\$19.99** PACK OF 100  
**\$19.99** PACK OF 100  
**\$19.99** PACK OF 100

### NEEDLE SPIKES

BAG OF 100

**AASPKN18**  
**AASPKN14**  
**1098280**



1/8"  
 1/4"  
 3/16"

**\$19.99** PACK OF 100  
**\$19.99** PACK OF 100  
**\$19.99** PACK OF 100

### T-HANDLE SPIKE WRENCH

• For easily removing and tightening your spikes

**GA846**

**\$17.99** EA



### RELAY BATONS

- Lightweight anodized aluminum baton
- Features smooth rolled-in edges and non-slip ground finish
- Official size

Color Options: Green, Red, Blue, Gold, Silver, Black, Purple.

**AALBAT**  
**APLBATONPK**

Aluminum Baton **\$6.99** EA ★  
 Yellow (plastic) - Pack of 6 **\$11.99** PACK OF 6 ★



### PORTaPIT<sup>®</sup> INDOOR STARTING BLOCKS

- Non-slip, poly-blocks make it easy to practice indoors during inclement weather
- Simply apply pressure to blocks with foot and blocks provide the athlete with non-slip starts indoors

**6036XXXX**

**\$72.99** PR ★

### SPIKE KIT

Includes a variety of spikes plus a T-handle spike wrench. Extra dividers are included in each spike kit to maximize your storage options of up to 13 compartments  
 Storage Case: 14.5" x 9.75" x 2.25"

- 3 bags of 1/8" Pyramid
- 2 bags of 3/16" Pyramid
- 2 bags of 3/16" Needle
- 2 bags of 3/8" Pyramid
- 2 bags of 1/4" Needle
- 1 Gill Storage Case

**GA850**

**\$249.99** EA



### STARTING BLOCK CART

- All steel construction with quality blue enamel finish and easy rolling
- Holds 10 blocks and has storage for spikes and accessories.
- 10" x 2 3/4" wheels

**20010511**

**\$468.99** EA ★



# PORTaPIT®

## STARTING BLOCKS

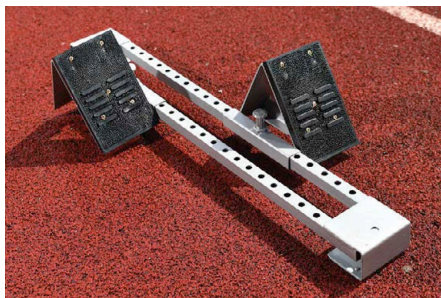

### COMPETITION

- All steel components
- Spring loaded plunger for pedal adjustment and secure locking
- Complete with spikes for all surface types

**ASB2000S**

\$149<sup>99</sup> EA ★

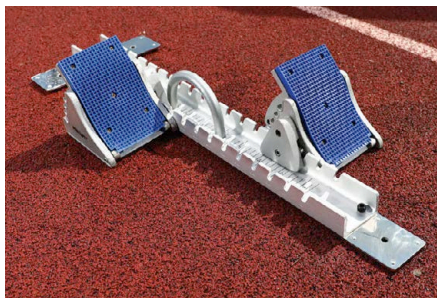

### PREMIER

- Cast aluminum, 4-angle wide adjustable pedals
- Durable polished aluminum chrome rail
- Block measures: 12.5"W x 33"L
- Complete with spikes for all surface types

**ASB4500X**

\$259<sup>99</sup> EA ★

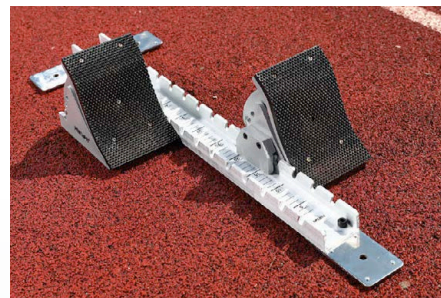

### ELITE

- Cast aluminum, 4-angle wide adjustable pedals
- Durable aluminum rail
- Block measures: 12"W x 35"L
- Complete with spikes for all surface types

**ASB3500X**

\$199<sup>99</sup> EA ★

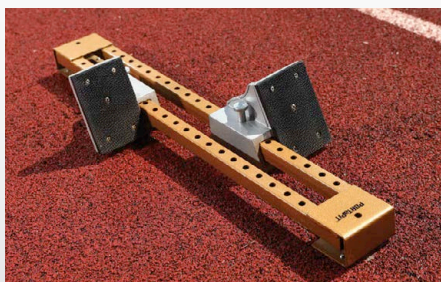

### SCHOLASTIC

- Steel double rail with cast pedals and plunger adjustment
- Great for middle and high school programs
- Complete with spikes for all surface types

**ASB1500X**

\$123<sup>99</sup> EA ★

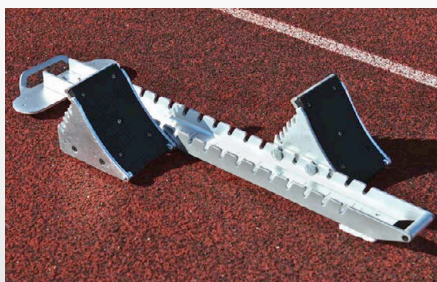

### ULTIMATE

- All aluminum construction
- 5-angle adjustable pedals
- IAAF certified and comes with 15mm spikes
- Easy to grab handle

**ASB5000X**

\$269<sup>99</sup> EA ★

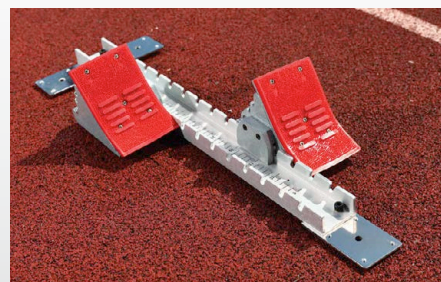

### ELITE II

- Cast aluminum, 4-angle adjustable pedals
- Durable aluminum rail
- Block measures: 11"W x 30"L
- Complete with spikes for all surface types

**ASB3000**

\$179<sup>99</sup> EA ★

# GILL

ATHLETICS



### FUSION 4

- Standard 4" x 8" pedals
- Meets NFHS, NCAA and IAAF specifications, IAAF certified
- Color Options: Black, Dark Green, Orange, Red, Royal Blue.

**GA730181C**

Specify Pedal Color

\$629<sup>99</sup> EA

### FUSION 10

- Exclusive 8 x 10" pedal allows full heel support for the best starts
- Precise and consistent foot placement is ensured using intergrated pedal markings
- Angled spikes in base of pedals guarantee no slipping during explosive starts
- Built in handle allows for easy carriage between locations
- Pedals adjust to 30°, 40°, 50°, 60°
- Meets NFHS, NCAA and IAAF specifications, IAAF certified
- Color Options: Black, Dark Green, Orange, Red, Royal Blue.

**GA730183C**

Specify Pedal Color

\$799<sup>99</sup> EA

### FUSION 8

- Exclusive 8" x 8" pedals designed for a more aggressive acceleration pattern
- Meets NFHS, NCAA and IAAF specifications, IAAF certified
- Color Options: Black, Dark Green, Orange, Red, Royal Blue.

**GA730182C**

Specify Pedal Color

\$749<sup>99</sup> EA

### AVAILABLE COLORS

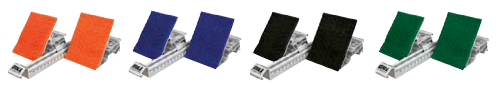

# DISCS



## VIBE

- Mid-Spin discus
- ABS plastic side plates
- High quality steel rim
- Meets NFHS, NCAA and World Athletics specifications

<b>GAVIBE10</b>	75% Rim Weight-1K	\$137 <sup>99</sup> EA
<b>GAVIBE16</b>	75% Rim Weight-1.6K	\$149 <sup>99</sup> EA



## S SERIES

- Low-Mid spin with exclusive, high impact translucent side plates
- High quality steel rim
- Meets NFHS, NCAA and World Athletics specifications

<b>GA75810</b>	58% Rim Weight-1K Pink	\$89 <sup>99</sup> EA
<b>GA76116</b>	61% Rim Weight-1.6K Electric Green	\$104 <sup>99</sup> EA
<b>GA76720</b>	67% Rim Weight-2K Electric Green	\$119 <sup>99</sup> EA



## HOLLOWOOD STAR

- Recommended for all levels
- Straight grained hard rock maple side plates
- High quality steel rim, up to 75% rim weight
- Meets High School, NCAA, and IAAF specifications

<b>GA300</b>	2K	\$449 <sup>99</sup> EA
<b>GA305</b>	1.6K	\$429 <sup>99</sup> EA
<b>GA313</b>	1K	\$399 <sup>99</sup> EA



## S SERIES

- High quality steel rim
- Colorful, high impact translucent plates
- Meets NFHS, NCAA and World Athletics specifications

<b>GA77510</b>	75% Rim Weight-1K Aqua	\$102 <sup>99</sup> EA
<b>GA77516</b>	75% Rim Weight-1.6K Cobalt Blue	\$119 <sup>99</sup> EA
<b>GA77520</b>	75% Rim Weight-2K Cobalt Blue	\$142 <sup>99</sup> EA



## S SERIES

- High quality steel rim
- Colorful, high-impact translucent side plates
- Meets NFHS, NCAA and World Athletics specifications

<b>GA77810</b>	78% Rim Weight-1K Galaxy Purple	\$114 <sup>99</sup> EA
<b>GA78016</b>	80% Rim Weight-1.6K Volcano Red	\$129 <sup>99</sup> EA
<b>GA78020</b>	80% Rim Weight-2K Volcano Red	\$172 <sup>99</sup> EA



## G SERIES

- High-moment G-Series offers throwers precision crafted discus
- High-spin steel alloy rim
- Meets NFHS, NCAA and World Athletics specifications
- World Athletics certified

<b>GA88110</b>	81% Rim Weight-1K Zircon Red	\$209 <sup>99</sup> EA
<b>GA88316</b>	81% Rim Weight-1.6K Zircon Red	\$249 <sup>99</sup> EA
<b>GA88320</b>	81% Rim Weight-2K Zircon Red	\$279 <sup>99</sup> EA

## PORTaPiT<sup>®</sup> GOLD LO-SPIN

- Silver Medal winner at the 1996 Games in Atlanta
- Designed for beginner and intermediate throwers
- Constructed of High-impact ABS plastic side plates with a steel rim
- 75% rim weight
- Meets NFHS specifications



<b>ADLSHSGD</b>	1.6K	\$78 <sup>99</sup> EA ★
<b>ADLS1KGD</b>	1K	\$78 <sup>99</sup> EA ★

## PORTaPiT<sup>®</sup> CHALLENGER DISCUS

- Plastic plated discus
- Priced for general purposes practice or dual meet competition
- 73% rim weight
- Meets NFHS specifications



<b>1101386</b>	1.6K	\$64 <sup>99</sup> EA ★
<b>1101393</b>	1K	\$61 <sup>99</sup> EA ★

## PORTaPiT<sup>®</sup> WOOD

- Economy wood discus with steel rim
- Ideal for competition as well as practice
- 60-70% rim weight
- Meets NFHS specifications



<b>1101409</b>	2K	\$64 <sup>99</sup> EA ★
<b>1101416</b>	1.6K	\$59 <sup>99</sup> EA ★
<b>1101423</b>	1K	\$46 <sup>99</sup> EA ★

## PORTaPiT<sup>®</sup> BLACK RUBBER - OFFICIAL

- Molded to the official weight and specs
- Recommended for practice and official competition
- Meets NFHS specifications



<b>1101430</b>	2K	\$24 <sup>99</sup> EA ★
<b>1101447</b>	1.6K	\$19 <sup>99</sup> EA ★
<b>1101454</b>	1K	\$18 <sup>99</sup> EA ★

## PORTaPiT<sup>®</sup> BLACK RUBBER - PRACTICE

- Affordable hard rubber discus
- Excellent for training at the high school or middle school level.



<b>ARD1.6XX</b>	1.6K	\$12 <sup>99</sup> EA ★
<b>ARD1.0XX</b>	1K	\$11 <sup>99</sup> EA ★

# PORTaPIT®



## BRASS

- Lathe turned to minimum diameter allowed in competition
- Machine finished for excellent grip and calibrated to exact weight
- Unsurpassed quality
- Meets all Collegiate, International & High School Federation specifications

**ABSHOT12** 115mm 12lbs \$164.99 EA ★

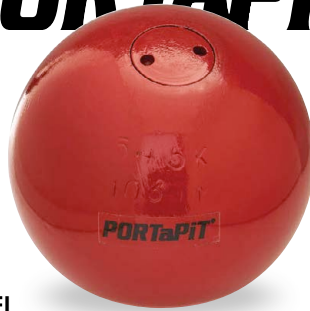

## STEEL

- Solid steel shot for the advanced thrower
- Machine turned to different diameters
- Lathe turned and balanced for an overall best performance
- Polyurethane paint coated for smooth and durable finish
- Meets NFHS specifications

**1101508** 103mm 12lbs \$104.99 EA ★



## TURNED IRON

- Solid cast iron shot
- Machine turned to different diameters
- Balanced for high performance throws
- Meets NFHS specifications

**AFSHOT16** 16 lbs-Blue \$114.99 EA ★

**AFSHOT12** 12 lbs-Silver \$86.99 EA ★

**AFSHOT4K** 4K-Red \$79.99 EA ★

**BSN SPORTS**

### GYM CHALK

- For weight-lifting or gymnastics
- Conveniently wrapped in 2 oz. blocks
- Eight blocks per 1 lb. package

**PGE4360X** \$28.99 LB ★

**Gym Chalk**

*Magnesium Carbonate*

One Pound



## SCHOLASTIC

- Cast iron weight shot
- Great for high school/middle school practice
- Priced to fit your budget

**ARSHOT12** 12 lbs \$39.99 EA ★

**ARSHOT4K** 4K \$38.99 EA ★

**1101591** 8 lbs \$39.99 EA ★

**1101614** 6 lbs \$39.99 EA ★



## INDOOR

- High visibility red indoor shot has that outdoor shot feel
- Soft enough not to mark or damage the gym or indoor facility floor
- Designed for training purposes only, not certified for competition.

**6048XXXX** 4K \$69.99 EA ★

**6082XXXX** 12lb 5.44K \$79.99 EA ★

Gender	Age	Hammer	Shot Put	Discus	Javelin
Girls	<10		6#		*
Girls	11-12		6#	1.0K	*
Girls	13-14		6#	1.0K	600gr
HS Girls	15-16	4K	4K	1.0K	600gr
HS Girls	17-18	4K	4K	1.0K	600gr
Collegiate Women		4K	4K	1.0K	600gr

Gender	Age	Hammer	Shot Put	Discus	Javelin
Boys	<10		6#		*
Boys	11-12		6#	1.0K	*
Boys	13-14		4K	1.0K	600g
HS Boys	15-16	12#	12#	1.6K	800g
HS Boys	17-18	12#	12#	1.6K	800g
Collegiate Men		16#	16#	2.0K	800g

## PORTaPIT®

### IMPLEMENT CART

- Constructed of 1" square heavy wall steel tube finished with Gray Hammertone Powder Coated finish
- Holds 12 discus, 7 Javelin, 15 Shots, can also be used for Hammers
- Transports load easily on 10" solid rubber wheels and 4" swivel Casters
- 40"L x 24"W x 37"H 64 lbs
- Available November 2018

**1453173** \$549.99 EA ★



### SHOT AND DISCUS CARRIER

- Water resistant polyester carrier holds two discus, two shots or one of each
- Comes with shoulder strap for easy transport

**ASDCXXXX** \$19.99 EA ★

## DISCUS/SHOTS CIRCLES

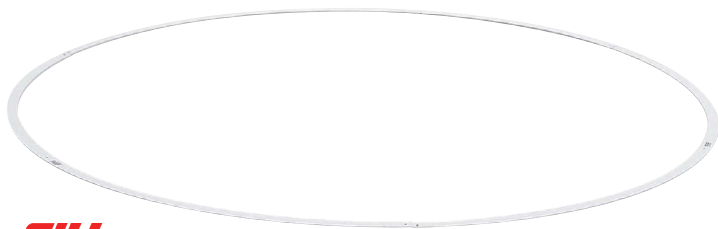

### STEEL DISCUS CIRCLE

- Three sections of 1/4" x 1 1/2" flat powder coated steel
- Designed to be mounted on top of concrete surface
- Anchor bolts included
- Meets NFHS specifications

GA371

\$949<sup>99</sup> EA



### ALUMINUM CIRCLES

- Four sections of 1" x 3/4" extruded aluminum angle
- Designed to be cast into concrete
- Discus circle can also be mounted to surface
- Compatible with toeboards GA358, GA363
- Meets NFHS, NCAA and IAAF specifications

GA369

Shot/Hammer

\$429<sup>99</sup> EA



GA370

Discus

\$429<sup>99</sup> EA



### STEEL SHOT CIRCLE

- Four sections of 1/4" x 1 1/2" flat powder coated steel
- Designed to be mounted on top of concrete surface
- Anchor bolts included
- Compatible with toeboards GA359, GA364
- Meets NFHS specifications

GA373

\$599<sup>99</sup> EA



## TOE BOARDS



### SYNTHETIC SHOT TOEBOARD

- Molded low density polyethylene designed for 3/4" depressed surface
- Compatible with circles GA369
- Meets NFHS, NCAA and IAAF specifications

GA358

For Depressed Pad

\$549<sup>99</sup> EA

GA359

For Level Pad

\$549<sup>99</sup> EA



### ALUMINUM SHOT TOEBOARD

- Cast aluminum designed for a 3/4" depressed surface
- Compatible with circles GA369
- Meets NFHS, NCAA and IAAF specifications

GA363

For Depressed Pad

\$899<sup>99</sup> EA



GA364

For Level Pad

\$899<sup>99</sup> EA







**PRO DOWN DISCUS CAGES**

- Consists of six galvanized 2 3/8"OD, 12 gauge steel upright poles
- Five galvanized steel top rungs helps eliminate neg sag
- The knotless weather treated nylon net has a breaking strength of 180 lbs.
- Comes with ground sleeves, Net Height: 10' 6"

<b>GA80401</b>	Cage with Ground Sleeves	<b>\$2,899<sup>99</sup></b> EA	
<b>GA80402</b>	Cage with Plates	<b>\$4,499<sup>99</sup></b> EA	
<b>GAM2003</b>	Replacement Net	<b>\$1,759<sup>99</sup></b> EA	



**HIGH SCHOOL PORTABLE DISCUS CAGE**

- Designed for set up or removal as needed
- Poles: (6) 6063-T6 aluminum net poles
- Net is #504 knotless nylon with 180 lb breaking strength
- Net height: 13' 6"
- Bases: A500 Grade B steel with wheels for transportability and weighted with 5 gallon jugs to be filled with sand or water

<b>GA732220</b>	Cage	<b>\$13,499<sup>99</sup></b> EA	
<b>GAM2055</b>	Cage Net	<b>\$1,299<sup>99</sup></b> EA	

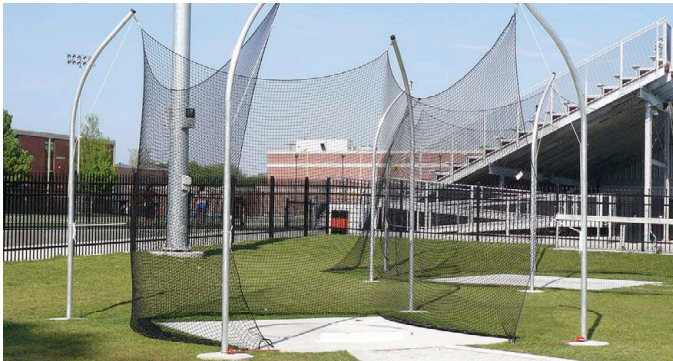

**SHOT CAGE**

- Poles: (4) 6063-T6 aluminum or A513 steel
- Net is weather treated nylon 6 net with 180 lb breaking strength
- Net height: 13' 6"
- 18" hinged net arms secure net at front two poles with ground stakes used at back poles
- 20" deep ground sleeves

<b>GA8050</b>	Aluminum Cage	<b>\$4,599<sup>99</sup></b> EA	
<b>GA805</b>	Steel Cage	<b>\$3,999<sup>99</sup></b> EA	
<b>GAM2054</b>	Cage Net	<b>\$1,099<sup>99</sup></b> EA	



**COMPETITION 13' 6" DISCUS CAGE**

- All aluminum high school discus cage with 6 permanent in-ground sleeves and 4" square posts.
- Comes complete with sleeve caps.
- Meets High School specification.
- Special pulley system allows easy daily removal of netting.
- 30" cantilever post for Offset netting provides for maximum protection.
- Net is 1-3/4" weather treated nylon with weighted bottom.
- Includes spectator warning signs.

**4 Year Limited Warranty**

<b>AHSDCAGE</b>		<b>\$4,599<sup>99</sup></b> EA ★	
<b>SNHSDNET</b>	Replacement Net-13'H x 54'L	<b>\$659<sup>99</sup></b> EA ★	

Replacement Net-13'H x 54'L



**HIGH SCHOOL DISCUS CAGE**

- Aluminum poles: 2 7/8" outside diameter with rolled offset for safety
- Steel poles: 2 1/2" square A513 with rolled offset for safety
- Net: 180 lb breaking strength
- Net height: 13' 6"
- Meets NFHS specifications

<b>GA8010</b>	6-Pole Cage-Aluminum	<b>\$4,999<sup>99</sup></b> EA	
<b>GA8030</b>	6-Pole Cage-Steel	<b>\$4,699<sup>99</sup></b> EA	
<b>GAM2055</b>	Cage Net	<b>\$1,299<sup>99</sup></b> EA	
<b>GA80102</b>	Barrier Netting for Alum Cage	<b>\$699<sup>99</sup></b> EA	
<b>GA80302</b>	Barrier Netting for Steel Cage	<b>\$699<sup>99</sup></b> EA	

## VAULT BOXES



**GILL**  
ATHLETICS

### ALUMINUM VAULT BOX

- Welded aluminum construction
- Meets High School and NCAA specifications
- IAAF certified

GA502 \$849<sup>99</sup> EA



**GILL**  
ATHLETICS

### SLIDING VAULT BOX

- Sliding vault box allows vaulters to perfect the run, plant, and take-off
- Pole carriage, run mechanics, tempo, and step placement are more effectively learned using this training tool
- Constructed of high impact thermoplastic, same size as regular vault box
- To be used as a training aid, not to be used as vault box in meets

GA2531 \$824<sup>99</sup> EA

## MEASURING WHEELS

### FIBERGLASS MEASURING TAPES

- Durable, long-lasting, vinyl-coated fiberglass tapes in ABS shatter resistant case
- Closed reel tapes feature an easy to wind, flush-folding handle
- Open reel tapes feature easy to wind return, handle and shoulder strap
- Printed with inches/feet on one side and centimeters/meters on the other
- Includes end-loop for one-person measuring



1. <b>MSTAP50X</b>	50'-15M	\$25 <sup>99</sup> EA ★
2. <b>MSTAP100</b>	100'-30M	\$31 <sup>99</sup> EA ★
3. <b>MSTAP165</b>	165'-50M	\$38 <sup>99</sup> EA ★
4. <b>MSTAP200</b>	200'-60M	\$48 <sup>99</sup> EA ★
5. <b>MSTAP330</b>	330'-100M	\$77 <sup>99</sup> EA ★

### ELECTRONIC MEASURING WHEEL

- This electronic wheel has a steel frame to make the sturdiest electronic wheel
- Easy-to-read digital counter is in the most protected spot of wheel
- Designed to NEMA Class II standards, not be damaged by the rain
- Display backlit 7-digit display for low-light usage, up to 99,999 ft or tenths and metric, Counter requires 2AA batteries(not included)

GA9701 \$419<sup>99</sup> EA



## TAKE OFF BOARDS



### ARCHED JUMP BOX

- A convex jumping box made of lightweight steel
- Covered in synthetic track material so your athletes have the same feeling as the runway or high jump apron
- 8" high in the middle by 30" wide by 47" long

GATA193 \$849<sup>99</sup> EA

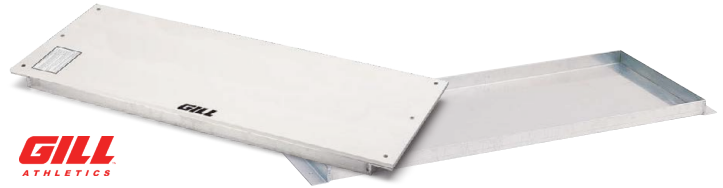

**GILL**  
ATHLETICS

### HIGH SCHOOL TAKE-OFF BOARD

- Complete system: Installation tray, aluminum base board, and reversible take-off board
- Made of synthetic material for longer lifespan
- Meet NFHS specifications

GA441TS Complete HS System \$899<sup>99</sup> EA  
GA44105 Replacement 19.5" Take Off Board \$299<sup>99</sup> EA



### 100 FT. PENNANT STREAMER

- Rope streamers with 18" nylon cloth pennants in a variety of colors: Blue, Green, Red, White and Yellow
- Use to dress up your field, crowd control or for cross-country events
- Sold in lengths of 100' (approx. 48 flags per 100')

1260XXXX Streamers \$25<sup>99</sup> EA ★

### ECONOMY MEASURING WHEEL

- Lightweight and extremely durable
- Measures in English up to 10,000 feet
- Handle folds down for easy storage

1378131 \$199<sup>99</sup> EA ★





### TIMERS AND JUDGES STAND

- Holds 10 people seated or 20 people standing
- Five rows of 48" long steps
- Rail support along the back for safety
- Red enamel finish, with galvanized seats, footrests, and backrest
- Easy mobility provided by 8" diameter wheels on back

GA995 \$1,799<sup>99</sup> EA



### ROLLOUT RUNWAY

- Our 10mm rollout runway installs in seconds with no bonding necessary.
- Solve your runway problems and protect your track
- Available in 48" width.
- Roll up after use for easy transportation and storage.

AFRUM10M \$6<sup>49</sup> SQ.FT



### LANDING ZONE<sup>®</sup> PIT COVERS

- Landing Zone ballasted pit protectors keeps sand in...even in high winds, but keeps cats and kids out.
- Steel chain edge hem all around keeps protector down in high winds.
- All units are made to the specific size ordered.
- Pit will **not** stay dry in the event of rain!
- Add 2' to each dimension so the protector extends over the pit and onto the track.
- Colors: Black, Dk Green, Maroon, Navy, Red, Royal, Orange, White, Yellow

1298017 Vipol<sup>®</sup> Matrix Material \$5<sup>99</sup> SQ.FT  
 1298024 Vinyl Polyester Material \$5<sup>99</sup> SQ.FT

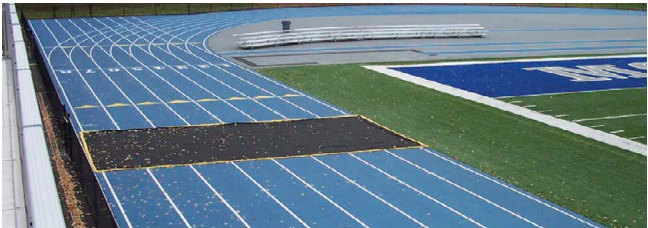

### CROSS-OVER ZONE<sup>®</sup> TRACK PROTECTOR

- Made with a tough, durable polypropylene non-woven fabric
- Entire edge is vinyl wrapped with internal steel chain weighting, making it wind-proof (No stakes required)
- Easy-to-install temporary cover, resists and cushions against steel-tipped football cleats, yet allows rain to drain through
- Saves modern track materials from damaging cleats and other traffic
- Color: Black with Gold or White edging

1248326	7.5'W x 30'L	\$739 <sup>99</sup> EA	
1248333	7.5'W x 40'L	\$899 <sup>99</sup> EA	
1248340	7.5'W x 50'L	\$1,024 <sup>99</sup> EA	
1248296	15'W x 30'L	\$1,049 <sup>99</sup> EA	
1248302	15'W x 40'L	\$1,249 <sup>99</sup> EA	
1248319	15'W x 50'L	\$1,449 <sup>99</sup> EA	
1248357	Custom Size - 420 sqft Minimum Per Piece	\$3 <sup>39</sup> SQ.FT	



### ALUMINUM MAINTENANCE RAKE

- All aluminum construction
- Durable and lightweight with oversized teeth for easy field grooming & pit maintenance
- Use one side to rake and the other side to level
- 58" long handle

1196238	Size - 24"W	\$109 <sup>99</sup> EA ★
1196245	Size - 36"W	\$124 <sup>99</sup> EA ★
1196252	Size - 48"W	\$132 <sup>99</sup> EA ★



### THREE PLACE AWARD STAND W/ GRAPHICS

- Three Place Award Stand for 1st, 2nd, 3rd Place
- Made of 18 oz coated vinyl, high density foam
- 72"L x 24"W x 23"H
- Please allow 3-4 weeks for delivery

1459231 Please specify graphics \$1,144<sup>99</sup> EA ★

### 4 DIGIT PERFORMANCE INDICATOR

- Aluminum construction with steel roll away base
- 9" tall numerals
- Rotates 360 degrees
- Powder coated in a gloss black

GA79100 \$1,299<sup>99</sup> EA



### 2 DIGIT LAP COUNTER W/ BELL

- Aluminum construction with steel roll away base, with bell
- 9" tall numerals
- Rotates 360 degrees
- Powder coated in a gloss black

GA79300 \$899<sup>99</sup> EA





### ECONOMY STOPWATCH

- Single event watch
- 1/100 second precision with lap counter (1st 30 minutes)
- Beep, beep alarm with chime and snooze
- 12/24 hour display option
- Count up to 23 hrs, 59 min., 59 sec.
- Detachable lanyard

**1266702** Black \$12<sup>99</sup> EA ★  
**1266696** 6 Color Pack \$64<sup>99</sup> PACK OF 6 ★



### 106L STOPWATCH

- Single events and time outs
- Cumulative splits, 1-2 Fast Finish
- 1/100 second with lap
- Daily alarm and hourly chime

**1269062** Black \$14<sup>99</sup> EA ★  
**1269079** 8 Color Pack \$86<sup>99</sup> PACK OF 8 ★



## ACCUSPLIT

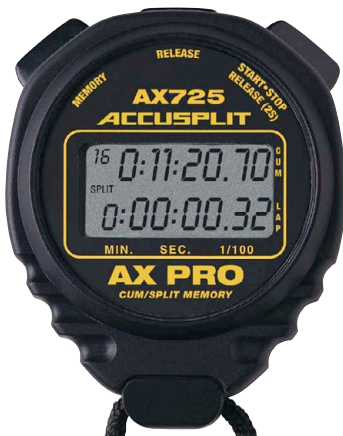

### AX725 STOPWATCH

- 16 Dual split memory
- Dual split (lap & cum)
- 1 Button rapid split and reset
- 10 hour range
- Water resistant
- 5-year battery life
- 5 Year Limited Warranty

**MSSTP725** \$29<sup>99</sup> EA

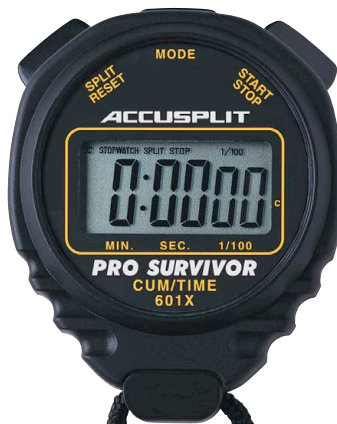

### 601X STOPWATCH

- Times single event and cumulative splits
- Large digits for easy viewing
- 1-2 fast finish, 30 minute range
- 5 year "no proof" warranty
- 5-year battery life

**12440191** \$22<sup>99</sup> EA



**NEW!**

### HALO STARTING DEVICE

- 12 total LED lights that wrap around both sides of the device so that the starters can see the flash clearly from afar
- Sounds both a tone and bang sound
- Connects wirelessly to the Gill Wireless Starter System
- Features an audio jack for compatibility with existing speaker systems
- Compatible with FinishLynx and other FAT systems
- Powered by one 9V battery
- Includes: Halo Device, Protective Carrying Case, Audio cable, Timing System cable, 9V battery, Phillips head screwdriver
- Complete Wireless System includes: Halo Device, 50 watt speaker(+90dB) plus durable tripod

**GAE49710** Starting Device Only \$299<sup>99</sup> EA  
**GAE49720** Complete Wireless Starting System \$1,569<sup>99</sup> EA

# Robic



## Robic SC-500E STOPWATCH

- One-step timing for all events
- Start/stop/reset operation
- Water resistant to 30 meters
- Audible beep confirmation or silent operation

1378161

\$26<sup>99</sup> EA



## Robic SC-505W STOPWATCH

- 12 Memory Chrono
- Time events up to 24 hours in 1/100 second resolution
- 12 Memory recall
- Automatic lap count to 199

MSSTP505

Black \$32<sup>99</sup> EA

1240283

6 Color Pack \$199<sup>99</sup> SET

1451079

Red \$37<sup>99</sup> EA

1451080

Yellow \$37<sup>99</sup> EA

1451081

Blue \$37<sup>99</sup> EA

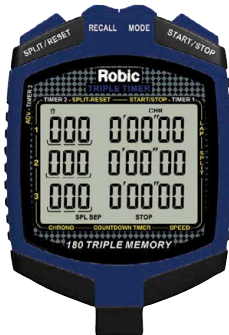

## Robic SC-899 SPEED AND SPORT TIMER

- 180 Dual memory recall capacity and a total reading capacity of 1000 times
- Use the memory without interrupting timing
- Water resistant design, time of day, alarm, and calendar

1452988

\$55<sup>99</sup> EA



## 1000W DUAL STOP WATCH W/COUNT DOWN TIMER

- Single Event-Lap or Split Timing to 10 hours
- 1/100 second precision Countdown Timer
- Track 2 activities Using the stopwatch and Countdown simultaneously
- Water Resistant—Soft Rubber grips offer Comfort
- Prism pack includes one each Blue, Green, Orange, Purple, Red and Yellow

1399652

Black Only \$27<sup>99</sup> EA

1399651

6 Color Pack \$149<sup>99</sup> PACK

# ULTRAK

## 499 STOPWATCH & PRINTER

- Stopwatch system with a portable printer
- 500 lap dual memory that stores lap and cumulative times
- Events are kept in memory segmented by date and run number; all data can be printed out or printed after event
- Dual countdown timer and automatic split release

5 Year Limited Warranty

MSSTP499SP

\$399<sup>99</sup> EA

MSSTPP25

EXTRA PRINTER PAPER ROLLS-Box of 25

\$59<sup>99</sup> BOX OF 25



## 360 STOPWATCH

- 30 dual splits recallable memory
- Lap/cumulative splits
- Recalls times forwards/backwards
- Measures to 10 hours, time and calendar, alarm, lithium battery

3 Year Limited Warranty

1151824

\$34<sup>99</sup> EA



## 340 STOPWATCH

- Display of cumulative splits
- Large numerical display
- Time, calendar, alarm
- Water resistant; lithium battery

3 Year Limited Warranty

1151830

\$22<sup>99</sup> EA



## L10 8-LANE TIMER

Road Race (Cross Country) Mode

- 8,000 memory for individual finishers in single or multiple events
- Four digit bib numbers, four digit place counter
- Bib number entry at finish or add/edit after event
- Automatic print out during event
- Single and multiple start times, up to 99 waves in multiple start race

Track Race Mode

- 8 lap/split lane buttons
- Linkgate allows single wire to lane timer
- 8,000 dual split memory for single or multiple events
- Four digit bib numbers

Automatic printout of date, run number and record type

1151794

\$949<sup>99</sup> EA



## 495 STOPWATCH

- 100 dual split recallable memory
- Takes splits from within recall mode
- Time, calendar and alarm
- Water resistant; lithium battery

5 Year Limited Warranty

1188271

\$62<sup>99</sup> EA



## S149 STOPWATCH/PRINTER SYSTEM

- Measurable up to 10 hours in 1/100 of a second
- Store and recall of up to 300 split/lap times
- Memory segregated by event
- Multiple event memory
- Memory recall during operation

1380581

\$549<sup>99</sup> EA





NFHS APPROVED

**SPALDING**  
**TF-VB5**

- Select Japanese leather cover
- 2-ply soft cloth lining inside
- Floating butyl bladder
- Indoor use only

**WCVB5** Specify Color \$78<sup>99</sup> EA  
**WC721258** White \$78<sup>99</sup> EA

ADDITIONAL COLOR OPTIONS



NFHS APPROVED

**SPALDING**  
**TF-VB3**

- Tournament microfiber composite leather cover
- Floating butyl bladder
- V-Seam construction

**WCVB3** Specify Color \$55<sup>99</sup> EA

ADDITIONAL COLOR OPTIONS



**NEW!**  
**molten**  
**FLISTATEC**

- FLISTATEC Flight Stability Technology
- Premium microfiber composite cover
- Indoor use only

Color Options: FIVB, NCAA, USAV.

**1462208** Specify Color \$82<sup>99</sup> EA



NFHS APPROVED

NFHS APPROVED

**molten**  
**SUPER TOUCH**

- Premium Japanese leather cover
- Uni-bladder cotton wrapped construction
- NFHS approved

**1461864** Specify Color \$80<sup>99</sup> EA



**molten**  
**SUPER TOUCH-NCAA**

- Premium Japanese leather cover
- Uni-bladder cotton wrapped construction
- Official volleyball of the NCAA® Women's Championships

**1273656** \$80<sup>99</sup> EA



**molten**  
**L2 COMPOSITE**

- Microfiber composite
- Uni-bladder cotton wrapped construction
- Indoor use only

**1455044** Specify Color \$49<sup>99</sup> EA

NFHS APPROVED

ADDITIONAL COLOR OPTIONS



NFHS APPROVED

**TACHIKARA**  
**SV-5WM LEATHER**

- Perfect value for practice in team white or team colors
- Full Grain Leather cover
- Indoor use only

**1371299** Specify Color \$54<sup>99</sup> EA





**NEW!**



**ALL AMERICAN**

- Premium composite leather
- Approved by AVCA
- Indoor use only

1460103 Specify Color \$69<sup>99</sup> EA



**LEXUM**

- Soft microfiber cover
- Ideal tack to create maximum control
- Indoor use only

1460693 Specify Color \$54<sup>99</sup> EA

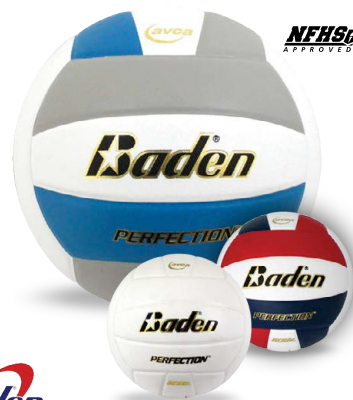

**PERFECTION®**

- Top-Grade leather cover
- Total Feel Technology™
- Indoor use only

1460094 Specify Color \$74<sup>99</sup> EA



**SV-5W GOLD LEATHER**

- U.S. Premium leather cover
- Patented Dual Bladder Construction (DBC™) for a more responsive and controlled touch
- Impact reducing air layer buffers and evenly disperses force of digs, passes and spikes
- Indoor use only

TACSV5WX White \$79<sup>99</sup> EA  
1050912 Red/White/Blue \$79<sup>99</sup> EA



**SV-5WS "SENSI-TEC"™ COMPOSITE**

- Sensi-Tec™ micro-fiber composite leather cover
- Patented Loose Bladder Construction (LBC™)
- Hand finished panels and seams
- Indoor use only

TACSV5WS White \$52<sup>99</sup> EA



**SV-5WSC "SENSI-TEC"™ COMPOSITE**

- All colors are NFHS approved
- Indoor use only

1072266 Specify Color \$52<sup>99</sup> EA



**K1 SILVER**

- Internal command lining enables players to evoke more power and velocity
- Durable composite leather cover made to last
- Soft feel for intense training sessions
- Indoor use only

WLWTH1895B Specify Color \$54<sup>99</sup> EA



**K1 GOLD**

- Durable leather cover
- Command lining for powerful kills with control
- Responsive feel for perfect touches
- Indoor use only

WLWTH1895A Specify Color \$74<sup>99</sup> EA



**NEW!**

**Mikasa**  
**VFC1000**

- Cotton core construction
- Premium Japanese leather cover
- True Shape Accu-Balance Technology
- Indoor use only

1460977 Specify Color \$69<sup>99</sup> EA



**NEW!**

**Mikasa**  
**VQ2000**

- Competition game ball with micro-cell composite cover
- True Shape Accu-Balance Technology
- Indoor use only

1459597 Specify Color \$49<sup>99</sup> EA



**MARK 1 VOLLEYBALL**

- Japanese cordley composite leather cover
- Microfiber backing for soft touch feel
- Floating bladder
- Indoor use only

1235593 \$49<sup>99</sup> EA ★

**TOURNAMENT TESTED!**



**MacGregor**  
**X660 SOFT TOUCH**

- Full grain cowhide leather cover
- Competition game ball
- True balance technology
- Indoor use only

**2 Year Limited Warranty**  
MCV660WH \$59<sup>99</sup> EA ★



**MacGregor**  
**X1000 GAME COMPOSITE**

- Soft composite leather cover
- Floating bladder construction
- Available in 7 colors
- Indoor/Outdoor use

MCV1000W Specify Color \$45<sup>99</sup> EA ★



**MacGregor**  
**X600 COMPOSITE**

- HQ Composite leather cover
- Soft touch technology
- Floating bladder
- Indoor use only

**2 Year Limited Warranty**  
MCV600WH \$36<sup>99</sup> EA ★



BSNSPORTS

**YMCA HERITAGE VOLLEYBALL**

- Soft touch high quality composite leather cover
- Official size and weight

1384328 \$39<sup>99</sup> EA ★



**SV-18S COMPOSITE**

- Woven-fiber v100 composite
- Single Unit Construction (SUC)
- Indoor use only

1233124 \$42<sup>99</sup> EA

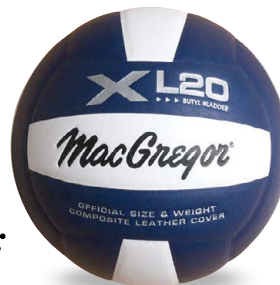

**MacGregor**  
**XL20 COMPOSITE**

- Composite leather cover
- Exclusive shape retention bladder
- Indoor use only

**2 Year Limited Warranty**  
MCVL20WH Specify Color \$32<sup>99</sup> EA ★



**Wilson**  
**SOFT PLAY**

- Machine sewn with synthetic leather cover
- Excellent air and shape retention
- Indoor use only

1014167 \$25<sup>99</sup> EA



# TRAINING BALLS

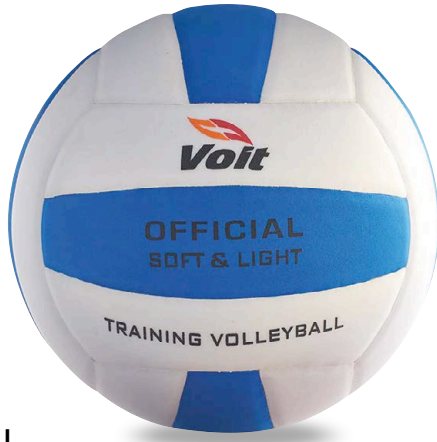

## Voit

### SOFT TRAINING VOLLEYBALL

- Soft and light training volleyball
- Regulation size but lighter weight for beginners
- Indoor use only

1392604 Royal \$23.99 EA ★



**NEW!**

## molten®

### VB-U12

- Soft microfiber composite cover
- Official size and lightweight
- USYVL approved
- Indoor use only

1462197 Specify Color \$49.99 EA



## Voit

### LIGHT SPIKE

- Double knit soft polyester fabric cover allows players to practice skills without discomfort
- 30% lighter than official volleyball
- Ideal trainer for developing fundamentals safely

1342536 \$17.99 EA ★



## Voit

### BUDGET VOLLEY TRAINER®

- Sponge-like vinyl cover
- 18% larger and 12% lighter than an official volleyball
- Economical training ball

VVBBUDVT Blue/Yellow \$22.99 EA ★  
1297911 Red/Yellow \$22.99 EA ★



## TACHIKARA®

### TB-18 "THE SETTER"™

- Sensi-tec® micro-fiber composite cover
- Weighted ball builds hand/finger strength
- Weight: 15.7 - 17.5 oz.
- Indoor use only

1091991 \$56.99 EA



## Voit

### V5 RUBBER COVER

- Molded composition rubber cover
- Nylon wound bladder
- Indoor/Outdoor use

VV5HXXX \$10.99 EA ★



## TACHIKARA®

### VOLLEY-LITE®

- Sensi-Tec® microfiber composite cover
- Regulation size but lighter weight for younger players
- Helps develop novice players skills faster
- Indoor use only

20011575 White \$45.99 EA  
1050905 Scarlet/White/Royal \$45.99 EA  
1155549 Additional Colors \$49.99 EA

#### ADDITIONAL COLOR OPTIONS





**Voit**

**CV4 "SOFT SHOT" STINGLESS**

- "Sting-free" Syn-Tec™ rubber cover
- Special foam coating makes it durable and soft
- Indoor/Outdoor use
- 2-year Limited Warranty

**VCV4HXXX** \$20<sup>99</sup> EA ★

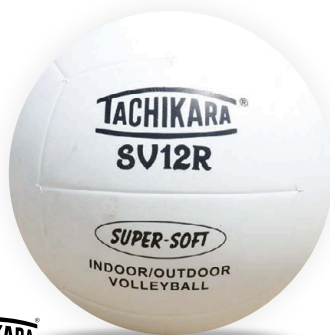

**TACHIKARA**

**SV12R "SUPER-SOFT"™**

- "Super-Soft"™ rubber cover preferred by younger players
- Nylon-yarn winding provides extra durability
- Indoor/Outdoor use

**TACSV12R** \$23<sup>99</sup> EA

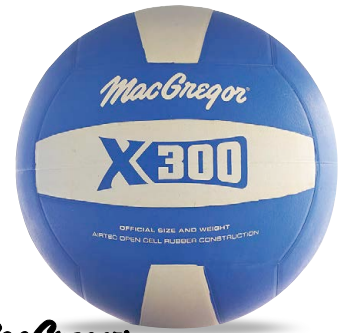

**MacGregor**

**X300 RUBBER COVER**

- Airtec Open Cell molded rubber cover allows for a thicker rubber without additional weight
- Smoother and softer feel with increased gripability
- Indoor/Outdoor use

**1272772** \$16<sup>99</sup> EA ★



**Voit**

**V5RWB RUBBER COVER**

- Molded composition rubber cover
- Nylon wound bladder
- Indoor/Outdoor use

**1272765** \$13<sup>99</sup> EA ★



**Voit**

**SANDSTORM II**

- PU synthetic cover
- Machine sewn panel construction
- Indoor/Outdoor use

**1297935** \$28<sup>99</sup> EA ★



**Voit**

**SANDSTORM**

- Soft, synthetic leather cover
- Machine sewn panel construction
- Indoor/Outdoor use

**1262650** \$20<sup>99</sup> EA ★



**molten**

**BV5000**

- Ultimate playability and superior touch
- Hand-stitched soft polyurethane cover
- Official size and weight

**1462205** Specify Color \$59<sup>99</sup> EA



**molten**

**V5B5000**

- FIVB approved Official beach
- Polyurethane cover machine stitched
- Outdoor use

**1455065** \$59<sup>99</sup> EA



**Wilson**

**OPTX**

- Enhanced ball tracking
- Superior spin detection
- Official game ball

**WLWTH0020XB** \$79<sup>99</sup> EA



SCARLET



BLACK

NAVY

• SEE ADDITIONAL BALL CARTS ON PG 260.



**HAMMOCK BALL CART**

- Tubular galvanized steel frame
- Low profile design makes it easy to turn, reach & spike
- Collapsible unit that stores in carry bag (Included)
- Holds 24 balls
- 48”L x 22”W x 12”D x 40”H - 13 lbs.

1155389 Specify Color \$239<sup>99</sup> EA



**HAMMOCK VB CART**

- Galvanized steel construction
- Cart folds up and stores away in a carry bag (included)
- Lightweight and easy to move around the court
- Holds 24 balls

1454525 40”H x 24”W x 24”D \$219<sup>99</sup> EA ★

**MESH BALL CARRIER**

- Comes with shoulder strap, vinyl bottom and mesh top fabric

1235654 22”H x 28”W \$45<sup>99</sup> EA ★



**VOLLEYBALL CARRY BAG**

- 9” x 50” black polyester with shoulder strap and strong metal zipper
- Holds 6 volleyballs
- Available in Black only

MSVBAGTB \$44<sup>99</sup> EA ★



**E-Z FOLD CART**

- Aluminum square frame
- Nylon top with mesh bottom
- Holds 20 basketballs or 30 volleyballs
- Non-marring swivel casters
- Folds to only 6” wide for easy storage

MCVBCARTY 40”H x 24”W x 24”D \$159<sup>99</sup> EA ★



**MANUAL SCOREKEEPER WITH ADJUSTABLE STAND**

- 7” numbers printed on vinyl
- Scores up to 99 for each team
- Two erasable team panels
- PVC stand measures 38”H with a 15” x 15” base
- Converts from floor model to 12”H table top unit

1162448 \$99<sup>99</sup> EA ★



**MANUAL TABLETOP DOUBLE SIDED SCOREBOARD**

- 6” numbers for scoring
- 2.5” numbers to score games (0-5 for each side)
- Scores up to 30 for each team
- Double-sided, see the score from front and back
- Folds up for easy transport and storage

MSMLTSCR 7”H x 15”W \$79<sup>99</sup> EA ★



**PORTABLE MANUAL SCOREKEEPER**

- 6” score digits
- 2.5” Period/Games digit up to 5
- Scores game up to 99 for each side
- No assembly required
- Lays flat for storage

1196177 11”H x 23”W \$79<sup>99</sup> EA ★

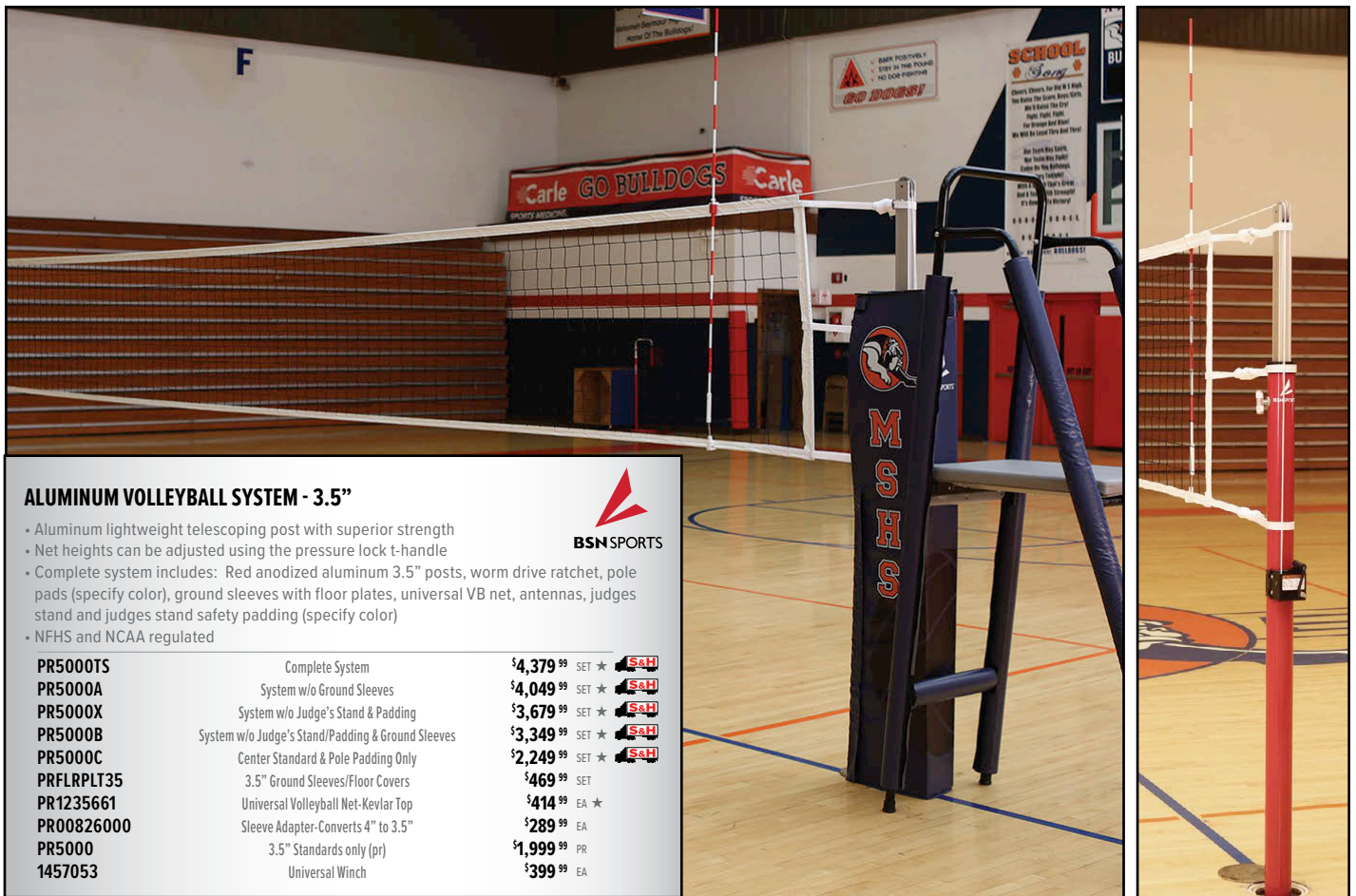

### ALUMINUM VOLLEYBALL SYSTEM - 3.5"



- Aluminum lightweight telescoping post with superior strength
- Net heights can be adjusted using the pressure lock t-handle
- Complete system includes: Red anodized aluminum 3.5" posts, worm drive ratchet, pole pads (specify color), ground sleeves with floor plates, universal VB net, antennas, judges stand and judges stand safety padding (specify color)
- NFHS and NCAA regulated

PR5000TS	Complete System	\$4,379 <sup>99</sup>	SET	★	
PR5000A	System w/o Ground Sleeves	\$4,049 <sup>99</sup>	SET	★	
PR5000X	System w/o Judge's Stand & Padding	\$3,679 <sup>99</sup>	SET	★	
PR5000B	System w/o Judge's Stand/Padding & Ground Sleeves	\$3,349 <sup>99</sup>	SET	★	
PR5000C	Center Standard & Pole Padding Only	\$2,249 <sup>99</sup>	SET	★	
PRFLRPLT35	3.5" Ground Sleeves/Floor Covers	\$469 <sup>99</sup>	SET		
PR1235661	Universal Volleyball Net-Kevlar Top	\$414 <sup>99</sup>	EA	★	
PR00826000	Sleeve Adapter-Converts 4" to 3.5"	\$289 <sup>99</sup>	EA		
PR5000	3.5" Standards only (pr)	\$1,999 <sup>99</sup>	PR		
1457053	Universal Winch	\$399 <sup>99</sup>	EA		

### PAD COLOR OPTIONS



BSN SPORTS		VOLLEYBALL SYSTEMS-AT-A-GLANCE							
X INDICATES THE FEATURE IS INCLUDED WITH THE SYSTEM									
CODE	PRICE	U/M	RATCHET	ANTENNA	POLE PADS	NET	JUDGES STAND	JUDGES STAND PAD	GROUND SLVS/ FLOOR PLATES
<b>ALUMINUM 3.5" OD</b>									
PR5000TS	\$4,379 <sup>99</sup>	SET	X	X	X	X	X	X	X
PR5000A	\$4,049 <sup>99</sup>	SET	X	X	X	X	X	X	
PR5000X	\$3,679 <sup>99</sup>	SET	X	X	X	X			X
PR5000B	\$3,349 <sup>99</sup>	SET	X	X	X	X			
<b>HYBRID 3" OD</b>									
PR4000TS	\$3,839 <sup>99</sup>	SET	X	X	X	X	X	X	X
PR4000A	\$3,649 <sup>99</sup>	SET	X	X	X	X	X	X	
PR4000X	\$3,199 <sup>99</sup>	SET	X	X	X	X			X
PR4000B	\$2,979 <sup>99</sup>	SET	X	X	X	X			
<b>STEEL 3.5" OD</b>									
PR3000TS	\$3,399 <sup>99</sup>	SET	X	X	X	X	X	X	X
PR3000A	\$3,049 <sup>99</sup>	SET	X	X	X	X	X	X	
PR3000X	\$2,799 <sup>99</sup>	SET	X	X	X	X			X
PR3000B	\$2,409 <sup>99</sup>	SET	X	X	X	X			

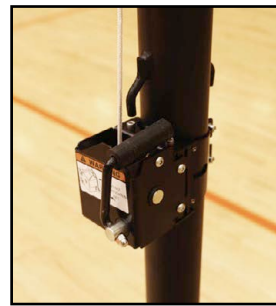

### HYBRID VOLLEYBALL SYSTEM - 3"

- Heavy duty steel outer upright with aluminum inner upright
- Telescoping standard with pin-stop preset heights
- Flat black powder coated finish
- Complete system includes: Flat black steel outer/aluminum inner 3" posts, worm drive ratchet, pole pads (specify color), ground sleeves with floor plates, universal VB net, antennas, judges stand and judges stand safety padding (specify color)
- NFHS and NCAA regulated



PR4000TS	Complete System	\$3,839 <sup>99</sup>	SET ★	
PR4000A	System w/o Ground Sleeves	\$3,649 <sup>99</sup>	SET ★	
PR4000X	System w/o Judge's Stand & Padding	\$3,199 <sup>99</sup>	SET ★	
PR4000B	System w/o Judge's Stand/Padding & Ground Sleeves	\$2,979 <sup>99</sup>	SET ★	
PR4000C	Center Standard/Pole Padding Only	\$1,759 <sup>99</sup>	SET ★	
PR1235661	Universal Volleyball Net-Kevlar Top	\$414 <sup>99</sup>	EA ★	
PRFLRPLT30	3" Ground Sleeves/Floor Covers	\$469 <sup>99</sup>	SET	
PR00827300	Sleeve Adapter-Converts 3.5" to 3"	\$299 <sup>99</sup>	EA	
PR4000	3" Standards only (pr)	\$1,949 <sup>99</sup>	PR	
1457053	Universal Winch	\$399 <sup>99</sup>	EA	

### PAD COLOR OPTIONS



### STEEL VOLLEYBALL SYSTEM - 3.5"

- Heavy duty galvanized steel stationary uprights
- Chrome powder coated black gloss collars slide up/down for height adjustment
- Multi-sport system can be used for volleyball, tennis, or badminton
- Complete system includes: Flat grey galvanized steel 3.5" posts, worm drive ratchet, pole pads (specify color), ground sleeves with floor plates, universal VB net, antennas, judges stand and judges stand safety padding (specify color)
- NFHS regulated



PR3000TS	Complete System	\$3,399 <sup>99</sup>	SET ★	
PR3000A	System w/o Ground Sleeves	\$3,049 <sup>99</sup>	SET ★	
PR3000X	System w/o Judge's Stand & Padding	\$2,799 <sup>99</sup>	SET ★	
PR3000B	System w/o Judges Stand/Padding or Ground Sleeves	\$2,409 <sup>99</sup>	SET ★	
PR3000C	Center Standard/Pole Padding Only	\$1,589 <sup>99</sup>	SET ★	
PRFLRPLT35	3.5" Ground Sleeves/Floor Covers	\$469 <sup>99</sup>	SET	
PR1235661	Universal Volleyball Net-Kevlar Top	\$414 <sup>99</sup>	EA ★	
PR00826000	Sleeve Adapter-Converts 4" to 3.5"	\$289 <sup>99</sup>	EA	
PR3000	3.5" Standards only (pr)	\$1,799 <sup>99</sup>	PR	
1457053	Universal Winch	\$399 <sup>99</sup>	EA	



### FOLDING JUDGE'S STAND

- Free standing steel, portable judge's stand to use on any sleeved volleyball system
- Black powder coated finish with a grey vinyl padded platform
- Unit folds down enabling entire stand to be flat for storage
- Non-marking casters provide easy transport to any location

PR669100 \$749<sup>99</sup> EA ★ 



**JUDGE'S STAND SOLD SEPARATELY.**

### JUDGE'S STAND PADDING

- 1 3/8" thick polyethylene tube foam
- 15oz. vinyl covering, available in 14 colors
- Player protection from impact, easy to attach

PRJUDPAD Specify Color \$529<sup>99</sup> EA



FULLY CUSTOMIZABLE



### VOLLEYBALL NET SLEEVE

- Constructed of heavy 15oz. vinyl coated polyester fabric material
- Hook and loop closure attaches to any manufactures net quickly without affecting net play
- Fully customizable with school name and logo

PRNETSLVE0032 \$599<sup>99</sup> EA



### porter WALL STORAGE RACK

- Secures 2 volleyball poles in place
- Holds pole up to 3.5" diameter

PR825 \$249<sup>99</sup> EA



EQUIPMENT NOT INCLUDED

### VOLLEYBALL EQUIPMENT CART

- Constructed 1.5" 14-gauge powder coated steel tubing
- Storage basket is 8"D x 20"W x 5"L
- Transport and store up to 6 poles with other court accessories (balls, nets, pole pads, etc.)
- Includes 4 non-marring swivel casters
- 60"L x 32"W x 42"H

1197372 60 lbs. \$849<sup>99</sup> EA ★



**\$200 UPCHARGE POLE PAD GRAPHICS**  
**\$150 UPCHARGE CENTER STANDARD PAD GRAPHICS**  
**ON ALL PADS**

BSN SPORTS

### STANDARD PADS

- 15oz vinyl cover, 1 3/8" thick polyethylene filler
- Hook/Loop attachments
- Pads are cut and hinged to fold neatly around uprights and ratchets to provide a clean look

PRSTAPAD End Pole Pads-Specify Color \$749<sup>99</sup> PR ★  
 PRCTRPAD Center Pole Pad-Specify Color \$449<sup>99</sup> EA ★



## POWER STANDARDS

(FLOOR PLATE REQUIRED)

### 1. POWER PLAY GAME STANDARD

- 24" heavy wall steel base, with non-marring rubber floor protectors, non-marring wheels, and blue powder coated finish
- 2-3/8" heavy wall galvanized steel uprights with pre-set heights to play men's and women's volleyball, badminton, and tennis
- Includes: 2 safety padded guy wires, 2 floor plate anchors with hand bolts, 2 pulleys and a safety precision worm gear winch
- Designed for competitive play
- Recommended net - SNVBC32Y
- Requires floor anchoring.

**ST240PWR** 110 lbs. - Pair \$1,059<sup>99</sup> PR ★ 

### 2. POWER PLAY CENTER STANDARD

- Use with Power Play Game Standards (ST240PWR) for side by side court play
- Same Specifications as the ST240PWR
- Includes winch

**ST240PCS** 63 lbs. \$618<sup>99</sup> EA ★ 



### WORM GEAR STRAP WINCH

- Powder coated housing with stainless steel cover
- Low profile handle does not require removal
- Tension strap eliminates cable kinking
- Universal bolt pattern, designed to use with Power Play Game Standard

**ZWORMGEARX** \$159<sup>99</sup> EA ★



### PROTECTIVE BASE PAD

- Vinyl covered bonded foam
- Easy to install with hook-and-loop attachments
- Blue only

**1012385** 24" Diameter \$189<sup>99</sup> EA ★  
**1193572DS** 30" Diameter \$218<sup>99</sup> EA

## HEAVYWEIGHT STANDARDS

(RECOMMENDED FOR PE)

3.

### 24" MULTI-GAME STANDARD

- 24" heavy wall steel base, with non-marring rubber floor protectors, non-marring wheels, and blue powder coated finish
- 2-3/8" heavy wall galvanized steel uprights with pre-set heights to play men's and women's volleyball, badminton, and tennis
- Designed for recreational play
- Recommended net - SNVBC32Y
- Weighted base does not require floor anchoring

**ST240S/P** 360 lbs. - Pair \$1,179<sup>99</sup> PR ★ 

### 24" MULTI-GAME CENTER STANDARD

- Use with Multi-Game Standards (ST240S/P) for side-by-side court play
- Same specifications as ST240S/P

**ST240C/S** 180 lbs. \$699<sup>99</sup> EA ★ 

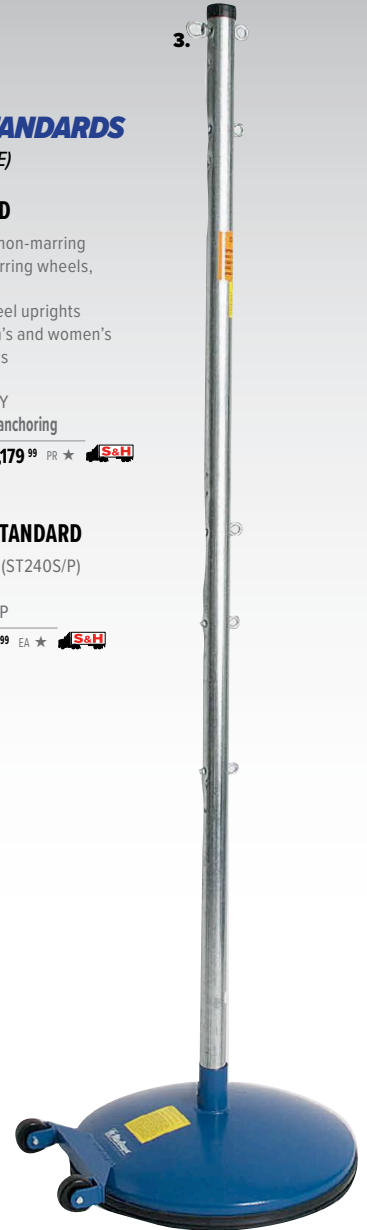

3.

### STANDARD POLE PAD

- Fits poles 3" O.D. or smaller
- 6'H with 2" thick vinyl covered foam and hook and loop fasteners
- Not intended for in-ground outdoor volleyball poles

**1012415** Royal Blue Only \$309<sup>99</sup> PR ★ 





NETS	USES	SIZE/BODY	HEADBAND	BOTTOM	CABLE	PRICE/CODE
	Ultimate Volleyball Net Telescopic Aluminum System AAI Systems	32' x 1m, 3.0mm braided knotted nylon	2" HD white polyester	1 1/4" HD white polyester side pockets; fiberglass dowels w/ 3 intergrated D-Rings white nylon webbing tension straps	34' Aramid fiber top Nylon rope bottom	\$329 <sup>99</sup> EA ★ <b>1235661</b>
	Master Volleyball Net Senoh & most Power VB systems	32' x 1m, 3.5mm braided knotless HTPP	18 oz coated vinyl top	18 oz vinyl w/ fiberglass dowels, 14 oz coated vinyl bottom	45' Aramid fiber top Nylon rope bottom	\$249 <sup>99</sup> EA ★ <b>1297058</b>
	Pro Power Volleyball Net VX2000 System PPS Steel System	32' x 1m, 3.5mm braided knotless nylon	14 oz laminate vinyl top/bottom	14 oz laminate w/ fiberglass dowels	34' PVC coated steel top cable w/ 3' 6" leader cable includes net tension straps	\$234 <sup>99</sup> EA ★ <b>1297065</b>
	Pro Power 2 Volleyball Net Systems w/ Double Ratchets	32' x 3', 2.5 mm polyethylene twisted knotted	2" HD 14 oz vinyl top/bottom	Steel dowels w/ synthetic leather cover 14 oz vinyl	40' L 1/8" thick coated steel top and bottom	\$110 <sup>99</sup> EA ★ <b>SNVBSP32Y</b>
	Sport Volleyball Net HS Physical Education ST240PWR	32' x 3', 2mm polyethylene twisted knotted	1.5" HD 14 oz vinyl top w/ 1.5" bottom	10 oz vinyl coated tape	40' L 1/8" thick coated steel top w/ vinyl coated tape bottom	\$74 <sup>99</sup> EA ★ <b>SNVBSC32Y</b>
	Recreational Volleyball Net Jr High Phys Ed ST240S/P ST240C/S	25', 27', 30', 32' x 3' Specify length 2mm polyethylene twisted knotted	1.5" HD 10 oz vinyl top	10 oz vinyl coated tape	1/4" thick rope top	\$48 <sup>99</sup> EA ★ <b>SNVBR</b>
	Multi-Color Economy Nets Recreational Play	32' x 3' 2 tone polyethylene 2mm twisted knotted	1.5" HD 10 oz vinyl top	10 oz vinyl coated tape	40' L 5/32" thick polyester rope top	\$34 <sup>99</sup> EA ★ <b>1048612</b>
	Economy Volleyball Net Elementary Physical Education	32' x 3', 1.75mm polyethylene twisted knotted	1.5" HD 10 oz vinyl top	10 oz vinyl coated tape	40' L 5/32" thick polyester rope top	\$45 <sup>99</sup> EA ★ <b>SNVBE02Y</b>

## Sport Write! COACHING TOOLS DRY-ERASE BOARDS

- Large format enables entire team to see play
- 2 writing surfaces
- Great pen clip with premium dry erase marker

**1383513** 12 1/2" H x 16 1/2" W - 2lbs. \$32<sup>99</sup> EA



## BSN SPORTS VOLLEYBALL SCOREBOOK

- Includes: 24 matches, 5 games per match and simplified instructions.
- NOW INCLUDES RALLY SCORING!!

**1111XXXX**

\$13<sup>99</sup> EA

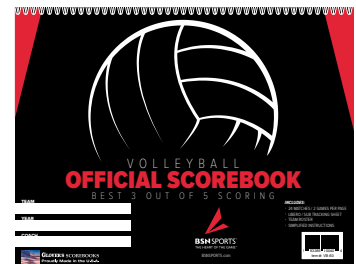





**VB NET STORAGE SYSTEM**

- Net storage system that prevents nets from getting tangled
- 3 storage options: 1 net, 2 nets or 3 nets

<b>1238822</b>	3 Nets	<b>\$415<sup>99</sup></b> EA
<b>1238815</b>	2 Nets	<b>\$381<sup>99</sup></b> EA
<b>1238808</b>	1 Net	<b>\$344<sup>99</sup></b> EA



**NET SETTER CHAIN**

- Hang from net to measure the correct height of the volleyball net
- 4 pre-set official net heights for Mens, Womens, Co-ed and Junior play

**1238778** **\$19<sup>99</sup>** EA

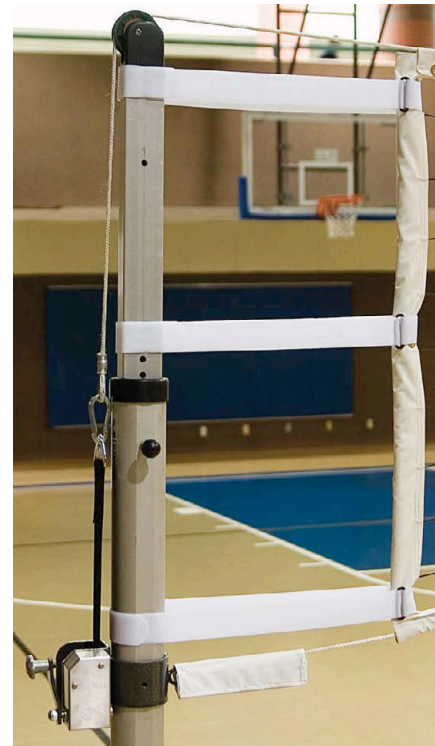

**VOLLEYBALL NET TENSION STRAPS**

- 2" velcro net straps that help secure volleyball net to standards
- Set includes 6 straps

**1203486** **\$67<sup>99</sup>** SET OF 6 ★



**LINESMAN FLAGS**

- Set of 4 linesman flags with case
- Deluxe aluminum handles with soft grips
- Flag Size: 12" x 12"

**1376640** **\$34<sup>99</sup>** SET



**VOLLEYBALL ANTENNA**

- White antenna holder is 1" wide complete with velcro strips that secure system to net.
- The antenna slips easily into a pocket for correct positioning on the net.

**VBANT** **\$69<sup>99</sup>** PR ★



**FLOOR TAPE APPLICATOR**

- Sturdy steel applicator
- Ideal for laying 1" or 2" single sided tape
- Use for straight or curved lines

**TAPEMAC** **\$69<sup>99</sup>** EA ★



**FLOOR MARKING TAPE**

- Use on any smooth floor surface
- Color Options: **Black, Blue, Green, Gold, Orange, Purple, Red, White.**

<b>FTAP16</b>	1" x 60 Yd.	<b>\$10<sup>99</sup></b> EA ★
<b>FTAP26</b>	2" x 60 Yd.	<b>\$12<sup>99</sup></b> EA ★

**FLOORMARX™ SET**

- Fast drying ink (2min) and cleaning wipes (30 sec)
- One Floor Marker writes for over 250 yards
- Set includes 2 Floor markers, 1 green and 1 blue, and 1 canister of cleaning foot wipes
- Intended for sealed gymnasiums and dance floors, and other non-porous surfaces
- BEFORE FULL APPLICATION, always test on multiple, small, inconspicuous areas of the floor



**1454864** **\$45<sup>99</sup>** SET



**NEW!**

**H2O PERFORMANCE PACK**

- Performance Pack includes 5 markers: red, orange, green, blue, and purple
- One canister of foot wipes
- One bag of R&R foot towels (20 towels)

**1461860** **\$84<sup>99</sup>** PACK

## porter®

### POWR-SAND VOLLEYBALL PACKAGE

- Competition Plus Package Includes: Powr-Sand Standards (pr), Upright Protective Pads (pr), Outdoor Competition Volleyball net, Powr-Select Net Antennas (pr), Fair Height Net Chain, Powr-Sand Judge's Stand, Powr-Sand Judge's Stand Padding, and Sand Rake
- Competition Package includes: Powr-Sand Standards (pr), Upright Protective Pads (pr), Outdoor Competition Volleyball net, Powr-Select Net Antennas (pr), and Fair Height Net Chain
- Judge's stand is only included in the Competition PLUS Package

PR30910	Competition Plus Package	\$5,999 <sup>99</sup> EA
PR30911	Competition Package	\$5,299 <sup>99</sup> EA



PVC WITH NO CAP



GALVANIZED STEEL WITH WRENCH CAP



ROPE CABLE NET SYSTEM UTILIZES GALVANIZED STEEL ROPE CLEATS FOR EASY NET ATTACHMENT.



STEEL CABLE NET SYSTEM INCLUDES HEAVY DUTY STEEL RATCHET WITH REMOVABLE HANDLE.



### SPECTRUM 2000 VOLLEYBALL SYSTEM

- Quick set up and completely portable
- Aluminum standards have push button locks for easy height adjustment
- Set includes: 1 3/4" telescopic 2-piece aluminum poles, 3' x 32' sleeve net, 1/4" pull-down guyline system, 10" steel stakes, pre-measured boundary w/corner anchors, winder and storage bag

15 Year Limited Warranty

60790XXX

\$429<sup>99</sup> SET

### OUTDOOR VOLLEYBALL PACKAGES

- 10'H x 2 3/8" O.D. galvanized steel pole inserts 2' into ground sleeves or can be permanently installed in concrete
- Pre-Drilled for volleyball, badminton and tennis
- All weather treated net secures through eye bolts

<b>VBPK1</b>	Steel Top Cable Net - PVC Ground Sleeves/No Cap	\$659 <sup>99</sup> SET ★ <b>S&amp;H</b>
<b>VBPK2</b>	Steel Top Cable Net/Steel Ground Sleeves/With Cap	\$829 <sup>99</sup> SET ★ <b>S&amp;H</b>
<b>VBPK3</b>	Rope Top Cable Net/PVC Ground Sleeves/No Cap	\$629 <sup>99</sup> SET ★ <b>S&amp;H</b>
<b>VBPK4</b>	Rope Top Cable Net/Steel Ground Sleeves/With Cap	\$819 <sup>99</sup> SET ★ <b>S&amp;H</b>

### MONGOOSE WIRELESS VOLLEYBALL SYSTEM

- 2 adjustable high-strength anodized black aluminum posts
- 2 steel in-ground plates
- 2 sand wedge adapters
- 2 blue protective pole pads
- Regulation size net, court boundary line marker, blue nylon carrying bag, and instructions

Lifetime Warranty

1138214 Wireless System \$649<sup>99</sup> SET



MARK YOUR COURT WHEREVER YOU PLAY!

### VOLLEYBALL BOUNDARY MARKERS

- 1/4" heavy-duty polypropylene rope with mid-point net markers, splice protector corner sleeves, nickel-plated corner rings
- Official 30' x 60' court size
- Includes storage winder

90355YLX

Yellow Only

\$62<sup>99</sup> EA ★

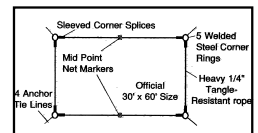



## LIGHTWEIGHT WRESTLING MATS

- Constructed of our tough 24oz. non-slip vinyl and premium grade lightweight foam
- Quick and easy setup, breakdown, and storage
- Fast and easy to move, comes in 1 5/8" or 2" thickness
- Antimicrobial-treated vinyl surface
- Exceeds ASTM F1081/F355 impact protection standards
- 5-year limited warranty, mats are made to order, ships in 9-12 weeks (depending on product availability)
- Mat colors: Royal, Navy, Red, Black, Light Grey, Dk Green, Maroon, Gold, Purple, White, Orange

### 5 Year Limited Warranty

1393094	36' x 36' x 1 5/8" (6-6' x 36' sections)	\$6,999 <sup>99</sup> EA
1393095	42' x 38' x 1 5/8" (7-6' x 38' sections)	\$8,499 <sup>99</sup> EA
1393096	42' x 40' x 1 5/8" (7-6' x 40' sections)	\$8,899 <sup>99</sup> EA
1393097	42' x 42' x 1 5/8" (7-6' x 42' sections)	\$9,399 <sup>99</sup> EA
1393101	36' x 36' x 2" (6-6' x 36' sections)	\$7,999 <sup>99</sup> EA
1393102	42' x 38' x 2" (7-6' x 38' sections)	\$9,799 <sup>99</sup> EA
1393103	42' x 40' x 2" (7-6' x 40' sections)	\$10,299 <sup>99</sup> EA
1393104	42' x 42' x 2" (7-6' x 42' sections)	\$10,799 <sup>99</sup> EA

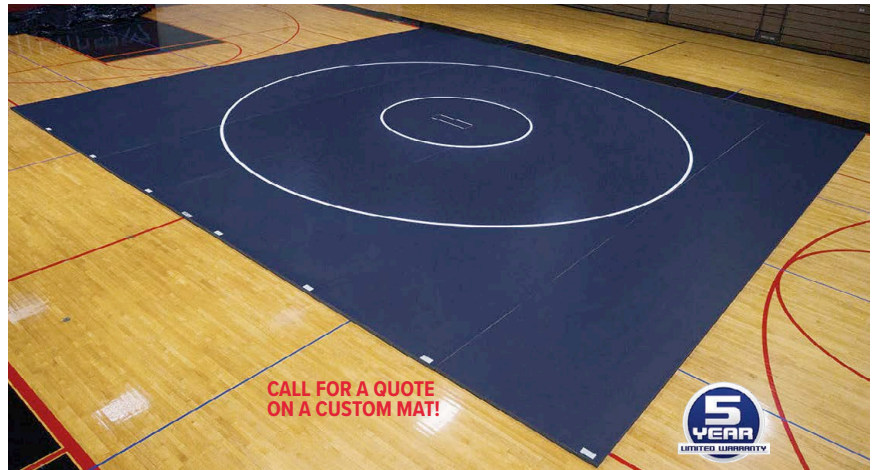

## LIGHTWEIGHT WRESTLING MAT-SINGLE ROLLS

- Constructed of our tough 24oz. non-slip vinyl and premium grade lightweight foam
- Antimicrobial-treated vinyl surface
- Exceeds ASTM F1081/F355 impact protection standards
- Incredibly fast and easy to set up, breakdown, store and move
- 5-year limited warranty
- Choose from 9 mat colors: Royal, Navy, Red, Black, Grey, Dk Green, Maroon, Gold, Purple

### 5 Year Limited Warranty

1393245	Single Roll-6' x 36' x 1 5/8"	\$1,199 <sup>99</sup> EA
1393246	Single Roll-6' x 38' x 1 5/8"	\$1,249 <sup>99</sup> EA
1393247	Single Roll-6' x 40' x 1 5/8"	\$1,299 <sup>99</sup> EA
1393248	Single Roll-6' x 42' x 1 5/8"	\$1,369 <sup>99</sup> EA



## HIGH SCHOOL/COLLEGIATE WRESTLING MATS

Wrestling mats are manufactured to meet NCAA specifications. Constructed with lightweight, crack-proof, anti-bacterial/anti-fungal materials, these mats feature durable vinyl PVC outer that is bonded to the foam core. Standard price includes: Single color mat w/ 10' diameter center circle and outer boundary circle, reverse side has 9 practice circles

### ADDITIONAL FEATURES:

- Dense, 1" or 1-1/4" thick shock absorbing mat
- Tough poly-vinyl #457 coating
- No cross-seams in official wrestling area, wrestling mats are made to order, ships in 9-12 weeks (depending on product availability)
- Ensolite AAC foam core as used for the NCAA Championships
- Multi-colors, customized insignias & lettering available at additional charge
- 26 color choices: White, Light Grey, Grey, Metallic Silver, Black, Pale Yellow, Light Gold, Metallic Gold, Old Gold, Kelly Green, Medium Green, Dark Green, Red, Orange, Burnt Orange, Light Maroon, Dark Maroon, Chocolate Brown, Turquoise, Sea Green, Columbia Blue, Bright Blue, Royal Blue, Penn State Blue, Navy Blue, Purple
- Mats may be divided into multiple sections for easy handling
- NCAA rules require a mat size of 42' x 42' with a minimum wrestling circle of 32'.
- High School regulation size is 38' x 38' with a minimum 28' wrestling circle.

6426XXXX	1" Thick Material	\$12 <sup>99</sup> SQ.FT	
6428XXXX	1-1/4" Thick Material	\$13 <sup>99</sup> SQ.FT	

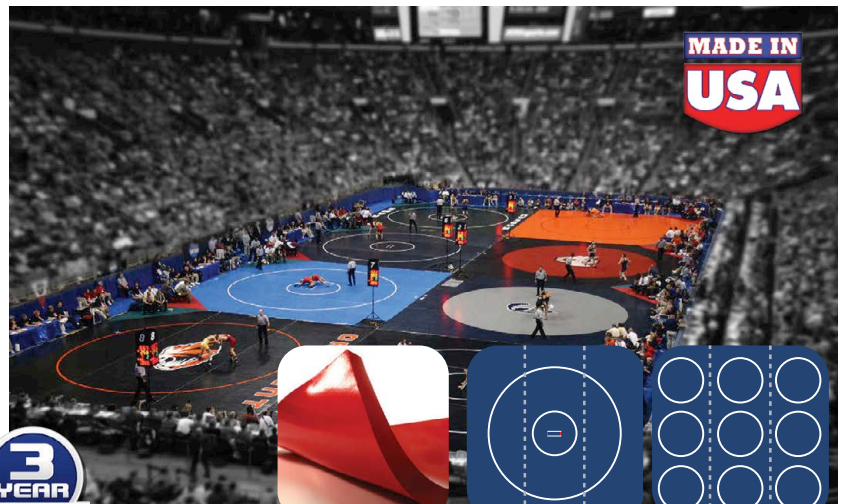

STANDARD LAYOUT

PRACTICE CIRCLES



### MATT-KLEEN™ ALL PURPOSE DISINFECTANT CLEANER

- Helps stop the spread of skin diseases and infections
- Ideal for wrestling and gymnastic mats, training tables and shower floors
- Highly concentrated; 2 oz. makes one full gallon



1092479      Gallon      \$99.99 EA



### WHIZZER®

- Multipurpose concentrate kills HIV-1 (AIDS virus), MRSA, Hepatitis B & C, and other viruses. Kills strep, staph and fungus germs on contact.
- Cleaner, fungicide, mildewstat, virucide and deodorizer - all in one. Comes complete with 2 FREE Pint spray bottles.
- Economical. One ounce of concentrate mixed with water makes a gallon of full-strength disinfectant. 128 dilutions per gallon.
- Fast. Apply directly to mats, floors, walls, training tables, locker rooms, or personal items. Just wipe dry.

#### 30 Day Limited Warranty

MU230201      1 Gallon + 2 FREE Pint Spray Bottles      \$94.99 CASE



### SUPER BANDS

- Seamless latex rubber prevents breakage
- Band stretches to create constant tension that targets muscles throughout entire movement
- Color-coded to indicate resistance levels



1455154	Super Light	\$15.99 EA
1455155	Ultra Light	\$21.99 EA
1455156	Light	\$26.99 EA
1455157	Medium	\$32.99 EA
1455158	Heavy	\$41.99 EA
1455159	Ultra Heavy	\$67.99 EA
1457082	Super Heavy	\$89.99 EA

### ZEHN-X WIPES

- These oversized wipes (8' x 6") are made with natural ingredients for safe and effective cleansing
- Made with rayon mesh for strength, aloe vera and tree oil for added protection and antibacterial properties
- Includes Benzalkonium Chloride(BZK) which is completely alcohol free
- BZK provides the antimicrobial action

1459126	180-Count Tub	\$17.99 EA
1459127	1200-Count Pkg	\$59.99 EA



### LOCK-JAW COLLAR

- Solid nylon injection molded frame and injection molded pads
- Single-action cam lock securely clamps the collar to the bar
- For use with Olympic bars

1379947      Black Only      \$49.99 PR



### LOCK-JAW PRO COLLAR

- The larger lever and SPRING LOADED SNAP LATCH ensures easy installation and removal of the collar
- The exceptional clamping force keeps the weights secured
- The PRO is for serious lifters, high-impact workouts, and anytime bumper plates are used on a bar

1395572      Black Only      \$51.99 PR



### CHROME SPRING COLLAR

- For use with Olympic bars

1015911      \$27.99 PR ★



### VERTICAL OLYMPIC BAR HOLDER

- Holds 8 Olympic style bars securely in a minimal amount of space
- Horns have nylon sleeves to protect bars
- 16" diameter x 3/4" solid steel base with black powder coated finish

20028055      42 lbs.      \$209.99 EA ★



### OLYMPIC-STYLE TRICEP BOMBER

- Constructed of 1" chrome stock
- For use with Olympic-style plates
- Includes wrenchless collars
- Weight plates sold separately

CHTRICOL      \$199.99 EA ★



### OLYMPIC TRAP/HIP BAR

- Dual high/low handle design
- For use with Olympic-style plates
- 57"L x 25"W x 6"H - 60lbs.

1455250      \$399.99 EA ★



### LAND MINE TRAINER

- Made of heavy-duty 11 gauge black powder coated steel
- Perform dynamic movements and exercises simply by inserting any Olympic-size bar (not included) into the 10" pivoting sleeve
- 5" lower tube inserts into any standard Olympic plate to create an anchor/base

1377173      \$95.99 EA



### CAMBERED SQUAT BAR

- This bar allows squats to be done in a more vertical posture, producing more intense quadricep involvement
- Cambered end design relieves lower back stress normally associated with a traditional back squat
- All steel design with padded shoulder harness
- 2000 lb. maximum capacity

PMWT129      5" H x 16" W x 92.5" L - 66 lbs      \$475.99 EA



## OLYMPIC WEIGHT SETS

- All sets include:
- 28.5mm (1.12") diameter grip x 2.2m (86.6") long Olympic bar made to AAU/IWF specifications with 50mm (1.96") diameter sleeves
  - Bronze bushings for smooth sleeve rotation
  - Olympic grip plates with grey hammertone, acrylic finish
  - One pair of chrome spring collars

### Economy 300 Lb. Weight Set

- Includes 700 lb. capacity chrome bar and spring collars
- 14 Olympic grip plates - 2/45's, 2/35's, 2/25's, 2/10's, 4/5's, 2/2.5's

**1035636** \$824<sup>99</sup> SET ★

### 300 LB. Standard Weight Set

- Includes 1000 lb. capacity black zinc bar with chrome sleeves and spring collars
- 14 Olympic grip plates - 2/45's, 2/35's, 2/25's, 2/10's, 4/5's, 2/2.5's

**WSETS310** \$949<sup>99</sup> SET ★

### 300 Lb. Deluxe Weight Set

- Includes 1500 lb. capacity black oxide bar and spring collars
- 14 Olympic grip plates - 2/45's, 2/35's, 2/25's, 2/10's, 4/5's, 2/2.5's

**CHCOS310** \$1,099<sup>99</sup> SET ★

### 400 Lb. Olympic Set

- Includes 1500 lb. capacity black oxide bar and spring collars
- 18 Olympic grip plates - 4/45's, 2/35's, 2/25's, 2/10's, 6/5's, 2/2.5's

**CHCOS400** \$1,299<sup>99</sup> SET ★

### 500 Lb. Olympic Weight Set

- Includes 1500 lb. capacity black oxide bar and spring collars
- 22 Olympic grip plates - 6/45's, 2/35's, 2/25's, 2/10's, 8/5's, 2/2.5's

**CHCOS500** \$1,399<sup>99</sup> SET ★



## RUBBER COATED OLYMPIC GRIP PLATE

- Will not crack, chip, flake, peel, rust or tear like painted cast iron plates
- Prevents damage to floors, upholstery and will not dent or scratch equipment
- Reduces weight room noise
- Set includes: 1000 lb. capacity Olympic bar, 2 each 45 lb, 35 lb, 25 lb, 10 lb, 2.5 lb, 4 each 5 lb rubber coated grip plates and a pair of 2" Muscle Clamps (Black)

<b>1272550</b>	2.5 lb.	\$14 <sup>99</sup> EA ★	<b>1272581</b>	25 lb.	\$94 <sup>99</sup> EA ★
<b>1272567</b>	5 lb.	\$23 <sup>99</sup> EA ★	<b>1272598</b>	35 lb.	\$121 <sup>99</sup> EA ★
<b>1272574</b>	10 lb.	\$41 <sup>99</sup> EA ★	<b>1272604</b>	45 lb.	\$159 <sup>99</sup> EA ★

### 300 lb. set with 1000 lb. Capacity Bar

**1256574** \$1,249<sup>99</sup> SET ★



## OLYMPIC GRIP PLATES

- All plates have a durable, grey hammertone, acrylic finish

<b>1272475</b>	2.5 lb.	\$9 <sup>99</sup> EA ★	<b>1272512</b>	35 lb.	\$84 <sup>99</sup> EA ★
<b>1272482</b>	5 lb.	\$15 <sup>99</sup> EA ★	<b>1272529</b>	45 lb.	\$114 <sup>99</sup> EA ★
<b>1272499</b>	10 lb.	\$26 <sup>99</sup> EA ★	<b>1272536</b>	100 lb.	\$237 <sup>99</sup> EA ★
<b>1272505</b>	25 lb.	\$63 <sup>99</sup> EA ★			



## OLYMPIC COMPETITION BUMPER BLACK

- Will not crack, chip, flake, peel, rust or tear like painted cast iron plates.
- Prevents damage to floors, upholstery and will not dent or scratch equipment.
- 32.8 feet factory drop test passed 20,000 drops.
- 450mm diameter steel ring inserts.
- Zinc coated steel disc insert.

<b>1459633</b>	25lb	\$179 <sup>99</sup> EA ★
<b>1459634</b>	35lb	\$209 <sup>99</sup> EA ★
<b>1459635</b>	45lb	\$249 <sup>99</sup> EA ★
<b>1459636</b>	55lb	\$269 <sup>99</sup> EA ★



## OLYMPIC URE OLYMPIC BUMPER PLATE BL 10L

- Will not crack, chip, flake, peel, rust or tear like painted cast iron plates  
Prevents damage to floors, upholstery and will not dent or scratch equipment. Reduces weight room noise  
32.8 feet factory drop test passed 20,000 drops  
450mm diameter steel ring inserts

<b>1459637</b>	10lb	\$135 <sup>99</sup> EA ★
<b>1459638</b>	25lb	\$199 <sup>99</sup> EA ★
<b>1459639</b>	35lb	\$259 <sup>99</sup> EA ★
<b>1459640</b>	45lb	\$299 <sup>99</sup> EA ★
<b>1459641</b>	55lb	\$349 <sup>99</sup> EA ★



## OLYMPIC RUBBER PLATE BLACK

- Will not crack, chip, flake, peel, rust or tear like painted cast iron plates  
Prevents damage to floors, upholstery and will not dent or scratch equipment. Reduces weight room noise  
32.8 feet factory drop test passed 20,000 drops  
450mm diameter steel ring inserts

<b>1459642</b>	10lb	\$39 <sup>99</sup> EA ★
<b>1459643</b>	15lb	\$55 <sup>99</sup> EA ★
<b>1459644</b>	25lb	\$89 <sup>99</sup> EA ★
<b>1459645</b>	35lb	\$109 <sup>99</sup> EA ★
<b>1459646</b>	45lb	\$139 <sup>99</sup> EA ★
<b>1459647</b>	55lb	\$169 <sup>99</sup> EA ★



**OLYMPIC STYLE BARS**

- 1453179 Elite level bar with hard chrome 1 pc sleeves, 3 diamond knurls with dual grip markings, & over 200,000 PSI strength
- All bars are made of high-tensile chrome-molybdenum steel
- All bars have bronze bushings for smooth sleeve rotation and no end screws
- 1101247 features special center knurling, made especially for power lifters
- All bars carry a 10 year limited warranty

1. <b>1453179</b>	86" Black Chrome - 1500 lb. Capacity	\$499 <sup>99</sup> EA ★ <b>S&amp;H</b>
2. <b>1101247</b>	86" Zinc Plated - 1500 lb. Capacity	\$424 <sup>99</sup> EA ★ <b>S&amp;H</b>
3. <b>1101248</b>	86" Black Oxide - 1500 lb. Capacity	\$424 <sup>99</sup> EA ★ <b>S&amp;H</b>
4. <b>1101249</b>	86" Black Zinc with Chrome Sleeves - 1000 lb. Capacity	\$339 <sup>99</sup> EA ★ <b>S&amp;H</b>
5. <b>CHCOB760</b>	60" Chrome Plated - 700 lb. Capacity	\$275 <sup>99</sup> EA ★ <b>S&amp;H</b>
6. <b>1101250</b>	72" Aluminum Technique Bar - 200 lb. Capacity	\$259 <sup>99</sup> EA ★ <b>S&amp;H</b>
7. <b>CHCOCBXX</b>	Olympic 47" EZ Curl Bar	\$169 <sup>99</sup> EA ★ <b>S&amp;H</b>
8. <b>CHSNPXXX</b>	Bar Wrap Pad	\$21 <sup>99</sup> EA ★

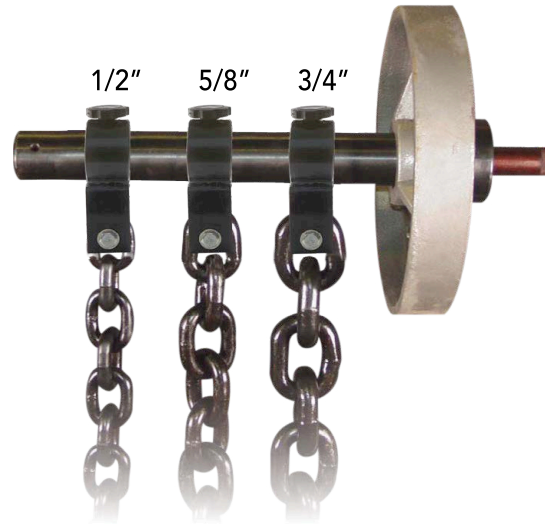

**WEIGHT LIFTING CHAINS**

- Helps zero-out momentum near lockout for a more effective lift.
- No more coasting as you reach the top of your lifts! Each link provides consistent and accumulated resistance as it's lifted off the floor
- Sold in pairs, each 60"L, with black powder coated bar collars

**30 Day Limited Warranty**

1460276	1/2" 25 lbs	\$179 <sup>99</sup> PR
1460277	5/8" 45 lbs	\$215 <sup>99</sup> PR
1460278	3/4" 55 lbs	\$269 <sup>99</sup> PR



**POWER ROPE ANCHOR STATION**

- Use indoors or outside
- Accommodates up to 12 users at one time
- Solid rubber bottom for floor protection
- Add up to 4 - 45 lb. Olympic weight plates for maximum stability
- All welded, all silver powder coated steel construction
- 6.5"H x 23.5"W x 23.5"D - 32 lbs.
- Power ropes and weight plates sold separately

**1375090** \$249<sup>99</sup> EA ★



**FITNESS POWER ROPES**

- Various lengths and diameters to enhance the overall work-out experience
- Great for grip strength, stamina and overall conditioning
- Ideal for upper body and core exercises

<b>1369620</b>	1.5"Ø - 30'L	\$179 <sup>99</sup> EA ★
<b>1369621</b>	1.5"Ø - 40'L	\$226 <sup>99</sup> EA ★
<b>1369622</b>	1.5"Ø - 50'L	\$261 <sup>99</sup> EA ★
<b>1369624</b>	2"Ø - 30'L	\$273 <sup>99</sup> EA ★
<b>1369625</b>	2"Ø - 40'L	\$324 <sup>99</sup> EA ★
<b>1369626</b>	2"Ø - 50'L	\$377 <sup>99</sup> EA ★





### SOLID HEX DUMBBELLS

- Solid cast iron with durable, grey hammertone, acrylic finish
- Straight handles with deep set knurling for functional performance
- Now sold as each, not pairs

<b>1152051</b>	3 lb.	\$10 <sup>99</sup> EA ★	<b>1152063</b>	60 lb.	\$135 <sup>99</sup> EA ★
<b>1152052</b>	5 lb.	\$17 <sup>99</sup> EA ★	<b>1152064</b>	65 lb.	\$145 <sup>99</sup> EA ★
<b>1152053</b>	10 lb.	\$24 <sup>99</sup> EA ★	<b>1152065</b>	70 lb.	\$159 <sup>99</sup> EA ★
<b>1152054</b>	15 lb.	\$37 <sup>99</sup> EA ★	<b>1152066</b>	75 lb.	\$169 <sup>99</sup> EA ★
<b>1152055</b>	20 lb.	\$49 <sup>99</sup> EA ★	<b>1152067</b>	80 lb.	\$179 <sup>99</sup> EA ★
<b>1152056</b>	25 lb.	\$59 <sup>99</sup> EA ★	<b>1152068</b>	85 lb.	\$189 <sup>99</sup> EA ★
<b>1152057</b>	30 lb.	\$69 <sup>99</sup> EA ★	<b>1152069</b>	90 lb.	\$199 <sup>99</sup> EA ★
<b>1152058</b>	35 lb.	\$79 <sup>99</sup> EA ★	<b>1152070</b>	95 lb.	\$219 <sup>99</sup> EA ★
<b>1152059</b>	40 lb.	\$99 <sup>99</sup> EA ★	<b>1152071</b>	100 lb.	\$225 <sup>99</sup> EA ★
<b>1152060</b>	45 lb.	\$105 <sup>99</sup> EA ★	<b>1390919</b>	5-50 lb. Set	\$1,199 <sup>99</sup> SET ★
<b>1152061</b>	50 lb.	\$115 <sup>99</sup> EA ★	<b>1390921</b>	55-100 lb. Set	\$2,999 <sup>99</sup> SET ★
<b>1152062</b>	55 lb.	\$129 <sup>99</sup> EA ★			



### RUBBER ENCASED SOLID HEX DUMBBELLS

- Permanently attached cast iron heads are encased in maintenance free virgin rubber
- Ergonomically designed solid steel handle for comfort and safety
- Handles are knurled and chrome plated; will not peel or chip

<b>20028384EA</b>	3 lb.	\$19 <sup>99</sup> EA ★	<b>20028387EA</b>	60 lb.	\$179 <sup>99</sup> EA ★
<b>20028375EA</b>	5 lb.	\$26 <sup>99</sup> EA ★	<b>20028388EA</b>	65 lb.	\$189 <sup>99</sup> EA ★
<b>20028376EA</b>	10 lb.	\$45 <sup>99</sup> EA ★	<b>20028389EA</b>	70 lb.	\$215 <sup>99</sup> EA ★
<b>20028377EA</b>	15 lb.	\$55 <sup>99</sup> EA ★	<b>20028390EA</b>	75 lb.	\$219 <sup>99</sup> EA ★
<b>20028378EA</b>	20 lb.	\$69 <sup>99</sup> EA ★	<b>20028391EA</b>	80 lb.	\$235 <sup>99</sup> EA ★
<b>20028379EA</b>	25 lb.	\$79 <sup>99</sup> EA ★	<b>20028392EA</b>	85 lb.	\$249 <sup>99</sup> EA ★
<b>20028380EA</b>	30 lb.	\$89 <sup>99</sup> EA ★	<b>20028393EA</b>	90 lb.	\$269 <sup>99</sup> EA ★
<b>20028381EA</b>	35 lb.	\$109 <sup>99</sup> EA ★	<b>20028394EA</b>	95 lb.	\$279 <sup>99</sup> EA ★
<b>20028382EA</b>	40 lb.	\$125 <sup>99</sup> EA ★	<b>20028395EA</b>	100 lb.	\$295 <sup>99</sup> EA ★
<b>20028383EA</b>	45 lb.	\$129 <sup>99</sup> EA ★	<b>1390920</b>	5-50 lb. Set	\$1,499 <sup>99</sup> SET ★
<b>20028385EA</b>	50 lb.	\$149 <sup>99</sup> EA ★	<b>1390922</b>	55-100 lb. Set	\$3,499 <sup>99</sup> SET ★
<b>20028386EA</b>	55 lb.	\$169 <sup>99</sup> EA ★			



### ADJUSTABLE DUMBBELL RACK

- Cradle width is adjustable during assembly to accommodate an inside handle length between 4 1/2" and 5 3/8"
- Cradles are black UHMW polyethylene
- 2" x 3" 11-gauge steel frame construction with silver powder coated finish
- Dumbbells not included

**811100** 12 Pair Rack - 36"H x 24"D x 70"L **\$749<sup>99</sup> EA ★**

### PRO COMMERCIAL SETS

- Urethane Coated Steel Plates
- Zytel Pin (Pro 50/90/125)
- Stainless Steel Hardware
- Stand Included (Pro 50, 90, 125/175)
- Knurled Steel Grip (Pro 50 & 90)
- TPR Contoured Grip (Pro 125/175)
- 1 Year Commercial Limited Warranty
- Footprint on Stand : 21.5" x 25"

<b>1461802</b>	50 lbs	\$1,329 <sup>99</sup> PR
<b>1461803</b>	90 lbs	\$2,155 <sup>99</sup> PR
<b>1461804</b>	125 lbs	\$2,603 <sup>99</sup> PR



### UPRIGHT DUMBBELL STORAGE RACKS

- Space saving design with maximum storage capacity
- Accommodates most styles of dumbbells
- 42" High with 9" X 19" base
- Dumbbells not included

<b>1137563</b>	2-Sided - Holds 8 Pair	\$275 <sup>99</sup> EA ★
<b>1137574</b>	4-Sided - Holds 13 Pair	\$415 <sup>99</sup> EA ★





# CHAMPION BARBELL™



### MULTI-BENCH

- Adjusts to decline, flat or incline positions
- Constructed of 2" x 3" heavy wall steel tubing
- Pads constructed of 2.5" high density foam with Black marine grade vinyl
- Padded leg support for added stability
- 20.5"H x 26"W x 62.5"D - 68 lbs.

601102

\$429<sup>99</sup> EA ★



### WHEELED ADJUSTABLE WEIGHT BENCH

- 7 adjustments from 10 degrees decline to 80 degrees incline
- 5 seat height adjustments
- Constructed of 2" x 3" heavy wall steel tubing
- Pads are 2.5" high density foam with Black marine grade vinyl
- 20"H x 23"W x 54"D - 100 lbs.

815102

813702

No Spotter's Platform  
With Spotter's Platform

\$674<sup>99</sup> EA ★

\$699<sup>99</sup> EA ★



### ADJUSTABLE CURL BENCH

- Constructed of 2" x 3" heavy wall steel tubing
- Fully adjustable arm pad to accommodate different sized users
- Pads are 2.5" high density foam covered in Black marine grade vinyl
- 32.5"H x 28"W x 41"D - 63 lbs.

600200

\$365<sup>99</sup> EA ★

### FLAT BENCH

- Great for dumbbell flies, rows, pullovers and tricep extensions
- Constructed of 2" x 3" heavy wall steel tubing
- Pads are 2.5" high density foam with Black marine grade vinyl
- Includes wheels for mobility
- 19.5"H x 21"W x 51.5"D - 50 lbs.

600902

\$299<sup>99</sup> EA ★



### ADJUSTABLE INCLINE BENCH WITH SPOTTERS PLATFORM

- Constructed of 2" square heavy wall steel tubing
- Ideal for developing deltoids and upper pectorals
- Pad is 10"W x 42"L and adjusts from 36° to 56° and is constructed of 2.5" high density foam with 40 oz. Black marine grade vinyl
- Includes spotter's platform
- 45"H x 48"W x 48"D - 140 lbs.

812702

\$799<sup>99</sup> EA ★



### FIELD HOUSE COMPETITION BENCH

- Constructed of 3" x 3" and 2" x 3" heavy wall steel tubing for maximum stability with heavy weights
- Pad is constructed of 2.5" high-density foam with 40 oz. Black marine grade vinyl
- Equipped with lower safety bar rests
- 44"H x 49"W x 52"D - 120 lbs.

814402

\$599<sup>99</sup> EA ★



### STANDARD BENCH PRESS

- Constructed of 1.5" square heavy wall steel tubing
- Pad is constructed of 2.5" high density foam covered in 40 oz. Black marine grade vinyl
- Equipped with lower safety bar rests
- 44"H x 45"W x 48"D - 72 lbs.

814002

\$449<sup>99</sup> EA ★



## POWER RACKS

- Constructed of 3" x 3" and 2" x 3" heavy wall silver powder coated steel tubing
- 10 weight storage horns with protective wear sleeves and rubber bump stops
- Easily adjustable J-Hook bar catches and safeties with UHMW polyethylene bar guards
- Includes a multi-grip pull up bar and multiple resistance band attachments
- Double Half Rack includes 2 bar storage holders
- Full Power Rack: 96"H x 48"W x 80"D - 460 lbs.
- Double Half Rack: 96"H x 48"W x 91"D - 606 lbs.
- Half Rack: 96"H x 48"W x 57"D - 368 lbs.
- Power lift platform is 8' x 8' with a steel frame and 3/4" rubber top
- A 1 1/2" plywood sub floor consisting of 4 sheets of 3/4" plywood provides a solid non-skid, noise absorbing surface (Plywood is not included with the platform.)
- Accessories sold separately.



J-Hook Bar Catch



Resistance Band Attachments



### FULL POWER RACK

813900

\$2,099<sup>99</sup> EA ★



J-Hook Bar Catch



Resistance Band Attachments



Bar Storage Sleeve

### DOUBLE SIDED HALF RACK

817000

\$2,999<sup>99</sup> EA ★



### HALF POWER RACK

813800

816900

817100

Half Rack and Platform

Half Rack Only - Floor Mount

Power Lift Platform Only

\$2,299<sup>99</sup> EA ★

\$1,799<sup>99</sup> EA ★

\$849<sup>99</sup> EA ★

## 4-WAY MULTI-FUNCTION GYM

- Four stations for every aspect of your workout
- Used for chest/shoulder press, leg extension, lat pull down and low row
- 83.5"H x 48"W x 75"L - 537 lbs.

**156002** \$2,399<sup>99</sup> EA ★ **S&H**



## POWER RACK

- Constructed of 2" x 3" heavy wall steel tubing
- Adjustable 1" solid rod safety bars
- Includes pull up bar
- 24" Lifting area between uprights
- 92"H x 48"W x 42"D - 245 lbs.

**810900** \$799<sup>99</sup> EA ★ **S&H**

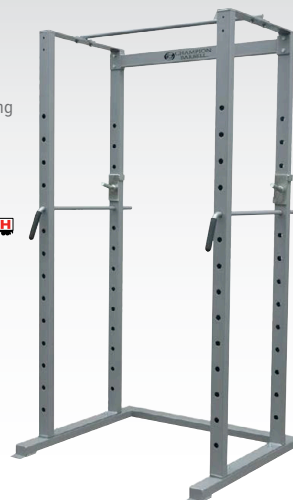

## CABLE ATTACHMENTS

<b>1. CHLBPROX</b>	30" Pro-Style Lat Bar	\$59 <sup>99</sup> EA ★
<b>2. CHLB481X</b>	48" x 1" Lat Bar	\$75 <sup>99</sup> EA ★
<b>3. CHLBHNDL</b>	Single Chrome Handle	\$21 <sup>99</sup> EA ★
<b>4. CHLB20RT</b>	20" Rotating Straight Bar	\$39 <sup>99</sup> EA ★
<b>5. CHLBTRXX</b>	Nylon Tricep Rope	\$40 <sup>99</sup> EA ★
<b>6. CHLBVPRS</b>	V Shaped Press Down Bar	\$31 <sup>99</sup> EA ★
<b>7. CHLBMLTI</b>	Revolving Multi-Exercise Bar	\$50 <sup>99</sup> EA ★
<b>8. 1101263</b>	Nylon Ankle Strap	\$24 <sup>99</sup> EA ★
<b>1382829</b>	Deluxe Cable Attachment Package (1 each of all of the above)	\$319 <sup>99</sup> SET ★



## PLATE-LOADED LAT PULLDOWN/LOW ROW COMBO

- Constructed of 2" square heavy wall steel tubing
- Includes rowing attachment, 20" bar and 48" lat bar
- Equipped with height adjustable seat and knee rollers
- Pad is constructed of 2.5" high-density foam with 40 oz. Black marine grade vinyl
- 86"H x 30"W x 65"L - 185 lbs.

**814902** \$1,099<sup>99</sup> EA ★ **S&H**

## SMITH MACHINE

- Constructed of 2" X 3" heavy wall steel tubing
- 7'L - 700 lb capacity bar rotates on precision roller bearings
- Bar uses precision linear bearings to glide friction free on 1" solid case hardened rods
- Solid steel peg and hook safety catch system with separate adjustable safety stops spaced every 7 inches
- Includes 8 weight storage horns
- 84"H x 71.5"W x 68"D - 310 lbs.

**815802** \$2,599<sup>99</sup> EA ★ **S&H**



**SAVE 15%**  
**NOW \$89<sup>99</sup>**

## CABLE ATTACHMENT PACKAGE

PACKAGE INCLUDES 1 OF EACH

- 20" rotating straight bar
- Tricep lat rope
- "V" shaped press down bar

**1051377** \$89<sup>99</sup> PACK ★





### POWER RAM SLED HACK-MACHINE/LEG PRESS

- This three-way ram sled develops all muscle groups from the lower back and down, including hips, thighs and calves
- 4 start-stop locations to accommodate various height users
- The 85 lb. carriage glides smoothly at a 45 degree angle on 4 precision linear bearings
- Constructed of 2" x 3" heavy wall steel tubing
- Pads are constructed of 2.5" high density foam with Black marine grade vinyl
- Adjustable backrest/footrest to ensure proper angle for exercises
- Equipped with safety catches that can be engaged by user from any position
- 51"H x 32.5"W x 90"D - 400 lbs.

816702

\$2,599<sup>99</sup> EA ★ 



### FIELD HOUSE LEG PRESS

- Constructed of 2" x 3" heavy wall steel tubing
- Pads are constructed of 2.5" high density foam with Black marine grade vinyl
- Delivers a full range of motion with smooth precision pillow block bearings
- Heavy duty rubber bump stops for quiet operation
- Includes 2 weight storage horns with protective sleeves
- 1200 lb. weight capacity
- 59"H x 32"W x 84"L - 480 lbs.

814202

\$2,199<sup>99</sup> EA ★ 



### GLUTE/HAM MACHINE

- Constructed of 2" x 3" heavy wall steel tubing
- Pads are constructed of 2.5" high density foam with Black marine grade vinyl
- Strengthens lower back, hamstrings and core
- Foot pads adjust vertically and horizontally to fit all size users
- Equipped with knee pads to aid with mounting and dismounting
- Includes rear handle used for reverse hyper extensions
- 42"H x 34"W x 60"L - 196 lbs.

814102

\$841<sup>99</sup> EA ★ 



### LEG EXTENSION/CURL MACHINE

- Constructed of 2" heavy wall steel tubing
- Pads are constructed of 2.5" high density foam with Black marine grade vinyl
- Ideal for complete leg conditioning and strengthening of knee, thighs and hamstrings
- Features special split pad that allows for the proper isolation of the muscles
- Can be used for leg extension exercises in the sit-up position and leg curls in the prone position
- 38"H x 24"W x 80"L - 110 lbs.

813102

\$649<sup>99</sup> EA ★ 



### CHIN & DIP STATION

- Constructed of 2" square heavy wall steel tubing
- Multi-grip pull up bar combined with heavy duty dip bar supports with built in step ups
- All welded end caps with tabs for bolting to floor
- 90"H x 26"W x 64"D - 150 lbs.

**814800** \$499<sup>99</sup> EA ★ 



### AB EXERCISER, DIP & SIT UP BOARD COMBO

- Constructed of 2" square heavy wall steel tubing
- Use for bent knee raises, straight leg lifts or dips
- Built with 75 degree angle to target abdominal muscles
- Pads are 2.5" high density foam with 40 oz. Black marine grade vinyl
- All welded end caps with tabs for bolting to floor
- 67"H x 25"W x 64"D

**814502** Ab/Dip Only \$539<sup>99</sup> EA ★   
**814602** Combo \$899<sup>99</sup> EA ★ 

### BACK & ABDOMINAL EXERCISE BENCH

- Constructed of 2" square heavy wall steel tubing
- Combines hyper extension and Roman chair exercises for the abdomen and lower back
- Adjustable design to accommodate user height
- Pads are 2.5" high density foam with 40 oz. Black marine grade vinyl
- 29.5"H x 36"W x 49.5"D - 93 lbs.

**816502** \$449<sup>99</sup> EA ★ 



### ADJUSTABLE SIT UP BOARD

- Constructed of 2" x 3" heavy wall steel tubing
- 6 spring loaded pin positions from 0° - 30° incline
- 16"W x 44"L board is 2.5" high density foam with 40 oz. Black marine grade vinyl
- Ankle and knee supports are fully padded for comfort
- 45"H x 22.5"W x 66.5"L - 63 lbs.

**813302** \$379<sup>99</sup> EA ★ 



### HEAVY DUTY LEATHER DIP BELT

- Constructed of heavy-duty leather and steel chain
- Belt is 29"L and chain is 24"L
- Weight plate not included

**CHDBXXXX** \$81<sup>99</sup> EA ★



### CHIN/DIP/AB STATION

- Constructed of 2" square heavy wall steel tubing
- Multi-grip pull up bar on one side and dip bar and knee raise grips on the other side allows two athletes to exercise simultaneously
- Pads are constructed of 2.5" high-density foam with 40 oz. Black marine grade vinyl
- All welded end caps with tabs for bolting to floor
- 90"H x 26"W x 64"D - 180 lbs.

**814702** \$649<sup>99</sup> EA ★ 

# NAUTILUS®

## TRUSTED STRENGTH

It's no secret that working out with plates is one of the most effective ways to train and condition, but it's what you do with those weights that makes all the difference. Designed to make working out with plates as effective, rewarding and safe as possible, our Plate Loaded line occupies its own unique place in training and on your facility floor. With industry standard designs like our Leg Press and Hack Squat, we helped set the benchmark for traditional plate loaded machines.



**TILT SEAT CALF PLATE LOADED**

1459460

\$1,299<sup>99</sup> EA



**HACK SQUAT PLATE LOADED**

1459461

\$3,999<sup>99</sup> EA



**GLUTE DRIVE PLATE LOADED**

1459462

\$3,599<sup>99</sup> EA



**ANGLED LEG PRESS PLATE LOADED**

1459463

\$3,899<sup>99</sup> EA



# NAUTILUS®

TRUSTED STRENGTH

**EASY TO USE. EASY ON SPACE.**

Welcoming to users of all levels, Instinct® Strength is a full line of intuitive machines with easy adjustments and Lock N Load® weight selection system, offering users a quick and complete workout. Perfectly suited to be a basic strength line or circuit system, Instinct effectively complements more specialized lines. The versatility of Instinct's small footprint also lets you get the most from minimal space, while blending seamlessly with the Instinct Benches & Racks for a cohesive facility look.



FRAME SHOWN IN -60°



**INSTINCT LEG PRESS / CALF RAISE**

3 Year Limited Warranty

1459441

\$5,449<sup>99</sup> EA



FRAME SHOWN IN -60°



**INSTINCT LEG EXTENSION / SIDE LEG CURL**

3 Year Limited Warranty

1459442

\$3,949<sup>99</sup> EA



FRAME SHOWN IN -60°



**INSTINCT INNER / OUTER THIGH**

3 Year Limited Warranty

1459443

\$3,949<sup>99</sup> EA



FRAME SHOWN IN -60°



**INSTINCT DUAL ADJUSTABLE PULLEY**

3 Year Limited Warranty

1459444 \$5,449<sup>99</sup> EA



FRAME SHOWN IN -60°



**INSTINCT PEC FLY / DELTOID**

3 Year Limited Warranty

1459445 \$3,849<sup>99</sup> EA

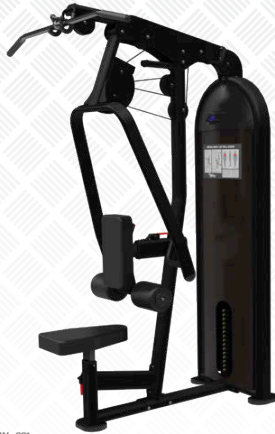

FRAME SHOWN IN -60°



**INSTINCT LAT PULLDOWN / LOW ROW**

3 Year Limited Warranty

1459447 \$3,849<sup>99</sup> EA



FRAME SHOWN IN -60°



**INSTINCT MULTI-PRESS**

3 Year Limited Warranty

1459446 \$3,849<sup>99</sup> EA



FRAME SHOWN IN -60°



**INSTINCT BICEPS / TRICEPS**

3 Year Limited Warranty

1459448 \$3,849<sup>99</sup> EA



FRAME SHOWN IN -60°



**INSTINCT ABS / LOW BACK**

3 Year Limited Warranty

1459449 \$3,849<sup>99</sup> EA



FRAME SHOWN IN -60°



**INSTINCT LEG EXTENSION, SIDE MOUNT**

3 Year Limited Warranty

1459450

\$3,949<sup>99</sup> EA



FRAME SHOWN IN -60°



**INSTINCT SEATED LEG CURL**

3 Year Limited Warranty

1459451

\$3,949<sup>99</sup> EA



FRAME SHOWN IN -60°



**INSTINCT GLUTE MACHINE**

3 Year Limited Warranty

1459452

\$3,949<sup>99</sup> EA



FRAME SHOWN IN -60°



**INSTINCT VERTICAL CHEST PRESS**

3 Year Limited Warranty

1459453

\$3,949<sup>99</sup> EA







**NAUTILUS**  
TRUSTED STRENGTH

FRAME SHOWN IN -60°

### INSTINCT LAT PULL DOWN

3 Year Limited Warranty

1459454

\$3,949<sup>99</sup> EA



**NAUTILUS**  
TRUSTED STRENGTH

FRAME SHOWN IN -60°

### INSTINCT VERTICAL ROW

3 Year Limited Warranty

1459455

\$3,949<sup>99</sup> EA



**NAUTILUS**  
TRUSTED STRENGTH

FRAME SHOWN IN -60°

### INSTINCT BICEPS CURL

3 Year Limited Warranty

1459457

\$3,949<sup>99</sup> EA



**NAUTILUS**  
TRUSTED STRENGTH

FRAME SHOWN IN -60°

### INSTINCT SHOULDER PRESS

3 Year Limited Warranty

1459456

\$3,949<sup>99</sup> EA



**NAUTILUS**  
TRUSTED STRENGTH

FRAME SHOWN IN -60°

### INSTINCT TRICEPS EXTENSION

3 Year Limited Warranty

1459458

\$3,949<sup>99</sup> EA



**NAUTILUS**  
TRUSTED STRENGTH

FRAME SHOWN IN -60°

### INSTINCT ROTARY TORSO

3 Year Limited Warranty

1459459

\$3,949<sup>99</sup> EA



Each of our multi-stations have the smallest possible footprint, while combining the most essential elements from our strength lines. Add in great features like swiveling pulleys on the Lat Pull Down, Low Row and Triceps Press and fully adjustable pulleys on the Cable Crossover System, and you have an economical, space-saving equipment solution that doesn't look, feel or train like one.



**CROSS-OVER CABLES WITH ADJUSTABLE PULLEYS**

1459465

\$8,749<sup>99</sup> EA



FRAME SHOWN IN -60°



**5 STATION WITH ADJUSTABLE PULLEY**

1459467

\$16,349<sup>99</sup> EA

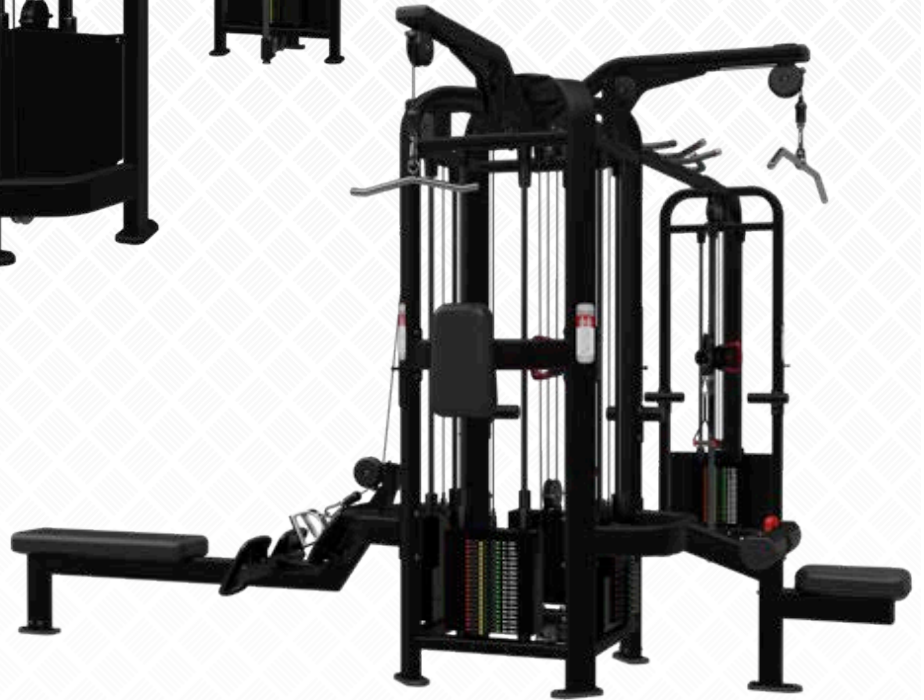

**CABLE ATTACHMENTS**

- |                    |                              |                         |
|--------------------|------------------------------|-------------------------|
| 1. <b>CHLBPROX</b> | 30" Pro-Style Lat Bar        | \$59 <sup>99</sup> EA ★ |
| 2. <b>CHLB481X</b> | 48" x 1" Lat Bar             | \$75 <sup>99</sup> EA ★ |
| 3. <b>CHLBHNDL</b> | Single Chrome Handle         | \$21 <sup>99</sup> EA ★ |
| 4. <b>CHLB2ORT</b> | Multi Purpose V-Bar          | \$39 <sup>99</sup> EA ★ |
| 5. <b>CHLBTRXX</b> | Nylon Triceps Rope           | \$40 <sup>99</sup> EA ★ |
| 6. <b>CHLBVPRS</b> | V Shaped Press Down Bar      | \$31 <sup>99</sup> EA ★ |
| 7. <b>CHLBMLTI</b> | Revolving Multi-Exercise Bar | \$50 <sup>99</sup> EA ★ |
| 8. <b>1101263</b>  | Nylon Ankle Strap            | \$24 <sup>99</sup> EA ★ |

Deluxe Cable Attachment Package  
(1 each of all of the above)

1382829

\$319<sup>99</sup> SET ★

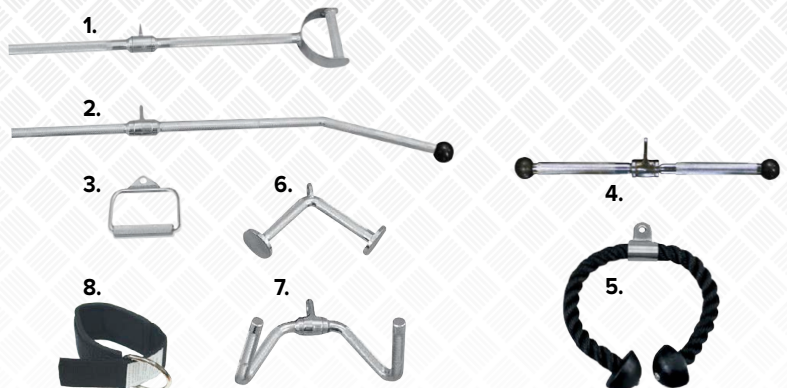

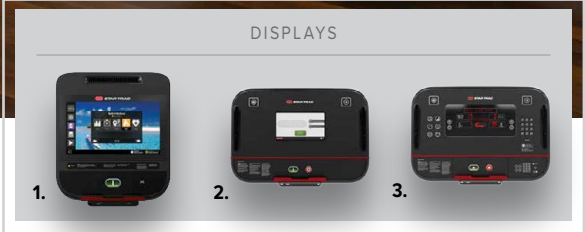
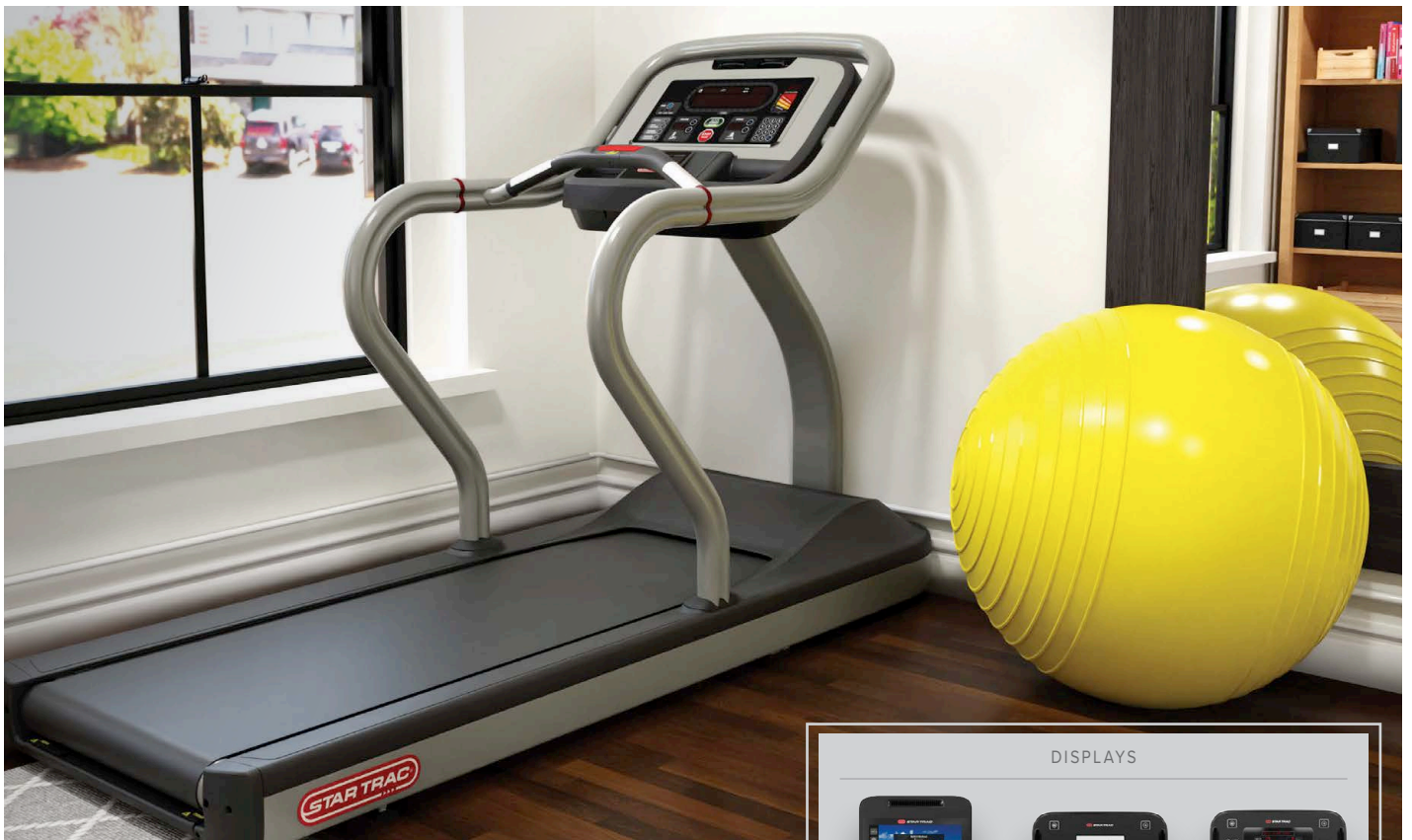

**STAR TRAC**  
MADE TO PERFORM

**4 SERIES TREADMILL**

- 1. 1459495 15" DISPLAY \$9,199<sup>99</sup> EA **S&H**
- 2. 1459496 10" DISPLAY \$5,749<sup>00</sup> EA **S&H**
- 3. 1459497 10" LCD \$4,649<sup>99</sup> EA **S&H**

MAX USER WEIGHT: 350 lbs.



**STAR TRAC**  
MADE TO PERFORM

**S-TRC TREADMILL**

- 1459493 MAX USER WEIGHT: 500 lbs. \$8,499<sup>00</sup> EA **S&H**

**S-TRX TREADMILL**

- 1459494 MAX USER WEIGHT: 350 lbs. \$8,049<sup>00</sup> EA **S&H**

**STAR TRAC**  
MADE TO PERFORM

**8 SERIES TRX TREADMILL WITH 10" DISPLAY**

- 1. 1459487 19" DISPLAY \$14,949<sup>00</sup> EA **S&H**
- 3. 1459489 LCD \$10,349<sup>00</sup> EA **S&H**

MAX USER WEIGHT: 500 lbs.



**STAR TRAC**  
MADE TO PERFORM

**8 SERIES TR TREADMILL**

- 1. 1459490 19" DISPLAY \$14,949<sup>99</sup> EA **S&H**
- 3. 1459492 10" LCD \$9,949<sup>00</sup> EA **S&H**

MAX USER WEIGHT: 500 lbs.



• Soft Trac® triple cell cushioning system provides maximum shockabsorption • 15% to 20% max incline 12.5 to 15 mph • Star Trac's popular personal fan for comfort  
 • USB port provides charging capability for user devices • Contact and telemetry heart rate • Lighter weight aluminum frame for maximum corrosion protection



**STAR TRAC**  
MADE TO PERFORM

- Ergonomic hand grips offer multiple hand positions and heart rate detection
- Articulating foot pads create a very comfortable and natural stride pattern
- Soft Trac® pedals provide ultimate shock-absorbing comfort throughout the entire workout
- 18" (47 cm) stride length
- Star Trac's popular personal fan for comfort
- Integrated USB port provides charging capability for user devices
- User weight capacity 350 lb (159 kg)
- Contact and telemetry heart rate

1. 1459498	15" Display	\$12,599.00 EA	
3. 1459500	10" LCD	\$8,149.00 EA	



**STAR TRAC**  
MADE TO PERFORM

**4 SERIES CROSS TRAINER**

1. 1459505	15" Display	\$8,049.00 EA	
2. 1459506	10" DISPLAY	\$4,649.00 EA	
3. 1459507	10" LCD	\$3,499.00 EA	



**STAR TRAC**  
MADE TO PERFORM

**S-CTX CROSS TRAINER**

1459504	\$6,099.00 EA	
---------	---------------	--



**STAR TRAC**  
MADE TO PERFORM

**8 SERIES CROSS TRAINER**

1. 1459501	15" Display	\$13,299.00 EA	
3. 1459503	10" LCD	\$9,199.00 EA	

• Efficient footprint and approachable, stable platform with minimal stepupheight for easy access from all angles  
 • Soft Trac® pedals provide ultimate shock-absorbing comfort throughout the entire workout • 18" TO 20" stride length • Star Trac's popular personal fan for comfort  
 • Integrated USB port provides charging capability for user devices • User weight capacity 350 lb • Contact and telemetry heart rate



**STAR TRAC**  
MADE TO PERFORM

**8 SERIES RECUMBENT BIKE**

1. 1459508	15" Display	\$10,349 <sup>00</sup> EA	
3. 1459510	10" LCD	\$5,749 <sup>00</sup> EA	



**STAR TRAC**  
MADE TO PERFORM

**4 SERIES RECUMBENT BIKE**

1. 1459512	15" Display	\$7,499 <sup>00</sup> EA	
2. 1459513	10" Touch Display	\$3,499 <sup>00</sup> EA	
3. 1459514	10" LCD	\$2,899 <sup>00</sup> EA	



**STAR TRAC**  
MADE TO PERFORM

**S-RBX RECUMBENT BIKE**

- Walk-through design and intuitive wrap-around seat adjust allow users to access and change seat position with ease
- Dual platform pedals with ratcheting straps provide user with option for secure hold or strap-free platform workout
- Armrests alleviate tension in the shoulders and allow for relaxed posture
- Morse Taper bottom bracket and pedal system
- Star Trac's popular personal fan for comfort
- User weight capacity 350 lb (159 kg)
- Contact and telemetry heart rate

1459511	\$4,049 <sup>00</sup> EA	
---------	--------------------------	--

DISPLAYS



**STAR TRAC**  
MADE TO PERFORM

**8 SERIES UPRIGHT BIKE**

1. 1459515	15" Display	\$9,899 <sup>00</sup> EA	
3. 1459517	10" LCD	\$5,299 <sup>00</sup> EA	



**STAR TRAC**  
MADE TO PERFORM

**4 SERIES UPRIGHT BIKE**

1. 1459519	15" Display	\$7,249 <sup>00</sup> EA	
2. 1459520	10" DISPLAY	\$3,499 <sup>00</sup> EA	
3. 1459521	10" LCD	\$2,899 <sup>00</sup> EA	



**STAR TRAC**  
MADE TO PERFORM

**S-UBX UPRIGHT BIKE**

- Dual platform pedals with ratcheting straps provide user with option for secure hold or strap-free platform workout
- Easy-up seat adjust for simple seat position changes
- Morse Taper bottom bracket and pedal system
- Star Trac's popular personal fan for comfort
- User weight capacity 350 lb (159 kg)
- Contact and telemetry heart rate

1459518	\$3,199 <sup>00</sup> EA	
---------	--------------------------	--



**CT800 LIGHT COMMERCIAL TREADMILL**

1364697

\$3,999<sup>99</sup> EA



Shown with Optional Infotainment Console



**SPIRIT FITNESS - CU800 UPRIGHT BIKE**

1364700

\$1,899<sup>99</sup> EA



**CE800 ELLIPTICAL**

1364698

\$3,499<sup>99</sup> EA



**CAB900 AIR BIKE**

- Console outputs: Speed - Watts - RPM - Distance - Time - Odometer - Power
- Ideal for HIIT training and general fitness
- Heavy Duty Steel Frame eliminates side-to-side movement
- Hybrid extra wide seat with multi-adjustment options - up/down - fore/aft
- Industrial powder coating for durability
- Reinforced pedals and crank 3 Year Limited Warranty

**3 Year Limited Warranty**

1451195

\$1,849<sup>99</sup> EA



### SCHWINN IC CLASSIC

- Indoor bike with flat pedals and cages
- Compatible with Schwinn Triple Link
- User height 4' 11" - 6' 8"
- 48" H x 20" W x 50" L
- User weight capacity 350lbs

2 Year Limited Warranty

1456010

\$1,649<sup>99</sup> EA



### SCHWINN AC SPORT GROUP CYCLE

- Carbon Blue™ durable toothed drive train provides an Authentic Cycling experience
- Magnetic Resistance Brake for zero drive train maintenance
- Optional 4iiii® crank arm powermeter delivers accurate strain gauge power feedback to help riders train harder and smarter.
- Optional Echelon2 Console provides immediate feedback to help riders train with results
- Morse Taper pedals for increased durability and reliability
- Schwinn Fit System enables versatile seat and handlebar adjustments for refined positioning
- Frame Finish - E-Coated & Powder Coated Steel
- Seat Slider, Handlebars, Hardware Materials - Stainless Steel

1459471

\$2,649<sup>99</sup> EA



### VELOCITY EXERCISE BIKE

- Heavy-duty adjustable spring/shock rider suspension for greater comfort
- Comfort gel saddle with mid-section cutaway for reduced seating pressure
- Ultra-smooth, quiet Poly-V Drive Belt system needs no-maintenance & can be tensioned without removing drive cover
- 47 lb. stainless flywheel in pillow-block bearing for super-fluid spinning
- Nonskid rubber feet can be adjusted for uneven surfaces
- Ergonomic triathlon-style handlebar offers multiple hand positions
- 55"H x 25"W x 44"L - 129 lbs.
- 300 lbs. maximum user weight 1 Year Limited Warranty



1205855

\$1,199<sup>99</sup> EA



### MOMENTUM EXERCISE BIKE

- Professional exercise bike designed for intensive use in institutions and gymnasiums
- 44 lb. flywheel weight
- Sleek look with protective flywheel cover
- Safe pinlocking seat
- Includes transport wheels for easy portability
- 55"H x 20"W x 43"L - 120 lbs.
- 275 lbs. maximum user weight 1 Year Limited Warranty



1272246

\$1,049<sup>99</sup> EA



### STAIRMASTER 10 SERIES

- Available with 3 OpenHub™ console options
- OverDrive Training Mode simulates carrying or pushing a load up stairs for an all-new level of HIIT workout
- Widest, deepest step in the industry and lowest step up height
- Redesigned handrail system supports a variety of workout positions including push/carry in new OverDrive Training Mode and optimal entry/exit
- Service panel removes with 4 fasteners, allows easy access to drive train and electronics
- Hand rail mounted stop button, level controls and contact heart rate
- Electronically controlled alternator, brake, and drive chain precisely control the stair speed, allowing a wide range of users to exercise smoothly within their comfort zones
- Revolving staircase with eight steps. Step surface: 8" (20cm) high, 9" (23 cm) deep and 22" (56 cm) wide.
- Step rate: 24-162 steps per minute
- User weight capacity 350 lb (159 kg)

1459473	15" Display	\$18,349 <sup>00</sup> EA	
1459474	10" DISPLAY	\$14,899 <sup>00</sup> EA	
1459475	10" LCD	\$13,299 <sup>00</sup> EA	



### STAIRMASTER 8 SERIES FREECLIMBER

- Available with 3 OpenHub™ console options
- 10 programs - Quick Start, Manual, Fat Burner, Calorie Burner, Speed Intervals, Custom Intervals, Random Intervals, Heart Rate Intervals, Calorie Goal, Heart Rate Zone Trainer
- Electronically controlled alternator with chain drive precisely controls the pedal descent allowing a wide range of users to exercise smoothly within their comfort zones
- Patented independent pedal geometry with four-bar linkage keeps pedals level ensuring a comfortable, biomechanically correct movement
- Step range 1" to 14" (2.5 cm to 36 cm)
- Step rate: 26-174 steps per minute

1459479	15" Display	\$11,449 <sup>00</sup> EA	
1459480	10" DISPLAY	\$9,199 <sup>00</sup> EA	
1459481	10" LCD	\$7,149 <sup>00</sup> EA	



### STAIRMASTER 8 SERIES GAUNTLET

- Available with 3 OpenHub™ console options
- Hot bar with stop button, heart rate, and level control
- Electronically controlled alternator, brake, and drive chain precisely control the stair speed, allowing a wide range of users to exercise smoothly within their comfort zones
- Revolving staircase with eight steps. Step surface: 8" (20cm) high, 9" (23 cm) deep and 22" (56 cm) wide.
- Step rate: 24-162 steps per minute
- User weight capacity 350 lb (159 kg)

1459476	15" Display	\$14,899 <sup>00</sup> EA	
1459477	10" DISPLAY	\$12,199 <sup>00</sup> EA	
1459478	10" LCD	\$9,899 <sup>00</sup> EA	



### STAIRMASTER HIIT BIKE

- Dual-action wind resistance provides a total body workout
- HIIT console with easy to read backlit display, Bluetooth & ANT+ connectivity, and programmable time, distance, calories, time interval, and calorie interval programs
- Robust, heavy gauge welded steel construction
- The StairMaster HIIT Bike™ was given a warm welcome at the CrossFit Games where it put the toughest among us to the test
- Backed by a full commercial warranty
- User compatible size range typically 4'11" to 6'8" (150 to 203 cm) tall
- User weight capacity 350 lb (159 kg)

1459483		\$2,999 <sup>00</sup> EA	
---------	--	--------------------------	--



### STAIRMASTER HIIT ROWER

- StairMaster HIIT console
- Isokinetic fan resistance offers unlimited workout options
- Fan dampening system allows for increased or decreased workloads at a given stroke rate
- Water bottle and accessory holder located under foot plates for safe storage
- Easy storage while not in use by disconnecting at center point
- User weight 500 lb as tested by CORE / 350 lb as tested per EN 20957-7
- Power two C cell batteries or an optional external power supply can be ordered
- Drive Train Nickel plated steel chain
- Construction Aluminum and Steel
- Electrostatic Powder Coating for long lasting durability

1459485		\$2,099 <sup>00</sup> EA	
---------	--	--------------------------	--





**StairMaster**  
THIS IS HIIT

**STAIRMASTER HIITMILL X**

- Self-powered walking, running and pushing
- Magnetic resistance brake
- Multi-grip hand positioning
- Portable design
- Water bottle and phone holder
- Accessory attachment points (straps and tubing not included)
- Farmer's Carry lift arms
- 3mm cushioned turf belt compatible with plastic field cleats
- HIIT console with easy to read backlit display, Bluetooth & ANT+ connectivity, and programmable time, distance, calories, time interval, and calorie interval programs

1459482

\$6,899<sup>00</sup> EA



**StairMaster**  
THIS IS HIIT

**STAIRMASTER HIIT UBE**

- Adjustable tower accommodates a wide variety of workouts and usersizes
- Integrated bench for seated workouts can be removed to accommodate standing or wheelchair workouts
- Adjustable cranks for varied range of motion and bilateral or unilateral motions
- HIIT console with easy to read backlit display, Bluetooth & ANT+ connectivity, and programmable time, distance, calories, time interval, and calorie interval programs
- Wheelchair accessible ramp option allows wheelchair access and meets ADA criteria. The removable ramp's unique mounting system adds only 22" (56 cm) to the total length of the machine
- User weight capacity 350 lb (159 kg)

1459484

\$4,499<sup>00</sup> EA



**TRUEFORM**  
TRAINER

**TRUEFORM TRAINER**

- Trainer curve is so shallow, users feel safe and in control of their speed, whether walking, jogging, or running.
- LCD is compatible with Polar heart rate monitor T31
- Dimensions: 64" x 36" x 63"
- Unit Weight: 340lb
- Max Weight: 500lb

1460523

\$4,995<sup>99</sup> EA



**TRUEFORM**  
TRAINER

**TRUEFORM RUNNER**

- The TrueForm Runner is the most natural running treadmill ever made and proven to dramatically improve run form by reducing impact stress, reducing asymmetry, increasing efficiency, and reducing the risk of injury.
- Dimensions: 64" x 36" x 63"
- Unit Weight: 340lb
- Max Weight: 500lb

1460524

\$7,399<sup>99</sup> EA



**TRUEFORM**  
TRAINER

**TRUEFORM OFFICE CRUISER**

- The Cruiser has the exact same base as the TrueForm Runner with a handrail design open in the front to accommodate most walking desk mode.
- Dimensions: 64" x 36" x 63"
- Unit Weight: 340lb
- Max Weight: 500lb

1460525

\$7,299<sup>99</sup> EA

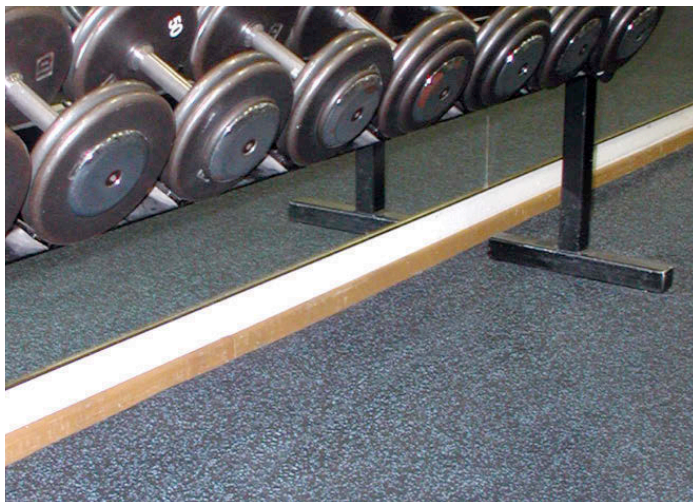

### SPORT ROLL FLOORING

- 100% recycled rubber rolls specially designed and manufactured for durability
- Serve as an effective buffer against acoustical vibration
- Suitable for both interior, exterior applications - ideal for surfacing areas that require resilience, sound absorption, spike resistance and traction
- Rolls are 3/8" thick and 4" wide and available in 25', 50' and 75' lengths
- Flec rolls contain 17% EPDM color flecs
- Adhesives are necessary; Failure to use recommended adhesives may void warranty

1008500	4"W x 25'L x 3/8" - Black	\$399 <sup>99</sup> EA
1377217	4"W x 25'L x 3/8" - Specify Color	\$449 <sup>99</sup> EA
1008388	4"W x 50'L x 3/8" - Black	\$599 <sup>99</sup> EA
1379866	4"W x 50'L x 3/8" - Specify Color	\$899 <sup>99</sup> EA
1008449	4"W x 75'L x 3/8" - Black	\$999 <sup>99</sup> EA
1379873	4"W x 75'L x 3/8" - Specify Color	\$1,102 <sup>99</sup> EA

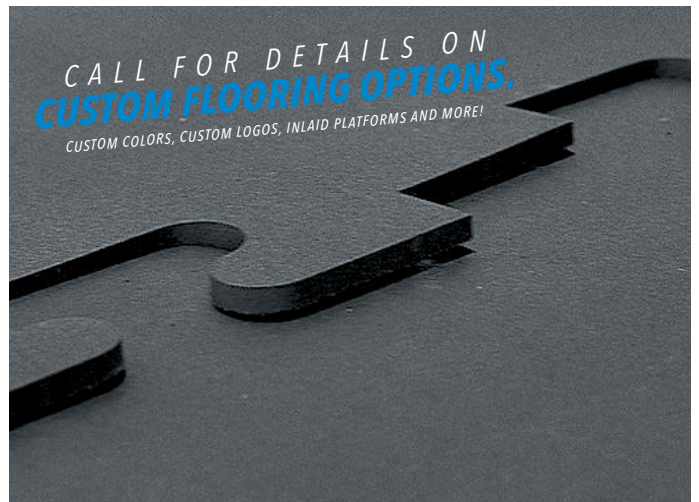
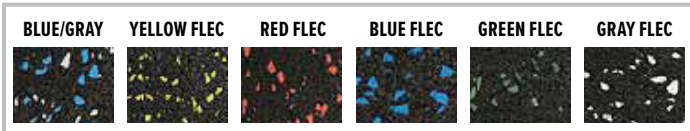

CALL FOR DETAILS ON  
**CUSTOM FLOORING OPTIONS.**  
CUSTOM COLORS, CUSTOM LOGOS, INLAID PLATFORMS AND MORE!



### MEGA-LOCK & FLEC-LOCK INTERLOCKING WEIGHT ROOM FLOORING

- Pieces are 30" x 30" x 1/2" thick
- Precision cut, seamless appearance, interlocking mat that is large enough to not require adhesive, but still small enough to be manageable
- Highly resilient, anti-fatigue qualities found naturally in rubber are enhanced by a space age polymer binder used during manufacturing

20015530	Mega-Lock Black - Center	\$46 <sup>99</sup> EA
20015532	Mega-Lock Black - Edge	\$46 <sup>99</sup> EA
20015531	Mega-Lock Black - Corner	\$46 <sup>99</sup> EA
20015533	Flec-Lock Colors - Center	\$46 <sup>99</sup> EA
20015535	Flec-Lock Colors - Edge	\$46 <sup>99</sup> EA
20015534	Flec-Lock Colors - Corner	\$46 <sup>99</sup> EA

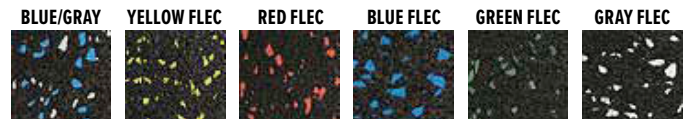

### ZIP-TILE INTERLOCKING FLOORING

- Interlocking 3/8" thick tiles are easy to handle and install
- Tiles are 28.5" x 28.5" with no corner or edge pieces required; simply cut tiles to fit any room
- Unique tab design holds the tiles together, eliminating the need for adhesives or tape



1300154	Black	\$29 <sup>99</sup> EA
1300161	Specify Flec Color	\$35 <sup>99</sup> EA

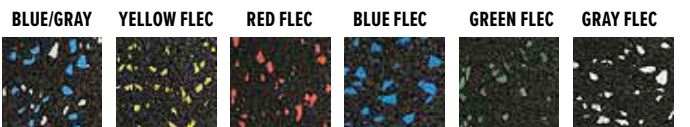

### ATHLETIC FLOORING MATS

- A cost effective alternative to other types of expensive flooring
- Protect floor from damage caused by the impact from dropping barbells

CHMAT1/2	3"W x 4'L x 1/2"	\$49 <sup>99</sup> EA
CHMAT3/4	3"W x 4'L x 3/4"	\$58 <sup>99</sup> EA
CHMTF1/2	4"W x 6'L x 1/2"	\$98 <sup>99</sup> EA
CHMTF3/4	4"W x 6'L x 3/4"	\$109 <sup>99</sup> EA



### RB FLOORING/MAT CLEANER

- Highly concentrated, phosphate-free formula designed to work with all of RB Rubber flooring systems
- Provides an economical, effective cleaning and deodorizing system for rubber, urethane and other inanimate hard surfaces and synthetic floors in areas that are normally hard to keep fresh smelling such as gyms, schools, clubs and indoor recreation facilities



20015536	\$44 <sup>99</sup> GAL
----------	------------------------

### CX-941 POLYURETHANE ADHESIVE FOR ROLLOUT RUBBER FLOORING

- CX-941 is a polyurethane-based, structural, trowel grade industrial adhesive
- Elastomer properties enable it to move with rubber as it expands and contracts

1008326	5 Gallon Pail	\$412 <sup>99</sup> EA
---------	---------------	------------------------

Adhesives are only necessary for rolled flooring. Failure to use recommended adhesives may void warranty.



**REACTOR**  
CHAMPION BARBELL

**WORKOUT BAR STORAGE RACK**

- 16-gauge powder coated rectangular tube and cold rolled steel construction
- Some assembly required
- Holds up to 35 bars depending on size

**1205572** 41.5"H x 24.25"W x 20"D \$249<sup>99</sup> EA ★



**REACTOR**  
CHAMPION BARBELL

**WORK OUT BAR**

- 48" long weighted steel bars
- Rubber coated foam covers bars for easy grip while exercising
- Great for incorporating into squats, lunges, dead lifts, bicep curls and dead rows
- Color coded sizes for easy identification

<b>1266467</b>	4 lb.	\$35 <sup>99</sup> EA ★
<b>1266474</b>	6 lb.	\$42 <sup>99</sup> EA ★
<b>1266481</b>	9 lb.	\$47 <sup>99</sup> EA ★
<b>1266498</b>	12 lb.	\$52 <sup>99</sup> EA ★
<b>1266504</b>	15 lb.	\$57 <sup>99</sup> EA ★
<b>1266511</b>	18 lb.	\$75 <sup>99</sup> EA ★



**REACTOR**  
CHAMPION BARBELL

**VERTICAL MEDICINE BALL RACK**

- Heavy duty square steel construction with durable black powder coated finish
- Holds 5 balls

**1033267** 66"H x 16"W x 25"D \$139<sup>99</sup> EA ★



**REACTOR**  
CHAMPION BARBELL

**2-SIDED MEDICINE BALL RACK**

- Heavy duty square steel construction with durable black powder coated finish
- Holds 8 balls

**1033250** 58"H x 24"W x 30"D \$169<sup>99</sup> EA ★ **SAH**



**REACTOR**  
CHAMPION BARBELL

**ROLLING MEDICINE BALL RACK**

- 6 tiers, holds 24 medicine balls
- Holds balls up to 16" in diameter
- Silver powder coated finish
- 4 heavy-duty lockable swivel casters

**1367628** 72"H x 29"W x 29"D \$549<sup>99</sup> EA ★ **SAH**

**Mueller**

**WHIZZER®**

- Multipurpose concentrate kills HIV-1 (AIDS virus), MRSA, Hepatitis B & C, and other viruses. Kills strep, staph and fungus germs on contact.
- Cleaner, fungicide, mildewstat, virucide and deodorizer - all in one. Comes complete with 2 FREE Pint spray bottles.
- Economical. One ounce of concentrate mixed with water makes a gallon of full-strength disinfectant. 128 dilutions per gallon.
- Fast. Apply directly to mats, floors, walls, training tables, locker rooms, or personal items. Just wipe dry.

**30 Day Limited Warranty**

**MU230201** 1 Gallon + 2 FREE Pint Spray Bottles \$94<sup>99</sup> CASE



**REACTOR**  
CHAMPION BARBELL

**AEROBAR**

- Rather than lifting static weight, user resists the force of moving weight
- Provides up to 250 muscle contractions per minute
- Great for general fitness, sport-specific training, rehab, strength and aerobic conditioning
- Heavy-duty composite material with comfort grip handle and padded rubber safety tips

**1369601** 48"L \$39<sup>99</sup> EA ★

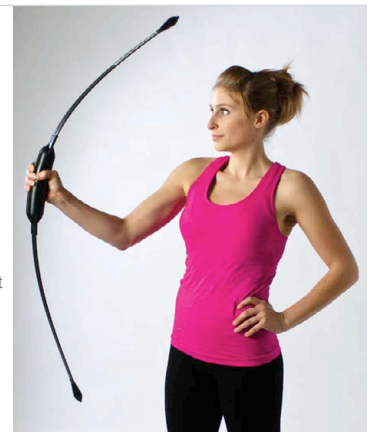

# REACTOR

by CHAMPION BARBELL™



## VINYL COATED KETTLEBELLS

• Vinyl coated to protect flooring and reduce noise

<b>1266818</b>	10 lb. - Light Blue	\$41 <sup>99</sup> EA ★
<b>1266825</b>	15 lb. - Red	\$62 <sup>99</sup> EA ★
<b>1267280</b>	20 lb. - Yellow	\$80 <sup>99</sup> EA ★
<b>1267297</b>	25 lb. - Royal	\$99 <sup>99</sup> EA ★
<b>1267303</b>	30 lb. - Orange	\$115 <sup>99</sup> EA ★
<b>1267310</b>	35 lb. - Kelly Green	\$137 <sup>99</sup> EA ★
<b>1267327</b>	40 lb. - Purple	\$153 <sup>99</sup> EA ★
<b>1267334</b>	45 lb. - Black	\$190 <sup>99</sup> EA ★

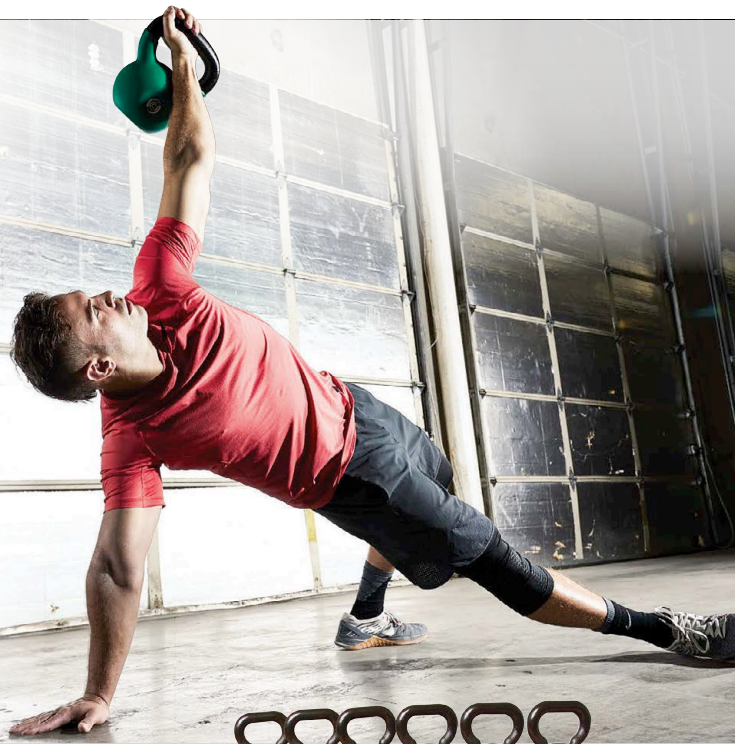

## RUBBER KETTLEBELLS

- All sizes (weights) are 8" diameter
- Combine strength training & muscle coordination training
- Develop muscle tone, strength and flexibility while promoting fat loss
- Effective for both upper and lower body work-outs

<b>1361735</b>	6 lb. - Light Blue	\$75 <sup>99</sup> EA ★	<b>1361780</b>	16 lb. - Green	\$119 <sup>99</sup> EA ★
<b>1361742</b>	8 lb. - Red	\$79 <sup>99</sup> EA ★	<b>1361797</b>	18 lb. - Purple	\$125 <sup>99</sup> EA ★
<b>1361759</b>	10 lb. - Yellow	\$85 <sup>99</sup> EA ★	<b>1361803</b>	20 lb. - Light Blue	\$139 <sup>99</sup> EA ★
<b>1361766</b>	12 lb. - Royal Blue	\$95 <sup>99</sup> EA ★	<b>1361810</b>	25 lb. - Red	\$155 <sup>99</sup> EA ★
<b>1361773</b>	14 lb. - Orange	\$109 <sup>99</sup> EA ★	<b>1361827</b>	30 lb. - Yellow	\$169 <sup>99</sup> EA ★



## KETTLEBELL STORAGE RACK

- Holds any size kettlebell on 3 shelves
- Back lip on each shelf prevents fall through
- Heavy-duty all steel construction

**1342611** 26"H x 45"W x 23"D \$314<sup>99</sup> EA ★



## KETTLEBELLS

- Combine strength training, muscle coordination and aerobic exercise all in one product
- Helps develop muscle tone, strength and flexibility while promoting fat loss
- Can be used for both upper and lower body workouts

<b>1266733</b>	10 lb.	\$37 <sup>99</sup> EA ★	<b>1266801</b>	45 lb.	\$151 <sup>99</sup> EA ★
<b>1266740</b>	15 lb.	\$51 <sup>99</sup> EA ★	<b>1455199</b>	53 lb.	\$185 <sup>99</sup> EA <b>SAH</b>
<b>1266757</b>	20 lb.	\$73 <sup>99</sup> EA ★	<b>1455200</b>	62 lb.	\$189 <sup>99</sup> EA <b>SAH</b>
<b>1266764</b>	25 lb.	\$86 <sup>99</sup> EA ★	<b>1455201</b>	71 lb.	\$202 <sup>99</sup> EA <b>SAH</b>
<b>1266771</b>	30 lb.	\$105 <sup>99</sup> EA ★	<b>1455202</b>	80 lb.	\$219 <sup>99</sup> EA <b>SAH</b>
<b>1266788</b>	35 lb.	\$125 <sup>99</sup> EA ★	<b>1455203</b>	88 lb.	\$227 <sup>99</sup> EA <b>SAH</b>
<b>1266795</b>	40 lb.	\$136 <sup>99</sup> EA ★	<b>1455204</b>	97 lb.	\$269 <sup>99</sup> EA <b>SAH</b>



## HANDHELD FITNESS BALLS

- Soft, weighted vinyl balls fit comfortably into the palm of the hand
- Incorporate into matwork routines to increase intensity and bring awareness to shoulder girdle stability or target desired muscle groups

<b>1266351</b>	1 lb. - Green	\$14 <sup>99</sup> EA ★
<b>1266368</b>	2 lb. - Red	\$16 <sup>99</sup> EA ★
<b>1266375</b>	3 lb. - Yellow	\$16 <sup>99</sup> EA ★
<b>1266382</b>	4 lbs. - Royal	\$18 <sup>99</sup> EA ★



# REACTOR

by CHAMPION BARBELL

## RUBBER MEDICINE BALLS

- Durable textured rubber cover makes them easy to grip
- Air filled with limited bounce
- Color coded sizes for easy identification
- Not designed for use in slamming exercises

<b>1266283</b>	2.2 lb. - Light Blue	\$43 <sup>99</sup> EA ★
<b>1266290</b>	4.4 lb. - Red	\$54 <sup>99</sup> EA ★
<b>1266306</b>	6.6 lb. - Yellow	\$64 <sup>99</sup> EA ★
<b>1266313</b>	8.8 lb. - Royal	\$75 <sup>99</sup> EA ★
<b>1266320</b>	11 lb. - Orange	\$109 <sup>99</sup> EA ★
<b>1266337</b>	13.2 lb. - Green	\$95 <sup>99</sup> EA ★
<b>1266344</b>	15.4 lb. - Purple	\$131 <sup>99</sup> EA ★
<b>1364666</b>	20 lb. - Gold	\$180 <sup>99</sup> EA ★
<b>1364664</b>	25 lb. - Maroon	\$192 <sup>99</sup> EA ★
<b>1364665</b>	30 lb. - Dark Green	\$225 <sup>99</sup> EA ★



# REACTOR

by CHAMPION BARBELL

## MEDICINE BALLS

- Traditional design, sizes and weights
- Synthetic leather cover
- Color coded sizes for easy identification
- Not designed for use in slamming exercises

<b>1266238</b>	4-6 lb. - Red	\$28 <sup>99</sup> EA ★
<b>1266245</b>	6-7 lb. - Yellow	\$38 <sup>99</sup> EA ★
<b>1266252</b>	9-10 lb. - Blue	\$46 <sup>99</sup> EA ★
<b>1266269</b>	11-12 lb. - Orange	\$50 <sup>99</sup> EA ★
<b>1266276</b>	15-16 lb. - Green	\$62 <sup>99</sup> EA ★
<b>1377213</b>	17-18 lb. - Purple	\$75 <sup>99</sup> EA ★
<b>1377214</b>	19-20 lb. - Yellow	\$89 <sup>99</sup> EA ★



## 14" WALL BALL

- Durable sewn polyester exterior withstands impacts
- Soft interior padding for easy grip
- Shell construction provides stable base
- 14" diameter

<b>1455185</b>	10 lb.	\$93 <sup>99</sup> EA
<b>1455186</b>	16 lb.	\$109 <sup>99</sup> EA
<b>1455187</b>	20 lb.	\$122 <sup>99</sup> EA

# REACTOR

by CHAMPION BARBELL

## SMASH BALLS

- Specifically designed to smash and slam without bouncing or rolling
- Durable textured cover to withstand the most demanding slam workouts
- Latex free PVC cover will not split or crack
- Sand filled center shifts with exercise movements to engage core and stabilizer muscles
- Ball diameter varies from 7" to 10" depending on weight

<b>1375501</b>	6 lb. - 7" Dia.	\$45 <sup>99</sup> EA ★
<b>1375502</b>	8 lb. - 7" Dia.	\$49 <sup>99</sup> EA ★
<b>1375503</b>	10 lb. - 7" Dia.	\$55 <sup>99</sup> EA ★
<b>1375504</b>	15 lb. - 9" Dia.	\$69 <sup>99</sup> EA ★
<b>1375505</b>	20 lb. - 9" Dia.	\$75 <sup>99</sup> EA ★
<b>1375506</b>	25 lb. - 9" Dia.	\$85 <sup>99</sup> EA ★
<b>1375507</b>	30 lb. - 10" Dia.	\$89 <sup>99</sup> EA ★
<b>1375508</b>	35 lb. - 10" Dia.	\$95 <sup>99</sup> EA ★



**BEST  
SELLER**



**AB WHEEL**

- Tones and strengthens the abdominals
- Double wheel for added stability

**MSABWHLX** \$25<sup>99</sup> EA ★



**POWERMAX  
PEGBOARD CLIMBERS**

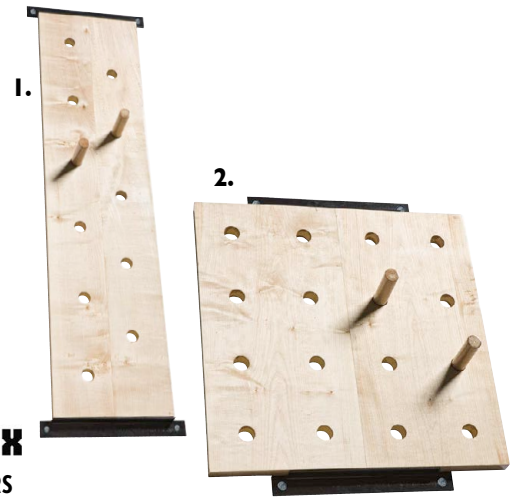

- Turn empty walls into active training and testing areas
- 1. • Pegboards provide challenge while increasing arm and shoulder strength
- 2. • Manufactured of 1 1/2" thick hardwood with clear coat varnish finish
- Comes complete with two hand-grip pegs
- Wall mounting brackets and replacement pegs sold separately

<b>1375518</b>	60"H x 15"W	\$715 <sup>99</sup> EA
<b>1375519</b>	30"H x 30"W	\$715 <sup>99</sup> EA
<b>1375520</b>	Mounting Bracket	\$229 <sup>99</sup> PR
<b>1375521</b>	Replacement Pegs	\$37 <sup>99</sup> PR



**REACTOR  
CHAMPION BARBELL  
AB MAT**

- Abdominal exerciser and core trainer supports lower back for proper positioning
- Safe, comfortable design to help prevent injury
- Designed to take anywhere

**1369609** \$31<sup>99</sup> EA



**WALL MOUNTED ADJUSTABLE PULL UP BAR**

- Powder coated solid steel bar and frame is adjustable in 6" increments within a 30" range
- Frame attaches to steel stringers and is removable for storage
- Bar is 40"L x 1" O.D. - 29 lbs.
- Stringers are each 54" long with mounting holes 24" apart; mount 37 1/2" center to center
- Mounting hardware not included

**1137286** \$278<sup>99</sup> EA ★



**LIFELINE POWER WHEEL**

- Place hands shoulder width apart or Feet in stirrups to more exercise options
- Patented Heavy Duty construction -13" Diameter Wheel & 22" Wide Handle allow
- Adjustable and secure foot straps and stirrups for quick on/off
- Comfortable, Soft foam grip limits hand fatigue

**60 Day Limited Warranty**

**1455217** \$59<sup>99</sup> EA

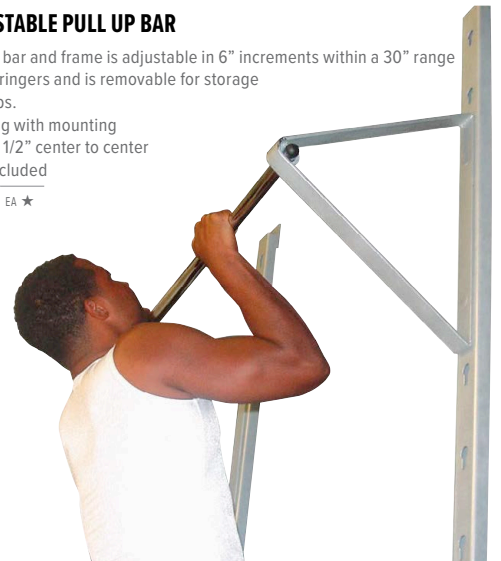

**NEW!**

**PRO KNIT HIP BAND**

- Comfortable fabric that stays in place during training and won't pinch or pull skin
- Can be used to add resistance during warmup and stretching
- Strong, durable fabric available in light, medium and heavy resistances
- Portable size, machine washable and easy to clean
- Bands measure 4'x13'



1461067 Heavy \$19.99 EA

**NEW!**

**PRO KNIT MINI BAND**

- Comfortable fabric that stays in place during training and won't pinch or pull skin
- Can be used to add resistance during warmup and stretching
- Strong, durable fabric available in medium and heavy resistances
- Portable size, machine washable and easy to clean
- Bands measure 2.5"x13"



1461068 Heavy \$14.99 EA  
1461069 Medium \$14.99 EA



**REACTOR**  
THE CHAMPION MARKER

**BODY LOOP BANDS**

- Closed loop design fits around the upper and lower legs
- 12" long loops are ideal for short, limited movements while the 22" long loops are suited for more dynamic movements with a greater range of motion

1301700	12" - Light - Orange	\$7.99 EA ★
1301717	12" - Light/Medium - Red	\$7.99 EA ★
1301724	12" - Medium - Blue	\$8.99 EA ★
1301731	12" - Heavy - Green	\$8.99 EA ★
1301755	22" - Light - Orange	\$11.99 EA ★
1301762	22" - Light/Medium - Red	\$12.99 EA ★
1301779	22" - Medium - Blue	\$13.99 EA ★
1301786	22" - Heavy - Green	\$16.99 EA ★



**STROOPS**

**SLASTIX® TONER**

- Slastix technology incorporates a Safety Sleeve that encloses latex tubing that protects it from wear, nicks and cuts
- Sleeve also provides safety stretch limitations during resistance training
- 4' long with comfortable handles on each end

GX52652	Very Light - Purple	\$22.99 EA
GL02615	Light - Yellow	\$25.99 EA
GL02616	Medium - Red	\$27.99 EA
GL02614	Heavy - Blue	\$29.99 EA
GX52651	Very Heavy - Green	\$31.99 EA



**TRAINER CABLES**

- Removable cable per handle for variable resistance
- Flexible, rotating handle allows for full range of motion and ergonomic rotation
- 10-50 lbs. peak resistance on each side

**60 Day Limited Warranty**

1455193	20 lbs - Purple	\$32.99 EA
1455194	30 lbs - Pink	\$29.99 EA
1455195	50 lbs - Orange	\$31.99 EA
1455196	70 lbs - Yellow	\$36.99 EA
1455197	90 lbs - Blue	\$39.99 EA
1455198	100 lbs - Black	\$41.99 EA

**CANDo®**  
**EXERCISE TUBES WITH HANDLES**

- Includes comfortable foam covered plastic handles
- Perform lower body, upper body and core conditioning exercises with our multi-use resistance tubes
- Isolate muscles or use as a full range of motion exerciser
- Choose from 5 levels of resistance and all are 48" long

1249798	X-Light - Yellow	\$11.99 EA
1249804	Light - Red	\$12.99 EA
1249811	Medium - Green	\$13.99 EA
1249828	Heavy - Blue	\$15.99 EA
1342574	X-Heavy - Black	\$15.99 EA

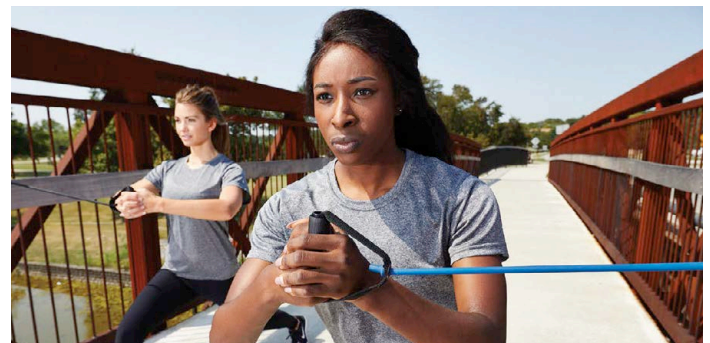



**REACTOR**  
CHAMPION BARBELL

**ANTI-BURST FITNESS BALLS**

- Target abs, back and glutes to strengthen and tone
- Advanced users position the ball for upper and lower body workouts
- Ideal for stretching and warm-up exercises
- Burst resistant up to 600 lbs.

<b>1335910</b>	45cm - Purple	<b>\$49<sup>99</sup></b> EA ★
<b>1335927</b>	55cm - Green	<b>\$52<sup>99</sup></b> EA ★
<b>1335934</b>	65cm - Yellow	<b>\$55<sup>99</sup></b> EA ★
<b>1337211</b>	75cm - Red	<b>\$59<sup>99</sup></b> EA ★

**REACTOR**  
CHAMPION BARBELL

**CORE STABILITY BALLS**

- Improve and maintain balance, coordination, posture and flexibility
- Strengthens hard-to-reach muscles often overlooked in normal training
- Use to perform a variety of balance, core, strength, flexibility and rehabilitation exercises

<b>1335873</b>	45cm - Purple	<b>\$35<sup>99</sup></b> EA ★
<b>1335880</b>	55cm - Green	<b>\$38<sup>99</sup></b> EA ★
<b>1335897</b>	65cm - Yellow	<b>\$45<sup>99</sup></b> EA ★
<b>1335903</b>	75cm - Red	<b>\$49<sup>99</sup></b> EA ★

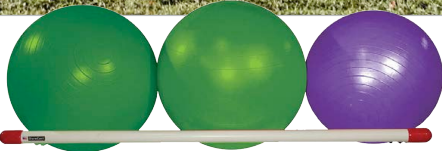

2.



1.

**STABILITY BALL STORAGE**

- Stores and safely transports stability balls with a diameter of 16" or larger, plus jump ropes, exercise bands and resistance tubes
- Lightweight PVC, yet strong, durable and maintenance free
- Roll lock casters secure cart in place with the push of a lever
- Easily passes through a standard doorway
- Wall mounted stability ball rack (mounting hardware not included)
- Conveniently holds 3 medium or 2 large fitness balls

1. <b>1257557</b>	Cart - 67"H x 67"W x 19"D	<b>\$519<sup>99</sup></b> EA
2. <b>1369556</b>	Wall Rack - 55"W x 18"D	<b>\$109<sup>99</sup></b> EA



**ECONOMY ELECTRIC INFLATOR**

- High impact plastic desktop inflator
- 120v and .9 amps
- 100 psi gauge
- Coiled inflation tube that will stretch to 30"
- Comes with needle and other inflation valves

**MSECOLEY** **\$129<sup>99</sup>** EA ★



**CANDO**  
**13" BALANCE DISK**

- Improves coordination, stability, posture and motor skills
- Resembles the sensation of the stability ball and works the core and stabilizer muscles in a more compact environment
- Place them in a chair to help support and challenge the spinal muscles while enhancing posture
- Use two discs for double arm and leg activities such as push ups and squats
- Uses standard needle inflation (pump included)
- Supports up to 350 lbs.



**1377189** Specify Color **\$29<sup>99</sup>** EA

**CANDO**  
**24" BALANCE DISK**

- Promotes core stability and provides many of the same benefits of a stability ball while performing lower back and abdominal exercises
- Support and challenge the spinal muscles while enhancing posture
- The tactile surface has been shown to enhance calmness and concentration
- Perform exercises while sitting, kneeling, or lying on top of the disc for dynamic stabilization training
- Inflation requires a standard foot or hand air pump (not included)
- Supports up to 450 lbs.



**1377194** Specify Color **\$59<sup>99</sup>** EA





### DUAL-DENSITY WORKOUT MAT

- Extra-tough Polyethylene mat for yoga, pilates, stretching and exercise
- Dual density foam is strong on the inside and soft on the outside
- Cut out carry handle

**1271027** 48"L x 24"W x 1" \$49.99 EA ★



### HANGING WORKOUT MATS

- Reinforced grommets allow mats to hang for storage

**1277159** 48"L x 20.5"W x 3/8" - Red \$49.99 EA ★  
**1277197** 72"L x 24"W x 5/8" - Blue \$79.99 EA ★



### GAMECRAFT® ACTIVITY MAT

- Durable but soft mat with a patented self-sealing foam will not tear, peel or split under normal use
- Mat can be stored flat or rolled up
- Water resistant for easy maintenance and comes with built-in handles

**7137XXXX** 48"L x 24"W x 3/8" \$32.99 EA ★

### HANGING MAT RACK

- Height and width adjustments allow this rack to work with different length and width hanging mats
- Constructed of 1.5" and 1.25" square steel tubing with Silver powder coated finish
- Holds up to 50 - 48" or 32 - 72" mats or a combination of both
- Equipped with 4 non-marring polyurethane swivel casters; 2 locking

**1378641** Cart Only 74"H x 28"W x 36"L - 39 lbs. \$255.99 EA ★  
**1388485** Cart + 24 Mats (48"L x 20.5"W x 3/8") \$999.99 PACK ★  
**1388486** Cart + 24 Mats (72"L x 24"W x 5/8") \$1,799.99 PACK ★



### PACMAT 100

- Composed of Nitrile™ rubber
- Offers maximum comfort and impact resistance
- The patented cellular foam will not crack, peel or tear under normal use
- Water resistant for easy maintenance

**PACMAT** 75"L x 24"W x 7/16" \$45.99 EA ★



**2' X 6' FOLDING**



### ECONOMY EXERCISE MATS

- Resilient foam covered with a durable vinyl
- Handles are at each end for easy carrying

**GCMAT261** 72"L x 24"W x 1" - Folding \$65.99 EA ★  
**GCMAT241** 48"L x 24"W x 1" - Non-Folding \$55.99 EA ★



**BEST  
SELLER**



### YOGA MAT

- Lightweight, durable sticky mat
- Cushioned non-slip surface
- Hand washable, air dry

**1240146** 68"L x 24"W x 1/8" **\$29<sup>99</sup>** EA ★



### CAN DO BALANCE PAD

- The CanDo Balance Pad combines both exercise and coordination skills
- Widely used for rehabilitation and sports conditioning
- Super soft, closed cell foam pad forces active recruitment of the foot's muscular system, increasing strength, stamina and mobility
- Impervious to water, easy to clean and long-lasting

**1388425** 20"L x 16"W x 2 1/2"D **\$59<sup>99</sup>** EA



### YOGA BLOCKS

- For additional support during transitions and poses
- Available in 3" or 4" thickness
- Blue only

**1301946** 3" Thick **\$19<sup>99</sup>** EA  
**1301953** 4" Thick **\$22<sup>99</sup>** EA



### RIBBED MULTI-PURPOSE MATS

- Closed cell foam is great for repelling water or stains
- Hygienic, easy to clean and easily rolled for storage
- Non-slip, hard-wearing and long lasting
- Warm and comfortable to the touch

**1022391** 56"L x 23"W x 3/4" - Red **\$55<sup>99</sup>** EA ★  
**1013047** 72"L x 39"W x 5/8" - Blue **\$85<sup>99</sup>** EA ★



### AEROBIC MAT

- The ideal stretching and exercise mat, durable yet soft
- Use for aerobics or under your yoga mat
- Beveled edges have sealed borders on all 4 sides
- Can be rolled for storage
- Black pebble finish

**1235005** 60"L x 24"W x 3/8" **\$49<sup>99</sup>** EA ★



### YOGA STRAPS

- Assists with achieving the proper pose or position
- Excellent tool for increasing flexibility
- Buckle allows you to adjust the strap length
- Available in 6' or 8' lengths

**1301922** 6' Long **\$15<sup>99</sup>** EA  
**1301939** 8' Long **\$18<sup>99</sup>** EA

### REACTOR CHAMPION BARBELL BARREL ROLLER

- This deep tissue roller has a molded plastic core for shape retention and is covered in a multi-textured thick rubber-foam
- The textured surface is great for both myofascial release and knotted-muscle trigger-point relief
- The hard plastic core allows for maximal weight application
- Available in Black only

**1388452** 5.5"H x 5.5"W x 15"L **\$39<sup>99</sup>** EA



### RECOVERY MASSAGERS

- Improve recovery time by targeting hard to reach muscles and injuries
- Perform deep tissue self-massage and increase blood flow to muscles
- Improve flexibility and range of motion in muscles

**1455214** Dual Massage Ball **\$18<sup>99</sup>** EA  
**1455215** Massage Bar **\$34<sup>99</sup>** EA

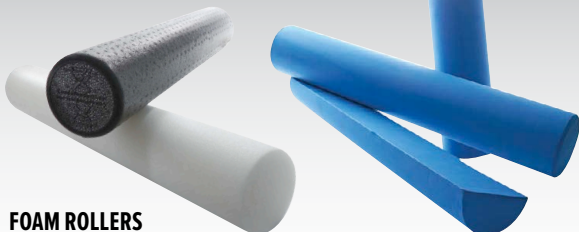

### FOAM ROLLERS

- Available in 3 firmness levels, medium-firm White PE foam, firm Blue EVA foam, extra-firm Black Molded foam
- Helps develop balance, postural alignment and flexibility
- Ideal for self-myofascial release and massage therapy

**1377211** White - 36" x 6" Round - Medium Firm **\$35<sup>99</sup>** EA  
**1277111** Blue - 36" x 6" Round - Firm **\$65<sup>99</sup>** EA ★  
**1277128** Blue - 18" x 6" Round - Firm **\$40<sup>99</sup>** EA ★  
**1377212** Black - 36" x 6" Round - Extra Firm **\$37<sup>99</sup>** EA



BOSU®



**BOSU® PRO TRAINER**

- Targets the core muscles of your body helping you to not only gain strength, trim, and tone, but to help coordinate your entire body
- Ideal for static and dynamic balance training
- Can also be used to integrate balance challenges into cardiovascular, endurance, core and flexibility training
- Can be used with the platform side either up or down to challenge balance with different body positions
- Includes a workout DVD, an inflation pump, a healthy diet guide for weight loss and a 120 page integrated balance training book
- Supports up to 300 lbs.
- 25" diameter x 12"H

1205732

For the Instructor

\$249<sup>99</sup> EA



**BOSU® POWER STAX**

- BOSU Stax increases the intensity of your workout at different heights
- Creates unlimited options for advanced exercises and explosive power and agility drills
- Each BOSU Stax measures 24"W x 3"H
- BOSU balance trainer sold separately

1375490

Single

\$130<sup>99</sup> EA

1375530

Set of 3

\$314<sup>99</sup> SET



**BOSU® SPORT BALANCE TRAINER**

- New, redesigned smaller version of the original BOSU Balance Trainer and is constructed with the same rim and base style
- The sleek, compact 22" design allows for easy transportation and storage, quick positioning for any type of workout and is ideal for fitness enthusiasts and athletes of all ages
- Includes inflation pump and owners manual
- 250 lbs. maximum user weight

Color Options: **Blue, Pink.**

1388422

Specify Color

\$149<sup>99</sup> EA



**BSN SPORTS™**

**PLYOMETRIC PLATFORM BSN**

- Great for improving explosiveness, speed, vertical jump and endurance
- Constructed of 1" O.D. 16-gauge, fully welded Black powder coated, square steel tubing
- Landing surface area varies by height of box
- Nesting stackable for compact easy storage
- 400 lbs. maximum user weight
- For indoor or outdoor use

1457905	12"H	\$195 <sup>99</sup> EA
1457906	18"H	\$206 <sup>99</sup> EA
1457907	24"H	\$226 <sup>99</sup> EA
1457908	30"H	\$260 <sup>99</sup> EA
1457909	36"H	\$305 <sup>99</sup> EA
1457910	42"H	\$339 <sup>99</sup> EA
1457911	Starter Set (1- 12, 18, 24, 30 in.)	\$685 <sup>99</sup> SET
1457912	Advanced Set (1- 12, 18, 24, 30, 36, 42 in.)	\$1,199 <sup>99</sup> SET



**HEAVY DUTY PLYO BOX SET**

- Set of 4 Plyo Boxes includes one of each: 12", 18", 24" and 30" high
- Stackable for easy storage
- Large 1 1/8" thick non slip landing surface
- Fully welded steel construction with gray powder coated finish
- Floor protectors for indoor or outdoor use
- Can be used by athletes up to 400 lbs.
- Ships fully assembled



**1258318**

\$999<sup>99</sup> SET ★



**FOAM PLYO BOXES**

- Large 30" x 36" landing surface eliminates athlete's fear of missing the box
- Constructed of 100% Naugahyde and premium density polyethylene foam that will not break down, de-laminate or soften over time
- Includes handles, Velcro tabs to secure boxes together and compression vents for air release
- Sold in sets of 3 only: 1 - 6", 1 - 12", 1 - 18"
- 3 in 1 Plyo Cube is 20"H x 24"W x 30"L
- Please be cautious when using plyo boxes on smooth or slick surfaces, boxes can move or slide

1461813	3" Plyo	\$149 <sup>99</sup> EA
1461814	24" Plyo	\$499 <sup>99</sup> EA
1455216	Set of 3	\$999 <sup>99</sup> SET
1461815	Set of 5	\$1,399 <sup>99</sup> SET
1455257	3 in 1 Plyo Cube	\$579 <sup>99</sup> EA





### LEATHER JUMP ROPE

- Ball bearing swivel and foam handles
- 9 1/2' long

**2549XXX**

**\$22<sup>99</sup>** EA ★



### REACTOR CHAMPION BARBELL

### CABLE SPEED ROPE

- 10'L Low-kink PVC coated steel cable rope
- 6"L lightweight plastic ergonomic handles
- Double bearings in the handle with easy change length feature

**1390925**

**\$22<sup>99</sup>** EA ★



### HEAVYWEIGHT SASH ROPES

- Thick sash cord jointed into well shaped hollow handles

**2546XXX**

8' **\$8<sup>49</sup>** EA ★



### WEIGHTED JUMP ROPES

- Durable with padded, swivel handles that allow rope to spin faster, reducing stress on wrists, elbows and shoulders
- 9' length

<b>1024135</b>	1lb. - Red	<b>\$38<sup>99</sup></b> EA ★
<b>1024142</b>	2lb. - Blue	<b>\$43<sup>99</sup></b> EA ★
<b>1024159</b>	3lb. - Green	<b>\$55<sup>99</sup></b> EA ★
<b>1024166</b>	4lb. - Orange	<b>\$60<sup>99</sup></b> EA ★

### REACTOR CHAMPION BARBELL

### 4" AND 6" FITNESS STEPS

- Constructed of high density polyethylene designed for schools, YMCA's, public recreational and health facilities
- Rounded corners reduce the risk of injury from rough edges
- Additional safety features include non-slip, dimpled top and non-skid bottom with rubber feet
- Top surface area is 24"L x 15"W

**1292619**

Orange 4" Step

**\$55<sup>99</sup>** EA ★

**1292626**

Grey 6" Step

**\$65<sup>99</sup>** EA ★



### REACTOR CHAMPION BARBELL

### FITNESS STEP CART

- Large capacity storage rack and transporter for fitness steps and resistance tubes
- Lightweight and durable
- This cart will safely store up to (32) 4" steps or (16) 6" steps plus resistance tubes
- Features include heavy-duty, ball bearing, swivel, non-marring casters with a roll lock feature
- Easily goes through standard doorway

**1188332**

60"H x 45"W x 19"D

**\$465<sup>99</sup>** EA

### LICORICE ROPES

- Perfect for beginners or experienced jumpers who want the best
- Great for speed jumping and a favorite with jump teams
- Injection molded handles designed for comfort and free spin
- Durable, plastic rope

**17207XXX**

Orange 7' Licorice

**\$5<sup>99</sup>** EA

**17208XXX**

Red 8' Licorice

**\$5<sup>99</sup>** EA

**17209XXX**

Green 9' Licorice

**\$5<sup>99</sup>** EA

**17210XXX**

Black 10' Licorice

**\$6<sup>99</sup>** EA



### REACTOR CHAMPION BARBELL

### POWER ROPE ANCHOR STATION

- Use indoors or outside
- Accommodates up to 12 users at one time
- Solid rubber bottom for floor protection
- Add up to 4 - 45 lb. Olympic weight plates for maximum stability
- All welded, all silver powder coated steel construction
- 6.5"H x 23.5"W x 23.5"D - 32 lbs.
- Power ropes and weight plates sold separately

**1375090**

**\$249<sup>99</sup>** EA ★



### FITNESS POWER ROPES

- Various lengths and diameters to enhance the overall work-out experience
- Great for grip strength, stamina and overall conditioning
- Ideal for upper body and core exercises

<b>1369620</b>	1.5"D - 30'L	<b>\$179<sup>99</sup></b> EA ★
<b>1369621</b>	1.5"D - 40'L	<b>\$226<sup>99</sup></b> EA ★
<b>1369622</b>	1.5"D - 50'L	<b>\$261<sup>99</sup></b> EA ★
<b>1369624</b>	2"D - 30'L	<b>\$273<sup>99</sup></b> EA ★
<b>1369625</b>	2"D - 40'L	<b>\$324<sup>99</sup></b> EA ★
<b>1369626</b>	2"D - 50'L	<b>\$377<sup>99</sup></b> EA ★

**BEST  
SELLER**

**REACTOR**  
CHAMPION BARBELL

**QUICK RELEASE TETHER**

- Combines fixed resistance with overload release for explosive speed training
- Partner-activated release frees tether from belt for a burst of speed
- Durable nylon mesh tether features reinforced stitching and a dual grip handles

**1301793** \$55<sup>99</sup> EA



**REACTOR**  
CHAMPION BARBELL

**POWER DRIVER**

- Connect together, back-to-back and attempt to pull the other while staying parallel to the ground
- Trains explosive position and allows hip flexors to fire at maximum velocity
- Includes two heavy-duty padded harnesses, a nylon mesh tether with reinforced stitching and easy-attach steel clips

**1301861** \$85<sup>99</sup> EA



**REACTOR**  
CHAMPION BARBELL

**DUAL RESISTANCE HARNESS**

- One athlete provides resistance while the other runs
- Running positions can be alternated quickly for interval training
- Adjustable 3" waist belt
- Includes carry bag

**1143591** \$71<sup>99</sup> EA ★



**REACTOR**  
CHAMPION BARBELL

**SHOULDER RESISTANCE HARNESS**

- Strong harness for developing maximum stamina, strength, and power for running in proper form
- 10'L handled tether attaches to shoulder harness with adjustable waist belt
- Includes carry bag

**1143584** \$88<sup>99</sup> EA ★



**REACTOR**  
CHAMPION BARBELL

**360° BELT SET**

- Continuous belts without buckle closures allow heavy-duty steel rings full rotation without hindrance
- Use to increase first-step explosion, back pedaling speed and lateral quickness
- Includes 5 belts (color-coded by size), 8' long latex cord in nylon sheathing, and a safety cuff that tethers to the wrist

**1301892** \$109<sup>99</sup> EA

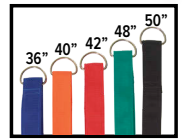
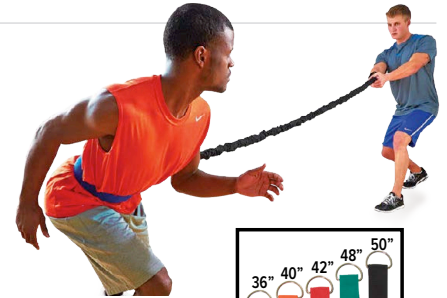

**REACTOR**  
CHAMPION BARBELL

**SPEED CHUTE**

- Provides excellent resistance while running to improve speed, stamina, strength and acceleration
- Chute releases while running to provide resistance
- Includes carry bag

<b>1143607</b>	40" Diameter	\$57 <sup>99</sup> EA ★
<b>1143614</b>	48" Diameter	\$66 <sup>99</sup> EA ★
<b>1273694</b>	54" Diameter	\$72 <sup>99</sup> EA ★



**REACTOR**  
CHAMPION BARBELL

**WEIGHT VEST**

- Great for speed and power training
- Secure and comfort fitting straps for maximum movement of your arms, shoulders, and neck
- Adjustable from 1 lb. to 20 lbs. (weight packs included)

**1369608** 20 lbs. \$89<sup>99</sup> EA ★



**REACTOR**  
CHAMPION BARBELL

**X-FINITY WEIGHT VEST**

- Comfortable form fitting ergonomic fitness vest
- Breathable design offers adjustable quick release chest buckle, reflective stripes (front and rear) and a secure pocket for your cell phone
- Do not machine wash or soak in water
- One size fits most

<b>1395594</b>	6 lb. - Grey	\$64 <sup>99</sup> EA ★
<b>1395595</b>	10 lb. - Black	\$81 <sup>99</sup> EA ★



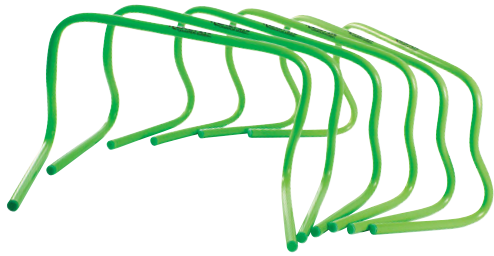

**REACTOR**  
CHAMPION BARBELL  
**BANANA STEPS**

- Molded tubular PVC construction
- Helps improve quickness and agility
- Designed to absorb impact or fall forward if struck, decreasing the likely hood of training related injuries
- 12"H x 17"W x 8"D
- Sold individually

**1390931** \$19<sup>99</sup> EA ★

**PORTaPiT**  
**MULTI-HEIGHT FLEX HURDLE**

- Lightweight multi-height flexible PVC hurdle can be converted into two heights 6" or 12" by folding legs in reverse directions
- Helps improve quickness and agility
- Hurdles can be positioned for plyometric jumps or running drills
- Sold in sets of 4

**1202076** \$84<sup>99</sup> SET OF 4 ★

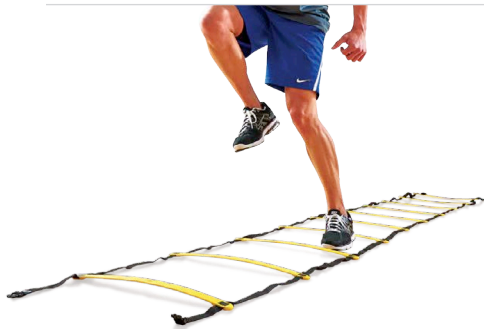

**REACTOR**  
CHAMPION BARBELL  
**FIXED RUNG AGILITY LADDER**

- Ideal for developing quick and accurate foot speed, increased balance and coordination
- Each ladder is 15'L x 20"W with ten sections
- Rugged 1" wide webbing with end buckles allow various shape configurations for a more diversified workout
- Connecting buckles allow for additional ladders for longer runs and different formations
- Includes carry bag

**1271560** \$53<sup>99</sup> EA ★



**REACTOR**  
CHAMPION BARBELL  
**LOW PUSH/PULL TRAINING SLED**

- Increase speed, explosion, leg strength and endurance
- Large radius handle allows for multiple grip locations
- 12"H x 2" O.D. post will hold up to 315 lbs. of Olympic plates (sold separately)
- One piece welded construction, 1.9" silver powder coated steel tubing
- Waist and shoulder harness is fully adjustable with quick release attachment and double safety tethers
- 14"H x 23"W x 38"L - 25 lbs

<b>1375098</b>	Sled and Harness	\$449 <sup>99</sup> EA ★
<b>1375084</b>	Sled Only	\$399 <sup>99</sup> EA ★
<b>1240054</b>	Harness and Tether Only	\$53 <sup>99</sup> EA ★



**JUKE 360**

- 8 ft stretch cord safely extends to 20 ft
- Adjustable belt with free slid ring for movement in any direction
- 10 different drill cards for training & practicing

**60 Day Limited Warranty**  
**1455208** \$41<sup>99</sup> EA



**HEXA RINGS**

- Snap together to create a variety of designs or connect to create a straight ladder
- Includes 6 hexagon pieces, 12 supporting pieces, and carrying bag
- Hexagon ladder size: 19"(L) x 21"(W)

**1454873** \$39<sup>99</sup> SET ★



**JUMP TRAINER**

- Padded adjustable belt and ankle straps fit most sizes comfortably
- Quick release power tubes are easily added and removed
- Durable latex tube construction to withstand dynamic exercises

**60 Day Limited Warranty**  
**1455212** \$41<sup>99</sup> EA

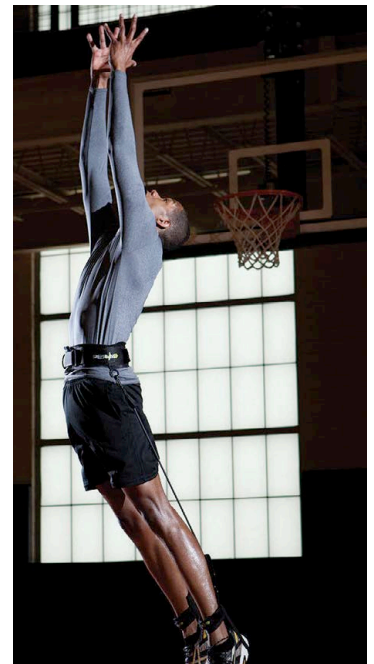



## PEDOMETERS AND ACCELEROMETERS



### ONE

- Perfect for your 10,000 step per day program.
- Includes: step counter w/ extra large digital display, hinged protective cover, loss prevention strap, spring-loaded alligator clip and user changeable battery
- Class Pack includes: 32 Pedometers, 32 loss prevention straps, and 2 storage cases

**5 Year Limited Warranty**

**1277210**

\$17<sup>99</sup> EA ★

**1377238**

One Class Pack of 32

\$619<sup>99</sup> PACK OF 32 ★



### THREE.5

- All of the same specifications as the Ekho "One.5" and "Two.5" plus activity time and calories
- Class Pack option includes: (32) accelerometers and (2) storage cases

**5 Year Limited Warranty**

**1376382**

\$21<sup>99</sup> EA ★

**1377243**

Class Pack

\$675<sup>99</sup> PACK OF 32 ★

## BEE-FIT PEDOMETERS

### BEE-FIT PEDOMETERS

- Meets NASPE Standards
- Busy Bee includes: counts steps, extra large digital display, durable construction with hinged cover, loss prevention strap, spring loaded alligator clip and user changeable batteries
- Worker Bee includes distance, activity time and calories
- Class Packs includes (2) 16 unit carrying cases

**5 Year Limited Warranty**

**1216769**

Worker Bee Yellow

\$20<sup>99</sup> EA ★



### HEART RATE MONITOR STICK

- "Stick" style pulse monitor with large sensor pads for an accurate reading
- Provides a readout of your pulse in 10 - 15 seconds
- Features a large, easy to read display screen
- Replaceable 9V battery

**1399689**

\$45<sup>99</sup> EA ★







### PUSH-UP CHALLENGER

- Provides the teacher and student an effective way to test each individual push up fairly and consistently, while teaching the proper mechanics of the push up
- The student lowers their body to touch their chest to the PUSH-UP CHALLENGER, almost guaranteeing their arms are at a right angle
- The push-up tester is now being used by many for Fitnessgram
- Stackable for easy storage

**1377081** \$176<sup>99</sup> DZN ★



### CURL UP STRIPS

- Durable rubber non-skid strips are used by placing them under the knees when performing the curl up assessment
- The starting position is with the fingertips on one edge of the strip
- The width of the measuring strip determines how far the student needs to curl up
- Available in two widths depending on the age of the students

**1377661** 3"W (5-9 Year Olds) \$7<sup>99</sup> EA  
**1377662** 4 1/2"W (Ages 10 and Up) \$7<sup>99</sup> EA

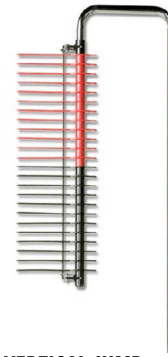

### VERTICAL JUMP CHALLENGER

- Telescopes from 4 to 12 feet
- Heavy duty base and casters for stability and portability
- Moveable metal arms placed at 1" increments
- Highest arm reached during jump reading is measured
- Includes handy reset pole
- Weight plates not included

**1245448** \$550<sup>99</sup> EA



### PUSH UP TRAINING MAT

- Colorful, poly-vinyl mat teaches the proper push up technique
- The attached foam piece assures the child is safely executing the push up
- Instructions are embossed right on the mat

**1267167** \$47<sup>99</sup> EA



### CURL-UP MAT

- Screened on lined mat ensures that students do curl-ups properly
- One end is for 3" and the other end for 4 1/2" for testing all ages
- Lightweight, soft, foam mat rolls up for easy storage

**1388274** 48"L x 24"W x 5/16" \$35<sup>99</sup> EA ★

### CARPETED LONG JUMP MAT

- Carpet on top and non-slip bottom
- Measures long jump distance
- Measures up to 10' in 2" increments

**1268928** Carpet size - 12'L x 30"W \$113<sup>99</sup> EA ★

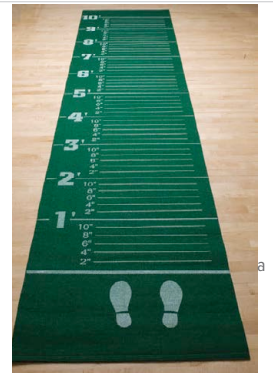

## BASELINE

### BASELINE FLEX TESTER

- Scales printed in inches and centimeters
- For use with any fitness program measuring flexibility
- Sturdy construction with built-in footplate and maximum stretch indicator that remains in place until reset
- Deluxe edition offers extra features such as enabling test protocols to vary the scale starting point and an adjustable reach indicator allowing for variations
- Assembly is required

**1375499** Standard \$178<sup>99</sup> EA  
**1375500** Deluxe \$262<sup>99</sup> EA



### FLEXIBILITY ASSESSMENT TESTER

- Durable, powder coated steel construction with non-skid, non marring base
- For use with Fitnessgram®, SHAPE, Cooper Institute and YMCA programs
- Foot plates fold flat for easy storage and transport
- Smooth glide reach indicators with easy to read English and Metric calibration
- Assembly required

**1378689** Single - 26"L x 15"W x 12.5"H \$125<sup>99</sup> EA ★  
**1378691** Double - 38"L x 15"W x 12.5"H \$193<sup>99</sup> EA ★





- Perfect for basketball courts, gymnastics areas, wrestling facilities, rehab centers and more
- Installs easily and the brightly colored pads will enhance the appearance of your facility
- Made of 7/16" thick wood backing, 18 oz. vinyl, and have a 1" lip at the top and bottom for attachment to the wall
- We recommend our Aluminum Channeling for mounting your wall pads, but they can be bolted in place - hardware not included
- Covered material meets California Fire Marshall's specifications for flammability

### WALL PADS WITH GRAPHICS

1 3/8" Crosslink Polyethylene

20028347	2' x 5' x 13/8"	\$339 <sup>99</sup> EA	
20028353	2' x 6' x 13/8"	\$424 <sup>99</sup> EA	
20028360	2' x 7' x 13/8"	\$382 <sup>99</sup> EA	

2" High Density Polyurethane

20028351	2' x 5' x 2"	\$335 <sup>99</sup> EA	
20028358	2' x 6' x 2"	\$339 <sup>99</sup> EA	
20028364	2' x 7' x 2"	\$376 <sup>99</sup> EA	

2 1/2" Combination Wall Pads

20028349	2' x 5' x 2 1/2"	\$353 <sup>99</sup> EA	
20028355	2' x 6' x 2 1/2"	\$364 <sup>99</sup> EA	
20028362	2' x 7' x 2 1/2"	\$417 <sup>99</sup> EA	

### WALL PADS WITHOUT GRAPHICS\*

1 3/8" Crosslink Polyethylene

20028348	2' x 5' x 13/8"	\$286 <sup>99</sup> EA	
20028354	2' x 6' x 13/8"	\$346 <sup>99</sup> EA	
20028361	2' x 7' x 13/8"	\$312 <sup>99</sup> EA	

2" High Density Polyurethane

20028352	2' x 5' x 2"	\$285 <sup>99</sup> EA	
20028359	2' x 6' x 2"	\$289 <sup>99</sup> EA	
20028365	2' x 7' x 2"	\$312 <sup>99</sup> EA	

2 1/2" Combination Wall Pads

20028350	2' x 5' x 2 1/2"	\$285 <sup>99</sup> EA	
20028356	2' x 6' x 2 1/2"	\$323 <sup>99</sup> EA	
20028363	2' x 7' x 2 1/2"	\$283 <sup>99</sup> EA	

**COLOR CHOICES:** Choose from 14 school colors, in solids or alternating panel colors.  
Due to dye lots and natural variations, vinyl colors may vary slightly if ordered at separate times.

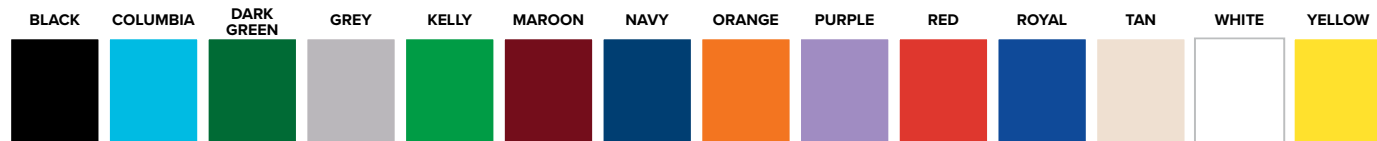

### ALUMINUM CHANNELING FOR WALL PADS

- Fastest and easiest method for attaching wall padding to your walls
- Pads fit into the channeling securely and lock-in at the top for a smooth, neat appearance (no ugly bolts or screws to cover up)
- Worn or damaged pads can be easily removed and replaced one panel at a time by simply removing the top channel
- Includes top and bottom channels
- Sold in 6' lengths



6870YXXXDS 6" Aluminum Channeling \$71<sup>99</sup> SET

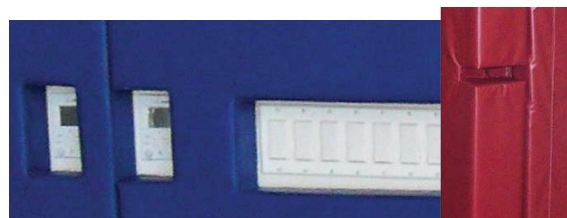

**CUT OUT FOR WALL PADS AND I-BEAM PADS**

### WALL PAD ACCESSORIES

20028346	Cut Out	\$139 <sup>99</sup> SET	
20028345	Corner Pad	Call for Pricing	





### FLAME RETARDANT WALL PADS

- Class A pads are constructed of 7/16" OSB Board, with 2" highly flame resistant polymerized open cell foam and covered with 16 oz. FR rated vinyl
- Pads have a 1" lip top and bottom for attachment to the wall
- Corner round molding or aluminum channel (**not included**) may be used to cover bolt heads after installation (**installation hardware is not included**)
- Pads comply with the standards set forth by ASTM E84
- Meets NFPA 255, UL 723, ANSI 2.5 and UBC 8-1 (42-1)
- Available colors: Black, Columbia Blue, Dark Green, Grey, Kelly Green, Maroon, Navy Blue, Orange, Purple, Red, Royal Blue, Tan, White and Yellow

**CERTIFICATE OF COMPLIANCE**



#### With Graphics

1248029	2' x 5' x 2"	\$513 <sup>99</sup> EA	
1248036	2' x 6' x 2"	\$577 <sup>99</sup> EA	
1248043	2' x 7' x 2"	\$610 <sup>99</sup> EA	

#### Without Graphics

1247992	2' x 5' x 2"	\$325 <sup>99</sup> EA	
1248005	2' x 6' x 2"	\$431 <sup>99</sup> EA	
1248015	2' x 7' x 2"	\$474 <sup>99</sup> EA	



### I-BEAM PADS

- Designed to minimize the risk for injury from contact with a steel support I-beam
- Crafted to provide maximum protection, durability and ease of installation
- Pads are 6' H, covered with 18 oz. vinyl and filled with 4" high density polyfoam
- Fits beams up to 8" wide
- Available in Black, Columbia Blue, Dark Green, Grey, Kelly Green, Maroon, Navy Blue, Orange, Purple, Red, Royal Blue, Tan, White or Yellow
- Please specify color

G862YXXDS \$469<sup>99</sup> EA



### COLUMN PADS

- Provide protection against collisions with support posts and poles
- Easily installed and enhances the appearance of your facility
- Available for both free-standing and in-wall supports

Call for more information and pricing on our column pads.



MADE IN 8" WIDE SECTIONS

### STAGE PADS

- If your gymnasium is also used as an auditorium or theater, you need our stage pads to reduce the chance of injury
- Custom made to your specific application
- The inboard side of the fold is beveled so the edge of the stage is fully padded
- Fastener strips are included to prevent the pad from shifting, sliding or detaching while in use
- Manufactured using 1 3/8" crosslink polyethylene foam covered in 18 oz. vinyl
- Available in Black, Columbia Blue, Dark Green, Grey, Kelly Green, Maroon, Navy Blue, Orange, Purple, Red, Royal Blue, Tan, White or Yellow
- Please specify color

**COLOR CHOICES: Choose from 14 school colors, in solids or alternating panel colors.**

Due to dye lots and natural variations, vinyl colors may vary slightly if ordered at separate times.



**CALL FOR MORE INFO & PRICING**

## DELUXE GYM FLOOR COVERS

### BUILT TOUGH TO PROTECT YOUR INVESTMENT!

- Ultra-durable 3-ply fabrics
- Reinforced polyester mesh yarns coated with PVC on both sides
- Seams are engineered to be as strong as the fabric itself (Meets Military and Dept. of Defense requirements)
- Use either side – will lay smooth and flat
- Fabric is anti-bacterial, anti-fungal and rot and mildew resistant
- Meets stringent flame retardant standards including California Fire Marshall, NFPA 701 and UL 300
- Order in 10' wide sections adding 6" – 12" for overlapping
- Example: For a 75' x 110' floor, order 8 sections 10' x 110'

1369726	18 oz., 8 Yr. Warranty	\$1 <sup>25</sup> SQ.FT
1048315	22oz., 10 Yr Warranty	\$1 <sup>99</sup> SQ.FT
1083743	27 oz., 15 Yr Warranty	\$1 <sup>79</sup> SQ.FT
1270433	32 oz., 17 Yr Warranty	\$2 <sup>09</sup> SQ.FT

### 18 OZ. COLOR OPTIONS:

**Black, Burgundy, Green, Kelly Green, Light Gray, Navy Blue, Orange, Red, Royal Blue, Tan, Yellow**

### 22 OZ. COLOR OPTIONS:

**Black, Brown/Tan, Burgundy, Green, Light Gray, Navy Blue, Red, Royal Blue, Tan, Tan/Royal Blue, Yellow**

### 27 & 32 OZ. COLOR OPTIONS:

**Black, Brown/Tan, Burgundy, Dark Gray, Green, Navy Blue, Red, Royal Blue, Tan, Tan/Royal Blue**



Actual colors may vary.

**\*ADA COMPLIANT. COLORS MAY VARY.**

## SAVE BY PURCHASING PRE-CUT COVERS!



\*ADA COMPLIANT.

### PRE-CUT GYM FLOOR COVERS

- Durable, vinyl cover protects your gym floor during non-athletic events
  - Covers are already cut to 10'W x 100'L sections
- Color Options: **Royal Blue, Tan.**

1369718	18 oz., 8 Yr. Warranty	\$1,599 <sup>99</sup> EA	
1162677	22 oz., 10 Yr. Warranty	\$1,949 <sup>99</sup> EA	
1375308	27 oz., 15 Yr Warranty	\$2,199 <sup>99</sup> EA	
1375310	32 oz., 17 Yr Warranty	\$2,299 <sup>99</sup> EA	

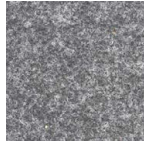

**GREY**



**BLUE**

### PRO SHIELD GYM FLOOR COVER TILE

- Beautiful acoustic carpet tiles for all kinds of events
- No need for tape, tiles will lie flat and won't slide
- 100% solution-dyed polypropylene top surface and a non-staining polyolefin backing
- Lightweight for quick set up and breakdown
- Approximately 39 3/8" x 78 3/4" (22 lbs. per tile)

#### 3 Year Limited Warranty

Color Options: **Blue, Grey.**

1384778	Specify Color	\$69 <sup>99</sup> EA	
---------	---------------	-----------------------	--

### PRO SHIELD GYM FLOOR TILE CART

- Stores and transports your gym floor cover tiles
- Steel frame with a carpeted plywood platform
- Features 5" casters and removable 29" handle
- 950 lb. capacity (70-80 tiles)

#### 3 Year Limited Warranty

1384780	80"L x 43"W	\$999 <sup>99</sup> EA	
---------	-------------	------------------------	--

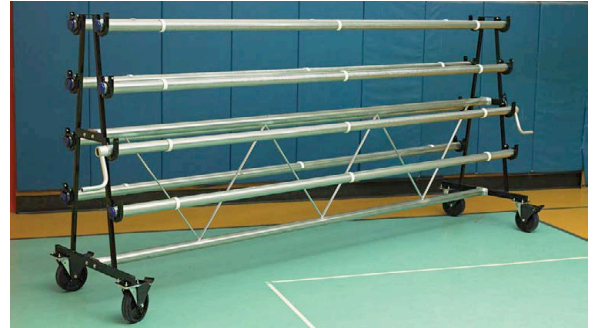

### GYM FLOOR COVER MOBILE STORAGE RACKS

- Use with 10' wide sections only
- All steel rack with Delrin roller bearings
- Supports up to 2800 lbs.
- Four 8" diameter non-marring wheels for easy rolling (2 with locks)
- Includes 2 hand cranks for winding, 3 fabric clips per roller, and instructions
- 2 1/2" diam., 14 gauge steel rollers with locks to prevent accidental unwinding
- 67"H x 34"W x 12'6"L

#### 6 Year Limited Warranty

1048407	6 Roller Model	\$3,999 <sup>99</sup> EA	
1048414	8 Roller Model	\$5,297 <sup>99</sup> EA	
1048421	10 Roller Model	\$4,866 <sup>99</sup> EA	



### FLOOR COVER TAPE DISPENSERS

- For floor cover tape up to 3" wide

1. 1270419	Hand Held	\$61 <sup>99</sup> EA
2. 1270426	Upright Walk Behind	\$449 <sup>99</sup> EA

### FLOOR COVER TAPE

- Secures overlaps and edges without leaving residue on floor or cover
- Purchase two cases of tape and receive a "FREE" walk behind tape dispenser (1 per customer)

3. 1270587	16 Rolls - 3" X 36 yds	\$229 <sup>99</sup> CASE
------------	------------------------	--------------------------



### RACK BRUSH ASSEMBLY

- Bolts to the rack to remove debris from your floor cover as you roll it up

1248647	\$1,262 <sup>99</sup> EA
---------	--------------------------



### ELECTRIC POWER WINDER

- Quickly and easily winds up each gym floor cover section

1048438	\$1,999 <sup>99</sup> EA	
---------	--------------------------	--



## BONDED-FOAM MATS

**Firmer Than Polyfoam Mats, But Softer Than Polyethylene Mats!**

- Perfect for tumbling, exercise, play and low impact gymnastics by elementary and middle school age children
- Top quality 2" thick bonded foam mat designed for comfort and moderate support
- Nylon reinforced tough 18 oz. vinyl cover uses double reinforced, nylon stitched inverted seams to create a smooth working surface
- Mats have 2' panels and folds

4' X 8' MAT SHOWN  
Specify Color(s) when ordering!

### BONDED-FOAMMATS

MAT SIZE	HOOK & LOOP FASTENER OPTIONS								
	NONE			ENDS ONLY			ALL SIDES		
	ITEM #	ROYAL	CUSTOM	ITEM #	ROYAL	CUSTOM	ITEM #	ROYAL	CUSTOM
4' x 8'	1280807	\$442 <sup>99</sup> ★	\$462 <sup>99</sup> ★	1041903	\$575 <sup>99</sup> ★	\$595 <sup>99</sup> ★	1041484	\$584 <sup>99</sup> ★	\$604 <sup>99</sup> ★
5' x 10'	1280814	\$624 <sup>99</sup> ★	\$644 <sup>99</sup> ★	1041927	\$821 <sup>99</sup> ★	\$841 <sup>99</sup> ★	1041507	\$869 <sup>99</sup> ★	\$889 <sup>99</sup> ★
6' x 12'	1280821	\$1,042 <sup>99</sup> ★	\$1,062 <sup>99</sup> ★	1041941	\$1,134 <sup>99</sup> ★	\$1,154 <sup>99</sup> ★	1041521	\$1,209 <sup>99</sup> ★	\$1,229 <sup>99</sup> ★



## ULTIMAT<sup>®</sup>

**Our Firmest and Lightest Mat!**

- Provides firm support for high impact activities
- Use in physical education and gymnastic classes, cheerleading and martial arts training and more
- 1 3/8" firm cross-linked foam covered in tough 18 oz. vinyl
- Cover resists abrasions, tears, fungus and mildew
- Mats have 2' panels and folds

### WALL MOLDING STRIPS

- Attach permanently to wall for hanging mats with fasteners on 4 sides
- 1 5/8" wide hook and loop fastener strip holds mats to wall
- Sold in 6' sections

1044782DS Specify Hook or Loop Fasteners \$65<sup>99</sup> SET

### ULTIMAT

MAT SIZE	HOOK & LOOP FASTENER OPTIONS								
	NONE			ENDS ONLY			ALL SIDES		
	ITEM #	ROYAL	CUSTOM	ITEM #	ROYAL	CUSTOM	ITEM #	ROYAL	CUSTOM
4' x 6'	1280838	\$267 <sup>99</sup> ★	\$287 <sup>99</sup> ★	1257915	\$298 <sup>99</sup> ★	\$318 <sup>99</sup> ★	1257922	\$273 <sup>99</sup> ★	\$293 <sup>99</sup> ★
4' x 8'	1280845	\$333 <sup>99</sup> ★	\$353 <sup>99</sup> ★	1041880	\$388 <sup>99</sup> ★	\$408 <sup>99</sup> ★	1041545	\$384 <sup>99</sup> ★	\$404 <sup>99</sup> ★
5' x 10'	1280852	\$499 <sup>99</sup> ★	\$519 <sup>99</sup> ★	1041965	\$551 <sup>99</sup> ★	\$571 <sup>99</sup> ★	1041569	\$538 <sup>99</sup> ★	\$558 <sup>99</sup> ★
6' x 12'	1280869	\$639 <sup>99</sup> ★	\$659 <sup>99</sup> ★	1041989	\$639 <sup>99</sup> ★	\$659 <sup>99</sup> ★	1041583	\$671 <sup>99</sup> ★	\$691 <sup>99</sup> ★

**COLOR CHOICES:** Choose from 14 school colors, in solids or alternating panel colors.  
Due to dye lots and natural variations, vinyl colors may vary slightly if ordered at separate times.



## EXPANDO NOVA DUO LAYERED-FOAM MATS

Combines the Soft Cushion of Polyfoam with the Firm "no bottoming" Trait of Polyethylene!

- Perfect for young, beginner or intermediate tumblers
- A 1" layer of polyfoam provides the softness for younger, lightweight children, while a firmer 1 3/8" polyethylene layer keeps the mat from "bottoming out" during more extensive use
- Nylon reinforced tough 18 oz. vinyl cover uses double reinforced, nylon stitched inverted seams to create a smooth working surface
- Mats have 2' panels and folds and are lightweight for easy handling and storage
- **Fasteners on ends only**



**1" POLYFOAM LAYER  
A FIRMER 1 3/8"  
POLYETHYLENE LAYER**

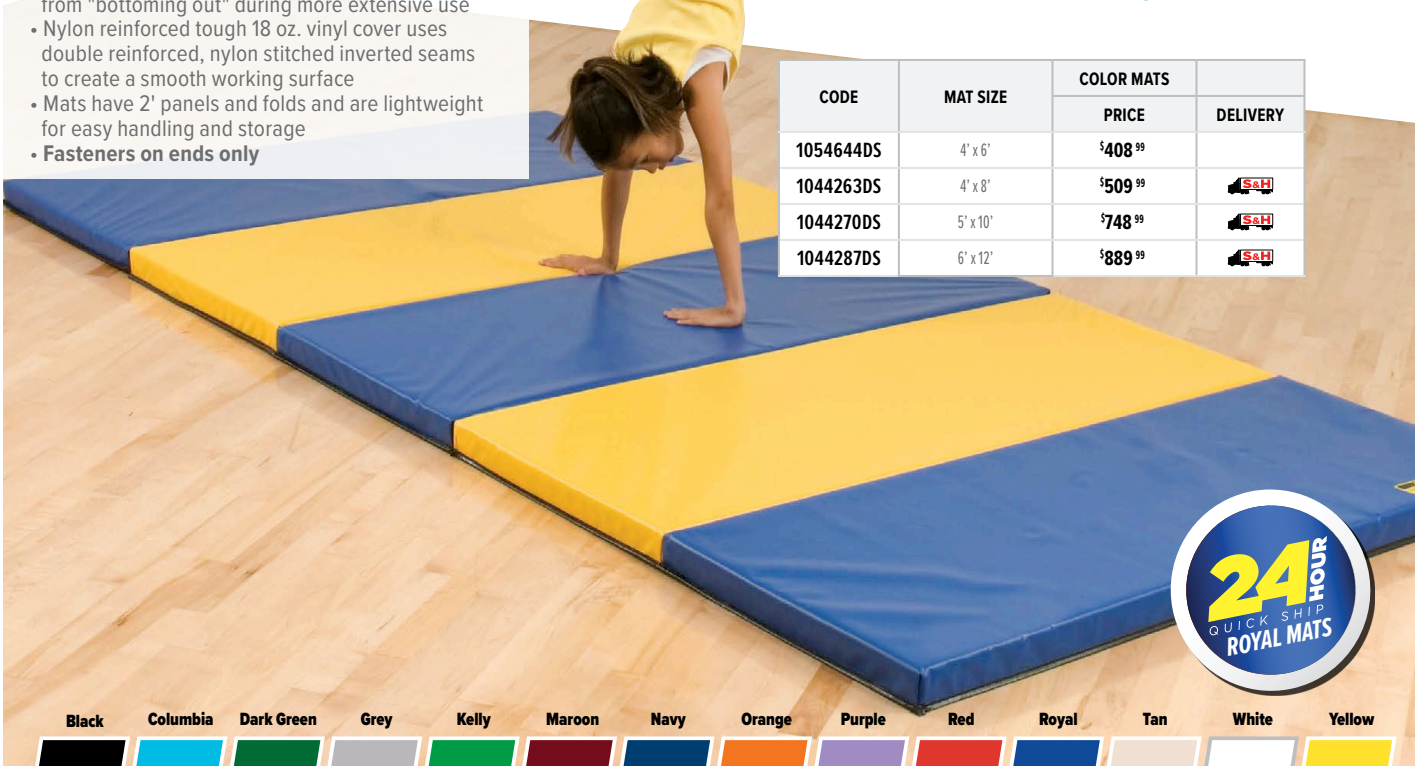

CODE	MAT SIZE	COLOR MATS	
		PRICE	DELIVERY
1054644DS	4' x 6'	\$408 <sup>99</sup>	
1044263DS	4' x 8'	\$509 <sup>99</sup>	
1044270DS	5' x 10'	\$748 <sup>99</sup>	
1044287DS	6' x 12'	\$889 <sup>99</sup>	



### MAT TAPE

- Easy to use and remove
- Will not stretch out
- Secures overlaps

6411XXXX	3" x 84'	\$21 <sup>99</sup>	ROLL ★
6406XXXX	4" x 84'	\$22 <sup>99</sup>	ROLL ★



### MAT CART

- A durable, PVC mat truck transports and stores mats of all sizes
- Lightweight cart is easily maneuvered by one person
- The convenient handle folds flat for easy storage
- Some assembly required

**1246155** 7"H x 22"W x 66"L \$403<sup>99</sup> EA



### MATT-KLEEN® ALL PURPOSE DISINFECTANT CLEANER

- Helps stop the spread of skin diseases and infections
- Ideal for wrestling and gymnastic mats, training tables and shower floors
- Highly concentrated; 2 oz. makes one full gallon

**1092479** Gallon \$99<sup>99</sup> EA



### Mueller® WHIZZER®

- Multipurpose concentrate kills HIV-1 (AIDS virus), MRSA, Hepatitis B & C, and other viruses. Kills strep, staph and fungus germs on contact.
- Cleaner, fungicide, mildewstat, virucide and deodorizer - all in one. Comes complete with 2 FREE Pint spray bottles.
- Economical. One ounce of concentrate mixed with water makes a gallon of full-strength disinfectant. 128 dilutions per gallon.
- Fast. Apply directly to mats, floors, walls, training tables, locker rooms, or personal items. Just wipe dry.

**30 Day Limited Warranty**

**MU230201** 1 Gallon + 2 FREE Pint Spray Bottles \$94<sup>99</sup> CASE

**COLOR CHOICES:** Choose from 14 school colors, in solids or alternating panel colors. Due to dye lots and natural variations, vinyl colors may vary slightly if ordered at separate times.





## EZ-FLEX CARPET ROLL

- Made from soft but durable 26 oz. needle punch carpet and lightweight crossed-link polyethylene sports foam
- Each roll includes the flexible rolling system for fast, easy set up and storage
- Indestructible flame-laminated bond between the carpet and the foam
- Includes one 4" roll of hook fastener per seam (orders of 2 or more rolls)
- A full floor consists of 7 rolls 6' x 42' which combine to create a 42' square surface

### 3 Year Limited Warranty

Color Options: **Black, Blue, Charcoal Grey, Grey, Purple, Red, Teal.**

1450124	6' x 42' x 13/8" Roll (Specify Color)	\$1,249 <sup>99</sup> EA	
1450132	6' x 42' x 2" Roll (Specify Color)	\$1,699 <sup>99</sup> EA	



## COLOR OPTIONS

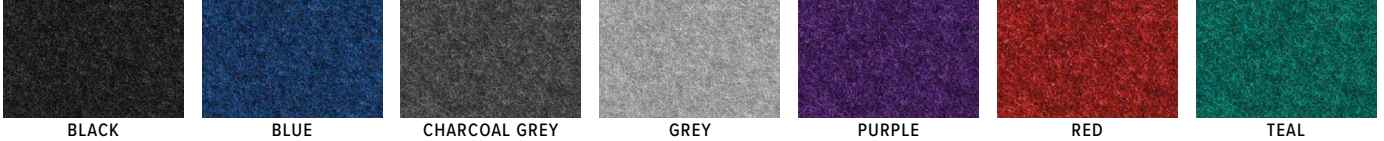

## EXPANDO SUPERNOVA MATS

### Our Softest Mat for Low Impact Activities With Very Young Users!

- For teaching basic gymnastics & exercises to children ages 3-9
- So light young children can move and store them
- Nylon reinforced tough 18 oz. vinyl cover uses double reinforced, nylon stitched inverted seams to create a smooth working surface
- Mats have 2' panels and folds
- **Fasteners on Ends Only**

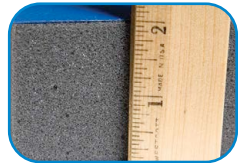

**2" 100 ILD POLYFOAM**



4' x 8' MAT SHOWN

CODE	SIZE	COLOR MATS	
		PRICE	DELIVERY
1044300DS	4' x 6'	\$353 <sup>99</sup>	
1044324DS	4' x 8'	\$405 <sup>99</sup>	
1044348DS	5' x 10'	\$614 <sup>99</sup>	

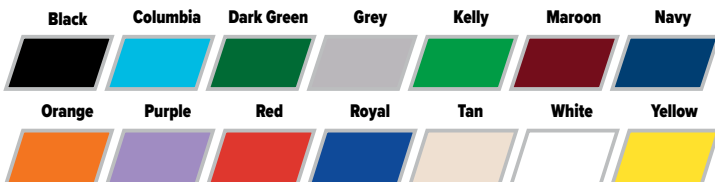

## SOFLAN LANDING MATS

- Provide additional cushion to build confidence
- Covered in 18 oz. coated vinyl, topped with nylon mesh breather fabric and filled with semi-firm polyfoam
- Strategically placed nylon web handles are securely attached
- Available colors: Black, Dark Green, Dark Purple, Grey, Kelly Green, Light Blue, Navy Blue, Orange, Red, Royal Blue, Tan, White and Yellow
- Please allow 6 weeks for delivery

### 8" Thick Landing Mats

G785YXXDS	5' x 10' Folding	\$1,409 <sup>99</sup> EA	
G786YXXDS	6' x 12' Folding	\$2,169 <sup>99</sup> EA	
G788YXXDS	8' x 12' Folding	\$2,732 <sup>99</sup> EA	
G904YXXDS	4' x 8' Non-Folding	\$837 <sup>99</sup> EA	
G905YXXDS	5' x 10' Non-Folding	\$1,259 <sup>99</sup> EA	
G906YXXDS	6' x 12' Non-Folding	\$2,117 <sup>99</sup> EA	

### 12" Thick Landing Mats

G935YXXDS	5' x 10' Folding	\$2,263 <sup>99</sup> EA	
G936YXXDS	6' x 12' Folding	\$2,887 <sup>99</sup> EA	

**GYM CHALK**

- For weight-lifting or gymnastics
- Conveniently wrapped in 2 oz. blocks
- Eight blocks per 1 lb. package

**PGE4360X**      \$28<sup>99</sup> LB ★

### HD INFLATOR

- 1/6 horsepower AC motor
- 80psi with pressure gauge
- Includes needle and tire valve
- Weight: 8 lbs.

**1240672** \$269<sup>99</sup> EA ★



### ECONOMY ELECTRIC INFLATOR

- High impact plastic desktop inflator
- 120v and .9 amps
- 100 psi gauge
- Coiled inflation tube that will stretch to 30"
- Comes with needle and other inflation valves

**MSECOLEY** \$129<sup>99</sup> EA ★



### STEEL HAND INFLATOR

- Compact, lightweight and portable
- Made of heavy duty steel to last through the years
- Needle included

**MSHNINFSY** \$9<sup>99</sup> EA ★



### HEAVY DUTY UPRIGHT PUMP

- 21" reinforced hose
- In-line gauge provides correct pressure for all types of balls
- Needles sold separately

**1069273** \$23<sup>99</sup> EA ★



### INFLATING NEEDLES

- MSNEDPAC6** Needle Pack \$5<sup>99</sup> PACK OF 6 ★
- MSNED100** Pack of 100 \$35<sup>99</sup> PACK OF 100 ★
- 1369558** Digital Pressure Gauge \$32<sup>99</sup> EA ★



### DOUBLE ACTION HAND PUMP

- Compact, lightweight and portable
- Pump twice the volume of air with dual action
- Needle included

**1369557** \$11<sup>99</sup> EA ★

### AIRMAN® CORDLESS

- Simple one handed, push button operation
- Will inflate anything from balls to bicycle tires
- 9.6v rechargeable nicad battery
- 120 psi gauge
- Includes AC power cord and charger and 12v DC cord

**22006XXX** \$119<sup>99</sup> EA



### SKYSCAN™ TI-PLUS HEAT INDEX WARNING SYSTEM

- Easy to read arrow display showing all ranges of dangerous heat conditions
- Audible warning sounds before heat index reaches critical levels
- Accurate display temperature, relative humidity and heat index
- Critical info is stored in memory for 24 hrs. and can be re-displayed
- Also functions as a countdown timer, stopwatch and alarm

**1150216** \$169<sup>99</sup> EA



### STRIKE ALERT HD LIGHTNING DETECTOR

- Intuitive Graphical display
- Shows lightning strike distance up to 40 miles away
- Displays 1-hour storm trend and intensity
- Tells you how long lightning has stopped so play can resume
- Offers 360 degree storm tracking in all directions
- Audible and vibrating warnings
- Low power consumption using two AA batteries

**1384282** \$309<sup>99</sup> EA



### SKYSCAN™ P5 LIGHTNING DETECTOR

- Detects lightning as far as 40 miles away and accurately ranges its approach by both an audible tone and by four LED's which are ranged in miles (0-3, 3-8, 8-20, 20-40)
- Requires (2) 9V batteries (not included)
- AC adapter not included
- Rugged weather resistant case

**SKYSCANX** Portable Unit \$327<sup>99</sup> EA  
**20026502** 110v AC Adapter \$49<sup>99</sup> EA





### EPIK

- The Fox 40 Classic Epik has the authentic Classis sound in a sleek design and integrated co-molded Cushioned Mouth Grip (CMG)
- No moving parts to freeze, jam or deteriorate
- Chambers are designed to self-clear when submerged in water
- Assortment includes: 2 black, 2 red, 2 orange, 2 yellow, 1 pink, 1 blue, 1 green, and 1 white

1458128 Assorted Colors with Lanyard \$74<sup>99</sup> DZN



NEW!



### LAUNDRY LOOPS

- The fastest and most effective way to wash laundry in the team environment
- Each player loops clothes prior to washing
- Each item is washed and dried while attached to loop
- Built in sock loop and name tag

Color Options: Black, Royal, Scarlet, White.

1459428 Pack of 25, Specify Color \$69<sup>99</sup> PACK

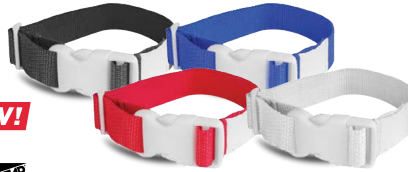

COACH'S CHOICE



### LOCKER ROOM TOWELS (12-PACK)

- 100% cotton terry cloth

MSTOWELS 22"W x 44"L \$54<sup>99</sup> DZN ★



### ELECTRONIC WHISTLE

- 4-switch, three tone functions-  
Off/Tone 1/Tone 2/Tone 3
- Sound can be aimed in specific directions
- Includes detachable wrist lanyard and 9-volt battery
- Instead of being mouth-operated, the Fox 40 electronic whistle, utilizes a push button feature for multiple operators to use

1459013 \$28<sup>99</sup> EA



### PORTABLE SIGNAL HORN

- Offers a loud sound with a long lasting 8 oz. canister
- Push-button style, high-impact construction
- CANNOT BE SHIPPED BY AIR

MSAIR8ZH \$32<sup>99</sup> EA  
MSAIR8ZR 8 oz. Refill \$21<sup>99</sup> EA

### CLASSIC

- Revolutionary design allows for 3 aerodynamic wind chambers to deliver a sharp, clear tone with less effort
- No cork ball to stick or deteriorate
- Unaffected by moisture
- Extremely loud, recommended for official use only

MSWHIFOX 1240368

Fox 40 Classic \$9<sup>99</sup> EA  
With Mouth Grip \$9<sup>99</sup> EA



### LANYARDS

- 100% nylon lanyard with clamp and swivel
  - Must order 12 per color
  - Whistles not included
- Color Options: Gold, Kelly, Royal, Scarlet, White, Black, Maroon, Color My Class.

MSLNYD Select Color \$14<sup>99</sup> DZN ★  
1392970 Color My Class \$14<sup>99</sup> DZN ★

### LAUNDRY BAGS

- White nylon mesh bag with drawstring

MSLB1824 18" x 24" \$10<sup>99</sup> EA ★  
MSLB2436 24" x 36" \$13<sup>99</sup> EA ★



### DELUXE LAUNDRY BAG

- Heavy duty 100% polyester mesh
  - Cotton ID flag for player name or number marking
  - Rubber closure attached
- Color Options: Black, Gold, Royal, Scarlet, White.

1197327 Laundry Bag - 18" x 24" \$12<sup>99</sup> EA ★  
1240214 Red Rubber Closure \$4<sup>99</sup> EA ★



### MINI MEGAPHONE

- 300 yard range - 8 watts of power
- Trigger controlled; adjustable volume control; siren button
- High impact plastic with carrying strap
- Built-in microphone
- Operates on (6) AA batteries (not included)

MSMEG22W \$109<sup>99</sup> EA ★



### LONG RANGE MEGAPHONES

- 1000 yard range - 25 watts of power
- Adjustable volume control
- Siren button
- High impact PVC construction
- Operates on (8) C batteries (not included)
- Weight: 7 lbs.

MSMEG61W Hand Held Mic \$229<sup>99</sup> EA ★  
MSMEG51W Built-in Trigger Mic \$174<sup>99</sup> EA ★





WIRELESS CONTROLLER



OPTIONAL STAND  
(SOLD SEPARATELY)

# MacGregor

## 4' X 2' MULTISPORT INDOOR SCOREBOARD

- 6" LED numerals with 3 digit scoring, digital periods, bonus and possession indicators, (fouls can be kept on controller) last minute counts down in 1/10th seconds
- Durable plastic cabinet with plexiglass face
- Scores basketball, volleyball, wrestling and can function as a stopwatch or clock
- Includes rechargeable wireless remote control with 300' range and 12 frequency settings to help eliminate wireless interference
- Controller changes sports easily and can turn scoreboard on and off remotely
- Built in wall mount slots or use with portable stand (sold separately)
- Includes 100' of data cable if cable connection is preferred
- Weight: 24 lbs.
- Assembled stand measures 60"H x 56"W x 31"D

**\$1,599<sup>99</sup>**

**SK3048** ★ Complete Unit

OPTIONS		
<b>1317107</b>	Optional Stand	<b>\$199<sup>99</sup></b> EA ★
<b>1375095</b>	Replacement Remote	<b>\$399<sup>99</sup></b> EA ★



## MacGregor

### COUNT UP/DOWN CLOCK

- 4" LED numbers
- Timer counts up or down to 99:59
- 120 a/c power with 8 hour rechargeable battery
- Perfect device designed for any timed activities in your P.E. or Athletic program
- Built in control on top of timer with horn

<b>1126631</b>	6"H x 13"W x 4"D	<b>\$429<sup>99</sup></b> EA ★
<b>1139730</b>	Replacement Battery	<b>\$69<sup>99</sup></b> EA ★



### LED BASKETBALL POSSESSION INDICATOR

- Bright, 10,000 hour LED lights
- Toggle switch operation
- Includes 15' cord for AC operation
- Built in rechargeable battery with 4 - 6 hour battery life
- Weight: 5 lbs.

<b>1162639</b>	5"H x 20"W x 2"D	<b>\$199<sup>99</sup></b> EA ★
----------------	------------------	--------------------------------



### BUDGET POSSESSION INDICATOR

- Rigid plastic triangular design with arrow
- Simply turn to indicate possession
- Weight: 1 lb.

<b>K30607</b>		<b>\$39<sup>99</sup></b> EA ★
---------------	--	-------------------------------



### PORTABLE MANUAL SCOREKEEPER

- 6" score digits
- 2.5" Period/Games digit up to 5
- Scores game up to 99 for each side
- No assembly required
- Lays flat for storage

<b>1196177</b>	11"H x 23"W	<b>\$79<sup>99</sup></b> EA ★
----------------	-------------	-------------------------------



### MANUAL TABLETOP DOUBLE SIDED SCOREBOARD

- 6" numbers for scoring
- 2.5" numbers to score games (0-5 for each side)
- Scores up to 30 for each team
- Double-sided, see the score from front and back
- Folds up for easy transport and storage

<b>MSMLTSCR</b>	7"H x 15"W	<b>\$79<sup>99</sup></b> EA ★
-----------------	------------	-------------------------------

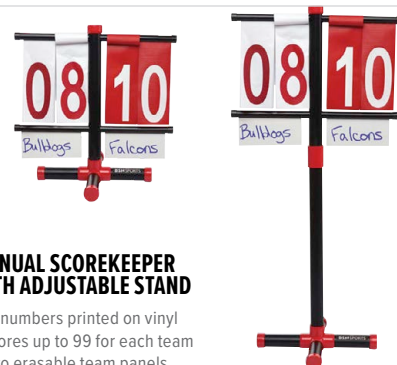

### MANUAL SCOREKEEPER WITH ADJUSTABLE STAND

- 7" numbers printed on vinyl
- Scores up to 99 for each team
- Two erasable team panels
- PVC stand measures 38"H with a 15" x 15" base
- Converts from floor model to 12"H table top unit

<b>1162448</b>		<b>\$99<sup>99</sup></b> EA ★
----------------	--	-------------------------------

## INDOOR TABLETOP SCOREBOARD



- Dimensions: 16"H x 24"W x 10"D - 13 lbs.
- LED clock digits: 4.75", LED score digits: 4.25"
- Scores basketball, volleyball and wrestling and can function as a metronome, stopwatch, clock with alarm and program timer
- Included wireless remote (100' range) allows operator to change score and start/stop the clock
- 4 user-programmable frequency settings for operating multiple units independently in the same area
- Includes digital periods, bonus, team fouls and possession indicators
- Indoor use only
- Optional assembled stand measures 43"H x 28"W x 28"D

**SK2229R** Indoor Tabletop Scoreboard \$599<sup>99</sup> EA ★



**BUILT IN CONTROL PANEL**

### OPTIONS

<b>1293784</b>	Wheeled Stand	\$135 <sup>99</sup> EA ★
<b>1240597</b>	Extra Loud Horn	\$74 <sup>99</sup> EA ★
<b>1142266</b>	Carry Bag	\$90 <sup>99</sup> EA ★
<b>1201789</b>	Replacement Remote	\$61 <sup>99</sup> EA ★
<b>1167443</b>	Replacement Power Cord/Adaptor	\$29 <sup>99</sup> EA ★



**BUILT IN CONTROL PANEL**

## INDOOR/OUTDOOR TABLETOP SCOREBOARD

Same as our popular SK2229R tabletop scoreboard with the following added features:

- Dimensions: 16"H x 24"W x 10"D - 24 lbs.
- Dual LED setting for indoor and outdoor brightness
- AC/DC, with built-in rechargeable battery (up to 6 hour battery life depending on brightness setting)
- Portable use only (do not store outside or use during inclement weather)
- Assembled stand measures 43"H x 28"W x 28"D

**1240580** Tabletop Scoreboard \$849<sup>99</sup> EA ★

### OPTIONS

<b>1293784</b>	Wheeled Stand	\$135 <sup>99</sup> EA ★
<b>1240597</b>	Extra Loud Horn	\$74 <sup>99</sup> EA ★
<b>1142266</b>	Carry Bag	\$90 <sup>99</sup> EA ★
<b>1201789</b>	Replacement Remote	\$61 <sup>99</sup> EA ★
<b>1167443</b>	Replacement Power Cord/Adaptor	\$29 <sup>99</sup> EA ★
<b>1171570</b>	Replacement Battery	\$64 <sup>99</sup> EA ★



## SEGMENT TIMER W/WIRELESS REMOTE

- 8" and 13" super-bright, LED numerals (300' viewing distance)
- Program your practice schedule and workout drills
- All steel cabinet with built in handle, weather protector, fence attachment and storage pouch for remote programmer
- AC or DC with built-in, 8 hour rechargeable battery
- 140 decibel horn sounds after each segment, 3 short beeps after each rest period
- Program up to 99 segments from 1 second to 99 minutes. The last minute always counts down in seconds
- Wireless remote remembers last entry and has a range of 65 feet
- Not water proof - do not leave outside when not in use
- Weight: 26 lbs.

<b>1239645</b>	Segment Timer	\$2,399 <sup>99</sup> EA ★
<b>1239652</b>	Replacement Wireless Remote	\$109 <sup>99</sup> EA ★
<b>1171570</b>	Replacement Battery	\$64 <sup>99</sup> EA ★

## WIRELESS SHOTCLOCKS & CONTROLLER

Module included for use with the SK2229R or SK999 scoreboards.

- Dimensions: 20"H x 15"W x 7"D - 12 lbs. ea
- 8" LED shot clock digits (300' viewing distance) 4.7" game clock digits
- Power supplied by built-in rechargeable batteries or 110v AC power cord
- Built in horns
- Assembled stand measures 48"H x 16"W x 26"D
- Intended for indoor use only
- Optional stand not included

**1171525** \$1,199<sup>99</sup> SET ★

### OPTIONS

<b>1171556</b>	Optional Stand	\$159 <sup>99</sup> EA ★
<b>1167443</b>	Replacement Power Cord/Adaptor	\$29 <sup>99</sup> EA ★
<b>1171570</b>	Replacement Battery	\$64 <sup>99</sup> EA ★

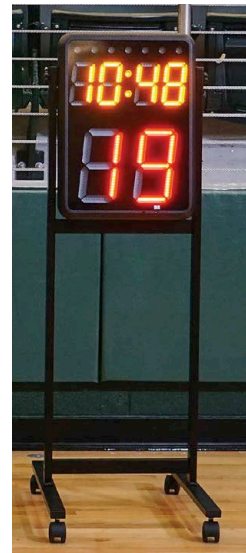
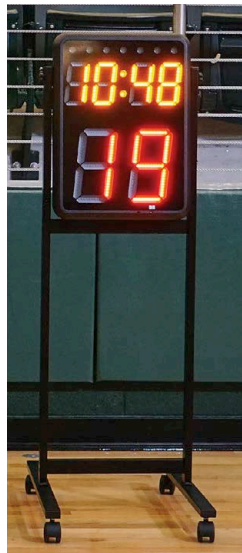

**WIRELESS REMOTE**



### MONSTER BALL CART

- Fabricated from 1" square steel
- Black powder coated finish
- Holds 15 official size basketballs

1 Year Limited Warranty

**1162608** 30"H x 49"W x 20"D - 30 lbs. \$349<sup>99</sup> EA ★



### DOUBLE MONSTER BALL CART

- Fabricated from 1" square steel
- Black powder coated finish
- Holds 30 official size basketballs

1 Year Limited Warranty

**1162615** 30"H x 49"W x 24"D - 54 lbs. \$549<sup>99</sup> EA ★



### DOUBLE-WIDE BALL CART

- Made of 1" rugged chrome steel
- Holds 30 full size basketballs
- Comes with heavy duty swiveled rubber casters

**1237634** 33"H x 45"W x 24"D - 35 lbs. \$394<sup>99</sup> EA ★



**3-ROW  
12 BALLS**



**4-ROW  
16 BALLS**



### HEAVY-DUTY BALL CARTS

- Welded 1" square wall tubing with 3/4" steel chrome plated, ball support arms
- Non-marring, high quality 360° swivel casters
- Extra wide wheel base avoids tipping
- Add a school or mascot name, up to (10) letters, to the end panels (lettering sold separately and is not applied by manufacturer)

5 Year Limited Warranty

Color Options: Grey, Royal Blue, Scarlet, White.

**1048452** 12 Ball Cart \$546<sup>99</sup> EA  
**1048490** 18 Ball Cart \$606<sup>99</sup> EA  
**1245899** Lettering \$116<sup>99</sup> EA



### 15 BALL CART

- Heavy duty chrome steel rods
- Solid triangular frames for strength and stability
- Non-marring casters
- Wide base design prevents tip over
- Holds 15 official size basketballs

**1159639** 38"H x 51"W x 19"D - 10 lbs. \$159<sup>99</sup> EA ★



### WIDE BODY BALL CARTS

- Heavy duty white powder coated steel tubing
- Non-marring, hard rubber casters with a wide, no-topple base
- Designed for easy storage and removal of balls
- 12 Ball Cart - 40"W x 40"H x 16"D
- 16 Ball Cart - 40"W x 52"H x 16"D

**BCART12W** 3 Row, 12 Balls \$104<sup>99</sup> EA ★  
**BCART16W** 4 Row, 16 Balls \$119<sup>99</sup> EA ★

### WALL MOUNT BALL RACK

- Black powder coated 1" steel tubing construction
- Easy to install with 4 screws (not included)
- Will hold up to 18 balls on 3 levels

**1197739** 40"H x 60"W x 15"D - 18 lbs. \$195<sup>99</sup> EA ★





### DOUBLE-SIDED BALL LOCKER

- Heavy duty 1" powder coated steel outside frame
- 5mm PVC coated steel mesh
- Allows for divided storage of balls
- Each side can be locked (locks not included)
- Holds up to 30 basketballs or volleyballs
- 8" back wheels allow for easy movement
- Fits through a standard doorway

**1237627** 44"H x 63"W x 24"D - 60 lbs. **\$459<sup>99</sup>** EA ★ 



### E-Z FOLD CART

- Aluminum square frame
- Nylon top with mesh bottom
- Holds 20 basketballs or 30 volleyballs
- Non-marring swivel casters
- Folds to only 6" wide for easy storage

**MCVBCARTY** 40"H x 24"W x 24"D **\$159<sup>99</sup>** EA ★



### STANDARD PORTABLE BALL LOCKER

- 1" steel tubing frame
- Holds up to 20 basketballs
- Hinged cover can be locked (lock not included)

**12002100** 43"H x 41"W x 24"D - 35 lbs. **\$429<sup>99</sup>** EA ★



### WALL MOUNTED BALL LOCKERS

- Constructed of 1" black powder coated steel tubing
- Permanently mounts to your gym wall (hardware not included)
- Holds 6 basketballs; Double model holds 16 basketballs or 30 volleyballs
- Double model includes locking bars at the top and bottom to secure balls (locks sold separately)

**1173123** 66"H x 15"W x 12"D **\$303<sup>99</sup>** EA ★  
**1162578** 66"H x 37"W x 12"D **\$352<sup>99</sup>** EA ★



### 50 BALL CART

- Constructed of 1" O.D. black powder coated steel tubing
- Heavy duty urethane swivel wheels - 2 with brakes
- 5 welded shelves make for easy assembly
- Will hold 50 official size basketballs
- Fits through standard doorways

**1378673** 64"H x 24"W x 61"L - 61 lbs. **\$499<sup>99</sup>** EA ★



### COMPACT BALL LOCKER

- Constructed of 1" powder coated steel tubing
- Holds up to 30 inflated balls
- Can be padlocked (lock not included)
- Larger rear wheels roll smoothly over rough terrain
- Includes mesh ball bag

**1362605** 46"H x 26"W x 28"D - 42 lbs. **\$289<sup>99</sup>** EA ★



### ALL-TERRAIN BALL LOCKER

- 7/8" steel tubing frame w/ red powder coated finish
- Durable, welded wire mesh body
- Can be padlocked (lock not included)
- Heavy duty, 16" poly spoked wheels on rear
- 4" swivel casters on front
- Holds 15 official basketballs or 25 volleyballs

**2 Year Limited Warranty**  
**1342758** 38"H x 46"W x 30"D - 50 lbs. **\$613<sup>99</sup>** EA ★



### DELUXE PORTABLE BALL LOCKER

- Constructed of 3/4" powder coated steel tubing
- Lockable, hinged cover (lock not included)
- Heavy duty multi-directional wheels

**STBALLOC** 40"H x 40"W x 26"D - 50 lbs. **\$489<sup>99</sup>** EA ★ 



### MONSTER BALL LOCKER

- Constructed of 1" powder coated steel tubing
- Holds 30 official basketballs or 40 volleyballs
- Features over sized 4" wheels for easy movement
- The top is lockable (lock not included) and contains special hinges and safety chains to prevent top from falling over

**1162622** 37"H x 47"W x 24"D - 75 lbs. **\$669<sup>99</sup>** EA ★



### BATTING PRACTICE BALL CART

- Constructed of 1.5" O.D. powder coated steel
- Large capacity basket
- Oversized "no flat" tires

<b>1378683</b>	Batting Practice Ball Cart	\$389 <sup>99</sup> EA ★
<b>1375102</b>	Replacement Wheel	\$42 <sup>99</sup> EA ★



### DELUXE TEACHING CART

- Powder coated steel frame, vinyl coated basket with foam grip
- Rubber 4" wheels with sealed ball bearings
- Locking lid that lays flat against the side
- Includes basket hanger and convenient water bottle holder
- Holds 325 tennis balls
- Basket Height - 42 1/2"H
- Top Basket - 19" W x 23"L

<b>1342550</b>		\$449 <sup>99</sup> EA ★
----------------	--	--------------------------



### CONE CART

- Holds (60) 12" pvc or (200) plastic cones
- 1" diameter steel tube frame w/ silver powder coated finish
- 10" semi pneumatic wheels with roller bearings

<b>1362619</b>	45"H x 26"W x 16"D - 30 lbs.	\$236 <sup>99</sup> EA ★
----------------	------------------------------	--------------------------



### LARGE EQUIPMENT CART

- Safe, secure, highly visible wire storage center
- 2" square grid, nickel chrome finish
- Double door opens a full 270° and is lockable
- Comes with (4) 5" polyurethane swivel casters
- Interior shelves sold separately
- Assembly required - 1000 lb. capacity

<b>92448XXX</b>	69"H x 50"W x 26"D	\$1,284 <sup>99</sup> EA	
<b>92449XXX</b>	Shelf 48"W x 24"D	\$119 <sup>99</sup> EA	



### COLOSSAL VOLLEYBALL CART

- Nylon basket includes side pockets for storage
- Holds 40 volleyballs
- Black only

<b>1274417</b>	38"H x 42"W x 32"D	\$264 <sup>99</sup> EA
----------------	--------------------	------------------------



### RACQUET CART

- Galvanized steel construction
- Holds up to 64 tennis rackets or 100 table tennis paddles
- Non-marring casters for easy transport

<b>1690XXX</b>	32"L x 14"W x 28"H	\$129 <sup>99</sup> EA ★
----------------	--------------------	--------------------------



### MULTI-PURPOSE EQUIPMENT WAGON

- All steel construction with pneumatic tires
- Use for carrying equipment, water containers, or field storage
- Front, rear, and side panels fold away for easy loading/unloading
- 1400 lb. weight capacity

<b>1291766</b>	11"H (sides) x 24"W x 48"L	\$499 <sup>99</sup> EA ★
----------------	----------------------------	--------------------------



### SCOOTER BOARD/CONE CART

- 1" diameter, powder coated silver, steel tubing
- Holds up to (28) 12" scooters with or without handles
- Large 10" rubber wheels
- Stores and transports game cones too

<b>1375089</b>	47"H x 32"W x 19"D	\$257 <sup>88</sup> EA ★
----------------	--------------------	--------------------------



### MULTI-PURPOSE EQUIPMENT CART

- Constructed of 1" powder coated steel tubing
- Great for carrying PE and baseball equipment
- Polyester bag measures 24"H x 24"W x 12"D

<b>1197655</b>	46"H x 29"W x 30"D - 29 lbs.	\$471 <sup>99</sup> EA ★
----------------	------------------------------	--------------------------



### BULK STORAGE CART

- Transport most anything in this heavy-duty PVC cart
- Durable plastic bottom board will hold laundry, balls or equipment
- Rolls easily

1366522 17"H x 47"W x 23"D - 47 lbs. \$369<sup>99</sup> EA

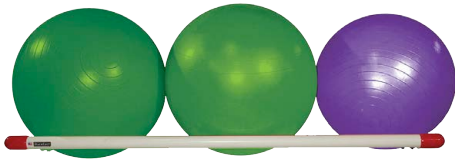

### STABILITY BALL WALL RACK

- Wall-mounted stability ball rack (hardware not included)
- Conveniently holds 3 medium or 2 large fitness balls

1369556 55"W x 18"D - 6 lbs. \$109<sup>99</sup> EA



### SHIELD DELUXE STORAGE BINS WITH LIDS

- Made from high density polyethylene
- 16 gallon bin, holds over 100 lbs
- Use indoors or outdoors
- Stackable design
- Built-in rounded handles and drainage holes
- Great for stations and color-coded activities
- 15.75" W x 18.75" L x 15.5" H
- Color My Class set includes 6 bins and 6 lids in each color; Blue, Green, Orange, Purple, Red and Yellow

**90 Day Limited Warranty**

1453546 \$289<sup>99</sup> SET



### P.E. RECESS CART

- Store and transport equipment and balls frequently used during recess
- Holds up to (30) basketballs, soccer balls, 8.5" playground balls or volleyballs
- Also holds (100) jump ropes and (50) hoops of various sizes

1188318 60"H x 63"W x 19"D \$479<sup>99</sup> EA ★

### STABILITY BALL CART

- Stores and safely transports stability balls with a diameter of 16" or larger, plus jump ropes, exercise bands and resistance tubes
- Lightweight PVC, yet strong, durable and maintenance free
- Roll lock casters secure cart in place with the push of a lever
- Easily passes through a standard doorway

1257557 67"H x 67"W x 19"D \$519<sup>99</sup> EA 



### FITNESS STEP CART

- Large capacity storage rack and transporter for fitness steps and resistance tubes
- Lightweight and durable
- This cart will safely store up to (32) 4" steps or (16) 6" steps plus resistance tubes
- Features include heavy-duty, ball bearing, swivel, non-marring casters with a roll lock feature
- Easily goes through standard doorway

1188332 60"H x 45"W x 19"D \$465<sup>99</sup> EA

### JUMP ROPE/HOOP RACK

- Stores and transports over 120 jump ropes (up to 10' long) plus hoops
- Large base for increased stability
- Bar heights of 56", 62" and 68" allow children and adults to easily access the correct size jump rope
- Easily goes through standard doorway

1188325 68"H x 27"L x 19"D \$319<sup>99</sup> EA



### LARGE LAUNDRY CARTS

- Bag is constructed of heavy duty canvas and removes easily with hook and loop fasteners
- Chrome plated steel frame
- Load capacity: 7 bushels, 51 gallons, 100 lbs.
- Support bars under bag
- 2½" casters, two with brake and 4 caster bumpers
- Outer dimensions: 36½"H x 38½"W x 24¾"D
- Inner dimensions: 23"H x 30½"W x 19½"D
- Assembly required

**Lifetime Warranty**

1. 1378279 Single Compartment \$279<sup>99</sup> EA  
2. 1378280 Divided Compartments \$299<sup>99</sup> EA



### MULTI-TERRAIN ALL PLAY CART

- Large rubber wheels on back
- Non-marring swivel, locking casters on front
- Cart will transport up to (24) soccer balls or basketballs plus jump ropes, hoops and more
- Includes (2) heavy-duty baskets
- Easily goes through standard doorway

1257526 65"H x 52"W x 24"D \$599<sup>99</sup> EA



**STIGA**

**STS185 TABLE**

- 3/4" tournament blue top with silk screen lines
- 2" self opening steel legs
- 2" powder coated, steel apron with ball storage and corner protectors
- 3" mag wheels with sports tread tires, single sided swing arms and 2 locking wheels
- 72" pivoting net and post system with tension adjustments is integrated into the table to allow opening and closing without removing net
- Folds for playback and storage

1375127 \$799.99 EA 



**STIGA**

**STS520 TABLE**

- 1" tournament blue top with silk screen lines
- 2 1/2" self opening, heavy duty steel legs with leg levelers and welded cross brace
- 2 1/2" powder coated, steel apron with full length ball storage and corner protectors
- 5" mag wheels with sports tread tires, single sided swing arms and 2 locking wheels
- 72" premium net and post system with tension adjustment and spring clip mounting
- Features an extra heavy-duty Euro design chassis for unmatched support
- Folds for playback and storage

1375131 \$1,449.99 EA 



**STIGA**

**STIGA® LEGACY INDOOR TABLE TENNIS TABLE**

- 1/2" Black Top
- 1-1/2" Steel Apron
- 1-1/4" Steel Legs
- 2" Double Wheel Casters
- Self-Opening Legs
- Wooden Bottom Board, Cross Brace
- Corner Protection Pads
- Net and Posts Included

1308303 \$429.99 EA 



**TOURNAMENT BALLS**

- Seamless ball for championship play
- 3-star - 40mm - White

1035612 \$2.99 BOX OF 6 ★

**RECREATIONAL BALLS**

- Durable, all around ball
- 1-star - 40mm - White

1035605 \$1.99 BOX OF 6 ★  
1071177 \$44.99 GROSS OF 144 ★

**STIGA DELUXE BALLS**

- Top quality game ball
- 2-star - 40mm - White

918XXXXX \$85.99 GROSS OF 144



**PADDLES**

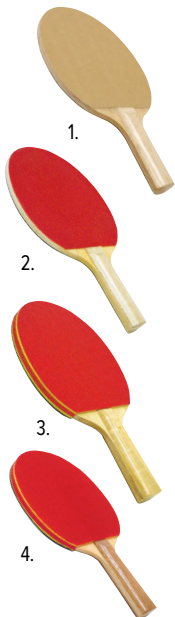

**1. ECONOMY SAND PAPER FACE**

- Sand paper face

NA51XXXX 5 ply \$5.99 EA ★

**2. ECONOMY RUBBER FACE**

- Pips out face

NAR1XXXX 5 ply \$6.99 EA ★

**3. STANDARD SPONGE RUBBER 2MM**

- Pips out face and tapered edging

NAR2XXXX 5 ply \$9.99 EA ★

**4. DELUXE SPONGE RUBBER 2MM**

- Pips in face and tapered edging

NAF2XXXX 5 ply \$11.99 EA ★

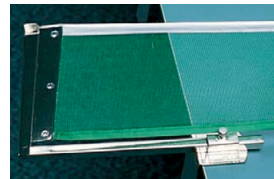

**CHAMPIONSHIP NET AND POST SET**

- Slip on, heavy-duty, open mesh polyethylene net (72" long)
- Heavy-duty posts with extended net clamps

NANP3XXX \$32.99 SET ★



**STIGA**

**PREMIUM CLIPPER & NET POST SET**

- Tournament-level table tennis net and post set
- 72" premium cotton blend net and heavy-duty steel post
- Easy set-up and removal with spring-activated clip
- Precise tension adjustment with height measuring tool for regulation play
- Fits regulation-size tables (60" wide) with up to 1" table thickness

30 Day Limited Warranty

1454852 \$64.99 SET





**GLADIATOR FOOSBALL TABLE**

- Tournament quality table that is built to last
- 15" deep MDF cabinet with 2" thick sidewalls
- 3/4" MDF playing surface
- 4 3/4" square post style legs with levelers
- 5/8" solid steel rods and traditional style men
- 34 3/4"H x 31 1/4"W x 56"L
- Includes 4 balls and integrated cup holders
- Weighs 180 lbs. - assembly required

1375117

\$859<sup>99</sup> EA



**FOOSBALL PLAYERS W/HARDWARE**

- 6 players including attachment hardware
- 90 Day Limited Warranty**
- Color Options: **Black, Red.**

1375152

Specify Color

\$26<sup>99</sup> PACK OF 6



**6 PACK OF FOOSBALLS**

- Replacement foosballs
- 30 Day Limited Warranty**

1378324

\$21<sup>99</sup> PACK

**SHUFFLEBOARD ACCESSORIES**



**SHUFFLEBOARD TABLE WEIGHTS**

- 2" replacement weights
- 90 Day Limited Warranty**
- Color Options: **Blue, Red.**

1379364

Specify Color

\$15<sup>99</sup> EA

**SHUFFLEBOARD TABLE**



**SHUFFLEBOARD TABLE**

- Poly-Coated solid play surface for smooth, fast action
- Play area measures 14"W x 94 3/8"L
- Laminated cabinet and pedestal legs with levelers
- Abacus style scoring
- Includes 8 weights and 1 canister of wax
- Overall size: 31"H x 24 1/4"W x 108 1/4"L

1375124

220 lbs.

\$921<sup>99</sup> EA



**Mizerak**

**DONOVAN 8' POOL TABLE**

- 3/4" playbed
- Reinforced pedestal style legs with leg levelers
- 3 5/8" Black laminate top rails
- Chrome corner posts and caps
- Full profile K66 cushions
- Deep Red wool/nylon blend cloth
- Internal drop pockets
- Includes 2 cues, 1 set of balls, 1 triangle, chalk and table brush
- 31 1/4"H x 55"W x 99"L
- Assembly required

<b>1276497</b>	Slate - 683 lbs.	<b>\$1,766<sup>99</sup></b> EA	
<b>1276503</b>	Slatron - 331 lbs.	<b>\$1,725<sup>99</sup></b> EA	



**Mizerak**

**DAKOTA 8' POOL TABLE**

- 3/4" playbed
- Reinforced pedestal style legs with leg levelers
- 3 5/8" laminate top rails with full profile K66 nose rubber - provide uniform rebound and consistent play
- Wool blend cloth
- Features an internal ball return system
- Includes 2 cues, 1 set of balls, 1 triangle, chalk and table brush
- 31 1/4"H x 55"W x 99"L
- Assembly required

<b>1375150</b>	Slate - 683 lbs.	<b>\$2,171<sup>99</sup></b> EA	
<b>1375151</b>	Slatron - 331 lbs.	<b>\$1,645<sup>99</sup></b> EA	



**CLASSIC BUMPER POOL TABLE**

- 49 1/2" x 33 1/2" play field
- 5 1/8" square legs
- 5 7/8" top apron and 7 3/4" bottom apron
- Constructed of MDF with wood grain laminate
- Accessories Included: 1 set of bumper pool balls, 2 (48") cues, chalk and brush
- Overall Dimensions: 32"H x 41 1/2"W x 57 1/2"L
- Assembly required

<b>1375121</b>	274 lbs.	<b>\$941<sup>99</sup></b> EA	
----------------	----------	------------------------------	--



**SOLID WOOD ONE-PIECE CUES**

<b>NAQ481XX</b>	48"	<b>\$24<sup>99</sup></b> EA ★
<b>NAQ521XX</b>	52"	<b>\$26<sup>99</sup></b> EA ★

Size: 17 oz, 19 oz, 20 oz, 21 oz.

<b>NAQ57117</b>	57" - Specify Weight	<b>\$21<sup>99</sup></b> EA ★
-----------------	----------------------	-------------------------------

**Screw-In Pool Cue Tips**

• For wood and aluminum cues

<b>NASCRTIP</b>	<b>\$13<sup>99</sup></b> DZN ★
-----------------	--------------------------------



**CHALK**

<b>NACHK122</b>	<b>\$9<sup>99</sup></b> BOX OF 12 ★
<b>NACHK144</b>	<b>\$59<sup>99</sup></b> BOX OF 144 ★



**Mizerak**

**MIZERAK SPIDER BRIDGE HEAD**

- Provides 9 different shooting positions
- Slips onto any cue to convert to bridge cue
- Cues sold separately

**90 Day Limited Warranty**

<b>1393111</b>	<b>\$19<sup>99</sup></b> EA
----------------	-----------------------------



## SPIKEBALL™

- Standard set includes one frame and three balls
- Rookie set includes one frame and one ball
- Rookie frame is 50% larger than standard frame
- Standard ball - 3.5" diameter, Rookie ball - 7" diameter

**90 Day Limited Warranty**

<b>1376884</b>	Standard Set	<b>\$74<sup>99</sup></b> SET
<b>1376885</b>	2 Balls - standard size	<b>\$10<sup>99</sup></b> SET
<b>1453529</b>	Rookie Set	<b>\$64<sup>99</sup></b> EA



## BAGGO BEAN BAG TOSS GAME

- Played similar to horseshoes
- Weighs only 20 lbs. and folds making it easy to carry and store (2 1/2"H x 20"W x 36"L)
- Constructed of high-impact polyethylene for lasting durability
- Take the two boards, spread them apart and begin to play
- Includes 2 game boards, eight 6" bean bags, a distance regulator, wall mounting bracket, and instruction booklet

<b>1269000</b>		<b>\$152<sup>99</sup></b> SET
<b>1269017</b>	Replacement Bean Bags - 4 Red + 4 Blue	<b>\$31<sup>99</sup></b> SET OF 8



## MORE BOARD GAMES TO CHOOSE FROM

GAME EDITIONS AND VERSIONS MAY VARY FROM THOSE SHOWN

### STANDARD PLAYING CARDS

- Plastic coated, linen finish
- Packed per dozen
- Half Blue and half Red

<b>NAPC-1XX</b>	Poker	<b>\$35<sup>99</sup></b> DZN ★
-----------------	-------	--------------------------------



### SCRABBLE

- Classic crossword game
- For 2 to 4 players ages 8 and up

<b>4044XXXX</b>		<b>\$36<sup>99</sup></b> EA
-----------------	--	-----------------------------



### UNO CARD GAME

- Yell UNO! when you have only one card left
- America's #1 card game
- Includes 108 cards
- 2 to 10 players ages 7 and up

<b>4036XXXX</b>		<b>\$13<sup>99</sup></b> EA
-----------------	--	-----------------------------



### YAHTZEE

- Throw the dice to build straights, full houses, 5 of a kind - Yahtzee
- For 1 or more players ages 8 and up

<b>4024XXXX</b>		<b>\$21<sup>99</sup></b> EA
<b>4025XXXX</b>	80 Replacement Score Cards	<b>\$8<sup>99</sup></b> EA



### CHESS SET

- 15" x 15" folding board
- (32) plastic chess pieces

<b>2261XXXX</b>		<b>\$10<sup>99</sup></b> SET
-----------------	--	------------------------------

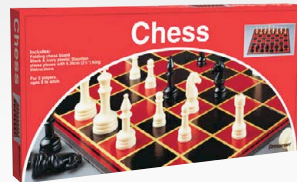

### CHECKERS SET

- 15" x 15" folding board
- (24) 1 1/4" checkers

<b>NA637XXX</b>		<b>\$9<sup>99</sup></b> EA
-----------------	--	----------------------------

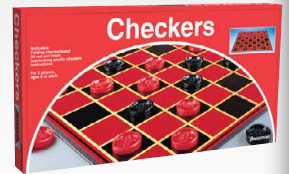

<b>DOMINOES SET WITH CASE</b>	<b>1238211</b>	<b>\$18<sup>99</sup></b> EA
-------------------------------	----------------	-----------------------------

<b>GAME OF LIFE</b>	<b>4011XXXX</b>	<b>\$39<sup>99</sup></b> EA
---------------------	-----------------	-----------------------------

<b>MONOPOLY JUNIOR</b>	<b>4919XXXX</b>	<b>\$34<sup>99</sup></b> EA
------------------------	-----------------	-----------------------------

<b>ROOK</b>	<b>4714XXXX</b>	<b>\$12<sup>99</sup></b> EA
-------------	-----------------	-----------------------------

<b>SCRABBLE DICTIONARY</b>	<b>4915XXXX</b>	<b>\$16<sup>99</sup></b> EA
----------------------------	-----------------	-----------------------------



# BEST SELLER *Voit*



**2-PLY PLAYGROUND BALLS!**

**PLAYGROUND BALLS**

- The most widely used playground ball in the country!
- Please specify color where applicable

<b>VPG5HXXX</b>	5"	Red Only	\$5 <sup>49</sup> EA ★
<b>VPG6HXXX</b>	6"	Blue, Green, Orange, Purple, Red, Yellow	\$5 <sup>59</sup> EA ★
<b>VPG7HXXX</b>	7"	Red Only	\$5 <sup>89</sup> EA ★
<b>VPG85HXX</b>	8 1/2"	Blue, Green, Orange, Purple, Red, Yellow	\$6 <sup>49</sup> EA ★
<b>VPG10HXX</b>	10"	Blue, Green, Orange, Purple, Red, Yellow	\$7 <sup>39</sup> EA ★
<b>VPG13HXX</b>	13"	Red Only	\$15 <sup>99</sup> EA ★
<b>VPG16HXX</b>	16"	Red Only	\$19 <sup>99</sup> EA ★

**PLAYGROUND BALLS**

- The most widely used playground ball in the country
- 2-ply rubber ball for all low impact activities

<b>1369484</b>	6" - Color My Class	\$34 <sup>99</sup> SET OF 6 ★
<b>1033472</b>	8 1/2" - Color My Class	\$41 <sup>99</sup> SET OF 6 ★
<b>1369485</b>	10" - Color My Class	\$45 <sup>99</sup> SET OF 6 ★



# *Voit*

## 8 1/2" ENDURO SERIES PLAYGROUND BALLS

- Our toughest most durable playground ball!
- Nylon wound for more durability and shape retention
- Designed to withstand all high-impact playground activities

Color Options: **Blue, Green, Orange, Purple, Red, Yellow.**

<b>154470</b>	Specify Color	\$8 <sup>99</sup> EA ★
<b>1369483</b>	Color My Class	\$49 <sup>99</sup> SET OF 6 ★



## OFFICIAL KICKBALL

- Official game ball of the World Adult Kickball Association
- Premium rubber cover (latex free)
- Classic red design with a diamond pattern
- Minimum of 5 balls per order

<b>1387040</b>	10" Diameter	\$13 <sup>99</sup> EA
----------------	--------------	-----------------------



# *Voit*

## THE RAINBOW 48 PACK

- Pack includes forty eight 8 1/2" playground balls
- 8 each Blue, Green, Orange, Purple, Red and Yellow

<b>1233179</b>	\$281 <sup>99</sup> PACK OF 48 ★
----------------	----------------------------------



## SIX-COLOR STARTER SET

Package includes: One Blue, Green, Orange, Purple, Red and Yellow of each item.

- Junior footballs
- Junior basketballs
- Size 4 soccer balls
- Official volleyballs
- 8 1/2" playground balls
- 6" color cones
- Mesh bags

<b>99916XXX</b>	42 Pieces	\$446 <sup>99</sup> PACK ★
-----------------	-----------	----------------------------



## HAVE A BALL VALUE PACK

Package includes:

- 12 VOIT® 8 1/2" colored playground balls
- 6 VOIT® Enduro CB2 official basketballs
- 6 MacGregor® size 5 rubber soccer balls
- 2 VOIT® Soft Shot rubber volleyballs
- 2 VOIT® CF9 senior size footballs

<b>999912XX</b>	28 Pieces	\$280 <sup>99</sup> SET ★
-----------------	-----------	---------------------------

# *MacGregor*

## MULTICOLOR BASKETBALLS

- Durable rubber construction
- Deep channels and enhanced pebbling
- Indoor/Outdoor use
- Official size 29.5", Intermediate size 28.5", Junior 27.5", Colt 25.5", Mini 22"

Color Options: **Blue, Green, Orange, Purple, Red, Yellow.**

<b>936021</b>	Official Size	\$16 <sup>99</sup> EA ★
<b>93600</b>	Official - Color My Class	\$79 <sup>99</sup> PACK OF 6 ★
<b>935021</b>	Intermediate Size	\$15 <sup>99</sup> EA ★
<b>93500</b>	Intermediate - Color My Class	\$76 <sup>99</sup> PACK OF 6 ★
<b>934021</b>	Junior Size	\$15 <sup>99</sup> EA ★
<b>93400</b>	Junior - Color My Class	\$73 <sup>99</sup> PACK OF 6 ★
<b>1308099</b>	Colt - Color My Class	\$61 <sup>99</sup> PACK OF 6 ★
<b>1268935</b>	Mini - Color My Class	\$65 <sup>99</sup> PACK OF 6 ★

# *MacGregor*

## MULTICOLOR SOCCERBALLS

- Top quality rubber construction
- Nylon windings and butyl bladder for superior strength and air-retention

<b>94500</b>	Size 5 - Color My Class	\$68 <sup>99</sup> PACK OF 6 ★
<b>MCSBR502</b>	Size 5 - Blue	\$15 <sup>99</sup> EA ★
<b>94400</b>	Size 4 - Color My Class	\$59 <sup>99</sup> PACK OF 6 ★
<b>MCSBR402</b>	Size 4 - Blue	\$15 <sup>99</sup> EA ★
<b>94300</b>	Size 3 - Color My Class	\$56 <sup>99</sup> PACK OF 6 ★

# *MacGregor*

## MULTICOLOR FOOTBALLS

- Durable rubber construction
- Pebble grain exterior with raised laces for a superior grip
- Nylon windings and butyl bladder provides added strength and air-retention

<b>95900</b>	Official - Color My Class	\$76 <sup>99</sup> PACK OF 6 ★
<b>MCX2L25X</b>	Official - Yellow	\$14 <sup>99</sup> EA ★
<b>95700</b>	Youth - Color My Class	\$73 <sup>99</sup> PACK OF 6 ★
<b>95600</b>	Junior - Color My Class	\$71 <sup>99</sup> PACK OF 6 ★
<b>MCX2J25X</b>	Junior - Yellow	\$13 <sup>99</sup> EA ★



### TUFF FOAM BALL PACKAGE

Package includes:

- 6 Voit 8 1/4" "Special" Tuff balls
- 6 Voit 6 1/4" "Softi" Tuff balls
- 6 Voit 5" Mini Tuff balls
- 3 Voit 6 1/4" Tuff dodgeballs
- 3 Voit Tuff soccerballs - size 4

**1179378** 24 Pieces **\$419.99** SET ★



# Voit



**SOFT-LOW BOUNCE TUFF BALLS**

- Our coated foam balls are soft, squeezable and built to last
- Durable enough for all playground and indoor games
- Builds confidence and enhances skill development
- Easy to catch, grip and control
- Tear-resistant cover is washable, non-toxic and can be disinfected

Color Options: **Blue, Green, Orange, Purple, Red, Yellow.**

<b>44075</b>	5" Mini Playball	<b>\$16.99</b> EA ★
<b>1181555</b>	5" - Color My Class	<b>\$79.99</b> SET OF 6 ★
<b>440011</b>	6 1/4" Softi	<b>\$18.99</b> EA ★
<b>1179286</b>	6 1/4" - Color My Class	<b>\$84.99</b> SET OF 6 ★
<b>1369513</b>	7" Seven	<b>\$24.99</b> EA ★
<b>1369579</b>	7" - Color My Class	<b>\$115.99</b> SET OF 6 ★
<b>440101</b>	8 1/4" Special	<b>\$35.99</b> EA ★
<b>1236149</b>	8 1/4" - Color My Class	<b>\$175.99</b> SET OF 6 ★



## Voit

### BOUNCEE FOAM BALLS

- High density coated foam balls are lively and bounce
- Use for teaching dribbling, kicking and bouncing lead up skills
- Tear-resistant cover is washable, non-toxic and can easily be disinfected
- Color My Class set includes one of each color: Blue, Green, Orange, Purple, Red and Yellow

<b>1395254</b>	6 1/4"	<b>\$99.99</b> SET OF 6 ★
<b>1395255</b>	8 1/4"	<b>\$199.99</b> SET OF 6 ★



## Voit

### 6 1/4" NEON "SOFTI" TUFF BALLS

- Soft, squeezable coated foam balls in exciting bright colors
- Soft enough for indoor play and "tuff" enough for rugged playground activities
- Easy to catch, grip and control

**1274967** **\$104.99** SET OF 6 ★



## Voit

### TUFF COATED FOAM FOOTBALLS

- Lightweight, yet heavy enough for quality football action
- Color Options: **Blue, Green, Orange, Purple, Red, Yellow.**

<b>VFTBL10</b>	Junior - 9 3/4"	<b>\$28.99</b> EA ★
<b>1243925</b>	Junior - Color My Class	<b>\$142.99</b> SET OF 6 ★
<b>VTMNF891</b>	Mini - 8 1/2"	<b>\$27.99</b> EA ★
<b>1243864</b>	Mini - Color My Class	<b>\$119.99</b> SET OF 6 ★



## Voit

### TUFF COATED FOAM SOCCER BALL

- Durable ball, perfect to learn lead-up skills
  - Features high-density foam covered in "tuff" vinyl
- Color Options: **Blue, Green, Orange, Purple, Red, Yellow.**

<b>44017XXX</b>	Size 4	<b>\$36.99</b> EA ★
<b>1243987</b>	Size 4 - Color My Class	<b>\$164.99</b> SET OF 6 ★
<b>1369585</b>	Size 5	<b>\$39.99</b> EA ★
<b>1369584</b>	Size 5 - Color My Class	<b>\$173.99</b> SET OF 6 ★



## Voit

### TUFF 6 1/4" DODGEBALL

- Soft, slow moving and easy to grip
- Soft, low density foam covered in a "Tuff" outer cover

<b>44020</b>	Black	<b>\$19.99</b> EA ★
<b>1369507</b>	Color My Class	<b>\$99.99</b> SET OF 6 ★

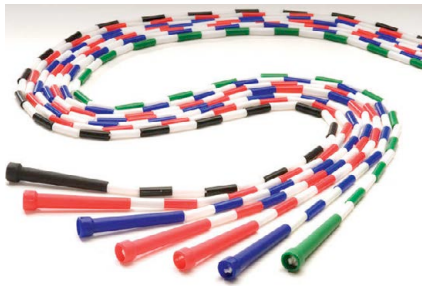

### SEGMENTED SKIP ROPES

- Designed for use by all age groups and skill levels
- An economical way to promote mass participation
- Great for a fun, aerobic workout
- Features durable, plastic segments over a solid long-lasting nylon cord

<b>1040142</b>	6' Black/White	\$4 <sup>99</sup> EA ★
<b>1040159</b>	7' Red/White	\$3 <sup>99</sup> EA ★
<b>1040166</b>	8' Blue/White	\$4 <sup>99</sup> EA ★
<b>1040173</b>	9' Red/White/Blue	\$5 <sup>99</sup> EA ★
<b>1040128</b>	10' Red/White	\$6 <sup>99</sup> EA ★
<b>1040135</b>	16' Green/White	\$6 <sup>99</sup> EA ★



### SPEED ROPES

- Poly rope with plastic swivel handle
- Speed, durability, and flexibility all in one rope

<b>1040043</b>	6'	\$4 <sup>25</sup> EA ★
<b>1040050</b>	7'	\$4 <sup>99</sup> EA ★
<b>1040067</b>	8'	\$5 <sup>99</sup> EA ★
<b>1040074</b>	9'	\$5 <sup>99</sup> EA ★
<b>1040081</b>	10'	\$5 <sup>99</sup> EA ★
<b>1040098</b>	16'	\$6 <sup>99</sup> EA ★



### LICORICE ROPES

- Perfect for beginners or experienced jumpers who want the best
- Great for speed jumping and a favorite with jump teams
- Injection molded handles designed for comfort and free spin
- Durable, plastic rope

<b>17206XXX</b>	Black 6' Licorice	\$3 <sup>99</sup> EA
<b>17207XXX</b>	Orange 7' Licorice	\$5 <sup>99</sup> EA
<b>17208XXX</b>	Red 8' Licorice	\$5 <sup>99</sup> EA
<b>17209XXX</b>	Green 9' Licorice	\$5 <sup>99</sup> EA
<b>17210XXX</b>	Black 10' Licorice	\$6 <sup>99</sup> EA



### LOW PROFILE CONES

- Soft, flexible and stack easily
- Color code your drills for more effective practice time
- Available in Orange, Yellow, or Color My Class
- 3"H x 7 3/4" diameter
- Color My Class set includes 2 of each color: Blue, Green, Orange, Purple, Red and Yellow

<b>1255706</b>	Orange	\$17 <sup>99</sup> DZN ★
<b>1276558</b>	Yellow	\$19 <sup>99</sup> DZN ★
<b>1255690</b>	Color My Class	\$14 <sup>99</sup> DZN ★



### SPOT MARKERS

- 9" diameter, soft, flexible, plastic markers
- Stick to gym floors without shifting
- Color My Class pack includes either 1 or 2 of each color: Blue, Green, Orange, Purple, Red and Yellow

<b>6058SPOT</b>	Color My Class (12)	\$44 <sup>99</sup> DZN ★
<b>1309973</b>	Color My Class (6)	\$23 <sup>99</sup> SET OF 6 ★
<b>6059XXXY</b>	Orange (12)	\$44 <sup>99</sup> DZN ★



### STANDARD HOOPS

- No P.E. or recreation program is complete without hoops
- Versatile hoops teach balance, coordination and rhythm
- Use as targets, jump and hop rings for races and much more
- Each dozen includes 2 of each color: Blue, Green, Orange, Purple, Red and Yellow

<b>1246087</b>	24" Diameter	\$65 <sup>99</sup> DZN
<b>1246070</b>	30" Diameter	\$70 <sup>99</sup> DZN
<b>1274646</b>	36" Diameter	\$75 <sup>99</sup> DZN



### 5" NYLON BEAN BAGS

- Nylon bags are filled with synthetic filler
- Color My Class set includes two of each color

<b>1293418</b>	Color My Class	\$19 <sup>99</sup> DZN ★
----------------	----------------	--------------------------



### ZOOMER SCOOTERZ

- 16" x 16" scooters with safety guards to protect hands and fingers
- Feature large 4", durable all-terrain, ball bearing wheels
- Tough for the playground and safe for gym floors
- Supports up to 175 lbs

<b>1265293</b>	Color My Class	\$399 <sup>99</sup> SET OF 6 ★
<b>1296082</b>	Blue	\$74 <sup>99</sup> EA ★
<b>1389168</b>	Replacement Wheels	\$30 <sup>99</sup> SET OF 4 ★



### TURBOSCOOTER™

- Non-Connecting scooters with safety hand guards
- Oversized 4" wheels for use outdoors and indoors
- Rugged enough to be used on concrete and asphalt

<b>1363648</b>	12" - Color My Class	\$357 <sup>99</sup> SET OF 6
<b>1363649</b>	12" Blue	\$64 <sup>99</sup> EA
<b>1137408</b>	16" - Color My Class	\$419 <sup>99</sup> SET OF 6
<b>1363650</b>	16" Yellow	\$77 <sup>99</sup> EA
<b>1390055</b>	Replacement Wheels	\$43 <sup>99</sup> SET OF 4

### DELUXE HOOPS

- Stronger than our standard hoops - thicker wall
- Set them up as targets for tossing, jump and hop rings for races or in your obstacle course
- Set of 12 includes 2 of each color: Blue, Green, Orange, Purple, Red and Yellow

<b>1064902</b>	24" Diameter	\$82 <sup>99</sup> DZN
<b>1064919</b>	30" Diameter	\$87 <sup>99</sup> DZN
<b>1064926</b>	36" Diameter	\$92 <sup>99</sup> DZN

### PREMIUM NO-KINK® HOOPS

- Regular hoops often become the object of tug-of-war
- Pulling causes a kink, and off to the hoop graveyard!
- Extra thick walls prevent kinking
- Includes 2 of each color: Blue, Green, Orange, Purple, Red and Yellow

<b>02150XXX</b>	24" Diameter	\$94 <sup>99</sup> DZN
<b>02160XXX</b>	30" Diameter	\$99 <sup>99</sup> DZN
<b>02170XXX</b>	36" Diameter	\$104 <sup>99</sup> DZN



### SPIKEBALL™

- Standard set includes one frame and three balls
- Rookie set includes one frame and one ball
- Rookie frame is 50% larger than standard frame
- Standard ball - 3.5" diameter, Rookie ball - 7" diameter

#### 90 Day Limited Warranty

<b>1376884</b>	Standard Set	\$74 <sup>99</sup> SET
<b>1376885</b>	2 Balls - standard size	\$10 <sup>99</sup> SET
<b>1453529</b>	Rookie Set	\$64 <sup>99</sup> EA



### NEW! CROSSNET

- CROSSNET Volleyball, CROSSNET H2O, CROSSNET Soccer, Portable 4 square, and doubles net
- Volleyball Height adjustable for men (7'11"), women (7'4") & children (5'6")
- Easy setup and break down

<b>1461854</b>	CROSSNET Volleyball	\$149 <sup>99</sup> EA
<b>1461856</b>	CROSSNET Dbls Net	\$74 <sup>99</sup> EA
<b>1461855</b>	CROSSNET H2O	\$129 <sup>99</sup> EA
<b>1461857</b>	CROSSNET Soccer	\$149 <sup>99</sup> EA
<b>1461858</b>	CROSSNET Portable 4 Square	\$49 <sup>99</sup> EA



### FLOORMARX™ SET

- Safe, smart, and easy way to instruct movement
- Quick to apply and easy to remove
- Fast drying ink (2min) and cleaning wipes (30 sec) pass safety slip tests
- One Floor Marker writes for over 250 yards (over 4 rolls of traditional floor tape)
- Set includes 2 Floor markers, 1 green and 1 blue, and 1 canister cleaning foot wipes
- Intended for sealed gymnasiums and dance floors, and other non-porous surfaces
- BEFORE FULL APPLICATION, always test on multiple, small, inconspicuous areas of the floor

<b>1454864</b>	\$45 <sup>99</sup> SET
----------------	------------------------



### NEW!

#### FLOORMARX H2O PERF. PACK

- Pack includes 5 markers (red, orange, green, blue, and purple), 1 canister of foot wipes, and 1 bag of R&R Foot Towels (20)

<b>1461860</b>	\$84 <sup>99</sup> PACK
----------------	-------------------------



### ORANGE GAME CONES

- Flexible PVC with weighted base for added stability
- Stack easily for storage

<b>1040814</b>	12"	\$16 <sup>99</sup> EA ★
<b>1040838</b>	18"	\$19 <sup>99</sup> EA ★
<b>1040845</b>	28"	\$39 <sup>99</sup> EA
<b>1040852</b>	36"	\$51 <sup>99</sup> EA
<b>1040852SET</b>	36"	\$249 <sup>99</sup> SET OF 5

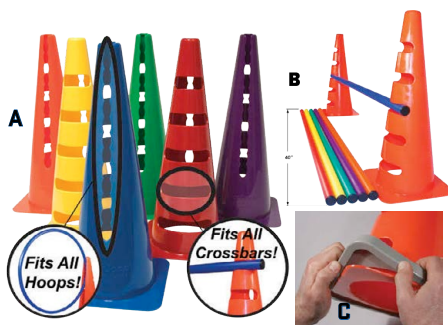

### SLOTCONES™

- Optional slip on rubber bases adds more stability and lock-in crossbars pop in snugly creating hurdles of various heights
- Lock-In Crossbars and Weighted Bases sold separately
- SlotCones and crossbars include one of each color: Blue, Green, Orange, Purple, Red and Yellow

<b>1453543</b>	SlotCones	\$61 <sup>99</sup> SET OF 6
<b>1453544</b>	Lock-In Crossbars	\$46 <sup>99</sup> SET OF 6
<b>1454870</b>	Weighted Rubber Base	\$10 <sup>99</sup> EA



### GAME CONES

- Flexible, PVC cones with weighted bases for increased stability
- Use to designate boundaries, lanes and teams

<b>1398265</b>	28" - Color My Class	\$159 <sup>99</sup> SET OF 6
<b>1245875</b>	18" - Color My Class	\$94 <sup>99</sup> SET OF 6 ★
<b>1093452</b>	12" - Color My Class	\$59 <sup>99</sup> SET OF 6 ★
<b>MS6CONPK</b>	6" - Color My Class	\$34 <sup>99</sup> SET OF 6 ★



### OUTDOOR TETHERBALL POLE

- 12'L (2 pieces 6'L) 2 3/8" galvanized steel post installs permanently into the ground 2'
- Permanent top eye and ball included

**THBIG** \$299<sup>99</sup> EA ★



### DISC GOLF DISCATCHER®

- Galvanized steel construction with HD welds
- 28 chain grid design
- Powder coated stainless steel chain rack with vinyl numbers
- Anti-skip basket rim prevents skips
- PDGA approved

<b>MDCI</b>	In-Ground/Permanent	\$699 <sup>99</sup> EA
<b>MDCP</b>	Portable w/Base	\$699 <sup>99</sup> EA



1.

2.

### TETHERBALLS

- Both balls feature nylon windings and a butyl bladder for added shape and air retention
- Choose between a soft touch cover for added comfort or a traditional rubber cover
- Includes an attached recessed rope

<b>1. VCT850HS</b>	Soft Touch Cover	\$22 <sup>99</sup> EA ★
<b>2. VCT850HX</b>	Rubber Cover	\$18 <sup>99</sup> EA ★



### 6" SLASH-PROOF SWING SEAT

- Synthetic rubber seat with a metal insert for increased durability
- For ages 5-12

**6152DXXX** \$65<sup>99</sup> EA ★



### ULTIMATE FRISBEE® DISC

- Meets the specifications for the sport of Ultimate
- UPA approved - 175 grams and 10 1/2" diameter
- Colors and graphics may vary

**30 Day Limited Warranty**

**1268942** \$15<sup>99</sup> EA



### WHAM-O® FRISBEE® DISC

- The original Frisbee®
- 3 weights and diameters to choose from
- Color and graphics may vary

<b>1308822</b>	10 1/4" Diameter - 160 Grams	\$14 <sup>99</sup> EA
<b>1308839</b>	11" Diameter - 200 Grams	\$15 <sup>99</sup> EA

### ORIGINAL PILLO POLO® GAME

#### HOW THE GAME IS PLAYED:

- Played similar to ice hockey rules, except the goalie is allowed to pick up the ball and throw it down field
- No. Players: 12 plus substitutes
- Age Levels: 7 years and up
- Space Required: 50' x 100'
- Supervision Required: 1 Referee
- Average Activity Time: 30 - 60 min.
- Sticks are lightweight yet durable - tough outer skin over urethane foam heads that resist peeling and flexible plastic shafts

HIGH PERFORMANCE STICKS.  
MADE OF SOFT DURABLE FOAM!



### COMPLETE PILLO POLO® GAME

- 6 Blue and 6 Yellow sticks 31" long, two 7" foam balls, set of official rules
- Goals, cones and bag not included

**1041170** \$194<sup>99</sup> SET ★



### ACCESSORIES

#### EXTRA PILLO POLO® STICKS

Replacement sticks to go with Pillo Polo® game (1041170).

Color Options: **Yellow, Blue.**

**601XXXXX** Extra Pillo Polo® Sticks \$23<sup>99</sup> EA ★

#### 6" GAME CONES

Color Options: **Blue, Orange, Purple, Red, Yellow, Green.**

**MS6CONPK** \$34<sup>99</sup> SET OF 6 ★

#### STORAGE BAG

Color Options: **Black, Blue, Gold, Kelly, Orange, Purple, Red.**

**SNBCNET** \$17<sup>99</sup> EA ★

#### EXTRA 7" FOAM BALL

**607XXXXXY** \$17<sup>99</sup> EA ★

#### PILLO POLO GOAL

• 44"H x 54"W x 30"D steel goal

**1343113** \$124<sup>99</sup> EA



### 3.0 TOURNAMENT NET & FRAME

- Portable, regulation-size pickleball 3.0 Tournament Net
- Comes with a high-strength 22' steel snap-together frame, lightweight net and instructions on how to set-up and play, all in a sturdy carry bag

90 Day Limited Warranty

1450232 \$229<sup>99</sup> EA



### 3.0 TOURNAMENT NET & FRAME SET WITH DILLER WOOD PADDLES

- This tournament set includes everything you need to get started playing pickleball
- Includes portable, regulation-size metal frame, net, 4 Diller paddles, 4 pickleballs, nylon carrying bag and rules/strategy guide

90 Day Limited Warranty

1364661 \$299<sup>99</sup> SET



### DILLER PADDLE & BALL PACK

- The Ultimate Starter Kits!
- Durable maple wood pickleball paddles with wrapped grip, safety strap and pickleballs

1450226 2 Paddles + 4 Balls \$32<sup>99</sup> PACK  
1450227 4 Paddles + 4 Balls \$55<sup>99</sup> PACK

### DILLER PADDLE

- Lightweight 7-ply maple wood paddle with wrapped handle and safety wrist strap
- From the company that invented the game
- A top choice for recreational and institutional play

1450225 \$19<sup>99</sup> EA



### 47" ALUMINATOR® HOCKEY SET

- Strong aluminum shafts and reinforced plastic blades
- Great grip improves stick handling
- Includes: 12 sticks, 2 hotballs, 2 soft shot pucks, 2 replacement blades and instructions

10577XXX	47" Stick Set	\$351 <sup>99</sup> SET
8853	Replacement 47" Aluminum Stick, Red or Blue	\$36 <sup>99</sup> EA
894	Replacement Blades Red or Blue Set of 3	\$18 <sup>99</sup> SET OF 3
20026517	40" Goalie Stick, Aluminum Shaft	\$30 <sup>99</sup> EA



### HOCKEY GOAL - STEEL

- 4' x 6' goal to be used indoors or outdoors for soccer, hockey, floor hockey or many other uses
- 3mm net with nylon sleeves
- 1 5/8" O.D. galvanized steel tubing and assembled with galvanized steel fittings; equipped rubber footings for indoor use
- Weight: 44 lbs.

1298857 4'H x 6'W x 18"D \$532<sup>99</sup> EA ★  
1162400 Replacement Net \$77<sup>99</sup> EA ★



### HOCKEY GOAL - ABS

- 4' x 6' goal to be used indoors or outdoors for soccer, hockey, floor hockey or many other uses.
- 3mm net with nylon sleeves
- 1 5/8" O.D. Sportstuff rods and assembled with ABS fittings
- Weight: 18 lbs.

1249088 4'H x 6'W x 18"D \$243<sup>99</sup> EA ★  
1162400 Replacement Net \$77<sup>99</sup> EA ★



### LIFETIME GUARANTEE ON SHAFTS!



### LTG 50" HIGH SCHOOL/COLLEGIATE HOCKEY SETS

- LTG shafts guaranteed for life!
- Tough, black, plastic shaft with a lightweight, solid, fiberglass, rod
- Set includes: 10 LTG sticks, 2 ABS goalie sticks, 2 speed control balls and instructions
- Indoor sticks have red and blue blades
- Outdoor sticks have black and white blades
- Made in the USA

1304213	Indoor Set	\$251 <sup>99</sup> SET
1304220	Outdoor Set	\$271 <sup>99</sup> SET



CROSS SECTION



### E-Z TARGET

- Finally a good quality, economical foam target for institutional use
- 36" square and 3 1/2" thick
- Comes complete with stand and paper target face
- Lightweight for easy set up and take down
- For bows up to 40 lbs.

**30 Day Limited Warranty**

**1308563** \$89<sup>99</sup> EA

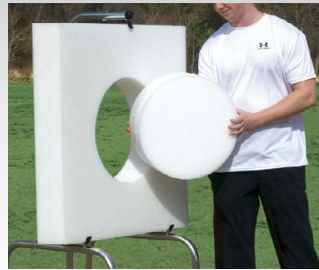

### ETHAFOAM TARGETS WITH REPLACEABLE CORE

- Used at many of the finest camp and school archery programs
- Features an 18" replaceable core
- 6" thick foam is weather/insect proof with self healing tendency
- Target stand sold separately
- Target face included

<b>1375654</b>	36" Square	\$319 <sup>99</sup> EA ★
<b>1375655</b>	36" Round	\$333 <sup>99</sup> EA ★
<b>1375656</b>	48" Square	\$426 <sup>99</sup> EA ★
<b>1375657</b>	48" Round	\$469 <sup>99</sup> EA ★
<b>ARCORE</b>	18" Replacement Cores - Fits 36" and 48"	\$320 <sup>99</sup> SET OF 3 ★



### FREE STANDING ROLLED FOAM TARGET

- Features "Rolled Heat Bond" - foam strips laminated under heat and pressure
- No stand needed because bottom is flat
- 36" tall and 12" thick
- Built-in carry handle
- 4 color hang on face included

**NECAS36** 36" - 30 lbs. \$324<sup>99</sup> EA



### POWERLIGHT TARGET

- High density foam for maximum durability
- Twice the life of normal recreational targets
- Accepts up to 70 lb. draw weight bows
- Easy arrow removal

**1394269** 36" - 35 lbs. \$336<sup>99</sup> EA  
**1394270** 48" - 50 lbs. \$519<sup>99</sup> EA

**CAN BE USED WITH BOWS UP TO 70LBS.**



### FOAM TARGETS

- 100% self-healing foam - 6" thick
- Waterproof, UV resistant and impervious to insects
- Reversible - adds life to your target
- Target face included

**3739XXX** 36" - 12 lbs. \$376<sup>99</sup> EA



### ROLLED FOAM TARGET

- Lighter weight for easy set up and storage
- Features "Rolled Heat Bond" - foam strips laminated under heat and pressure
- Available in 36" and 48" diameters
- Approximately 7" thick
- Target face included

**NECA236X** 36" - 15 lbs. \$256<sup>99</sup> EA  
**NECA248X** 48" - 30 lbs. \$379<sup>99</sup> EA



### TARGET STANDS

- Holds 36" and 48" targets

**3718XXXX** Wheeled Stand \$157<sup>99</sup> EA ★  
**1197761** Tripod Stand \$85<sup>99</sup> EA ★



### MONSTER TARGET STAND

- Adjustable - holds all targets 30" - 50" in diameter
- Constructed using 1 1/3" galvanized steel tubing
- Large wheels allow for easy rolling

**4 Year Limited Warranty**  
**ARTARSTD** \$268<sup>99</sup> EA ★

### ARCHERS' FAVORITE FIBERCLOTH FACES



### ROUND TARGET FACES

- Long lasting, fibercloth material
- Waterproof - skirted

**1282566** 48" - Slip-On \$44<sup>99</sup> EA ★  
**1282580** 36" - Slip-On \$27<sup>99</sup> EA ★

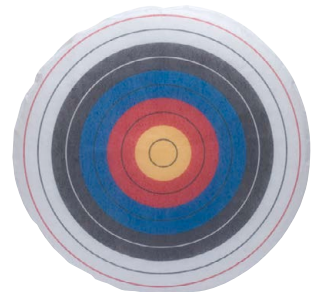

### SQUARE TARGET FACES

- Long lasting, fibercloth material
- Waterproof - no skirt

**1282573** 48" - Flat \$39<sup>99</sup> EA ★  
**1282597** 36" - Flat \$26<sup>99</sup> EA ★

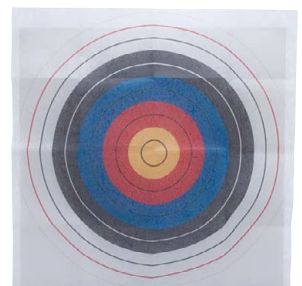

## RECURVE BOWS

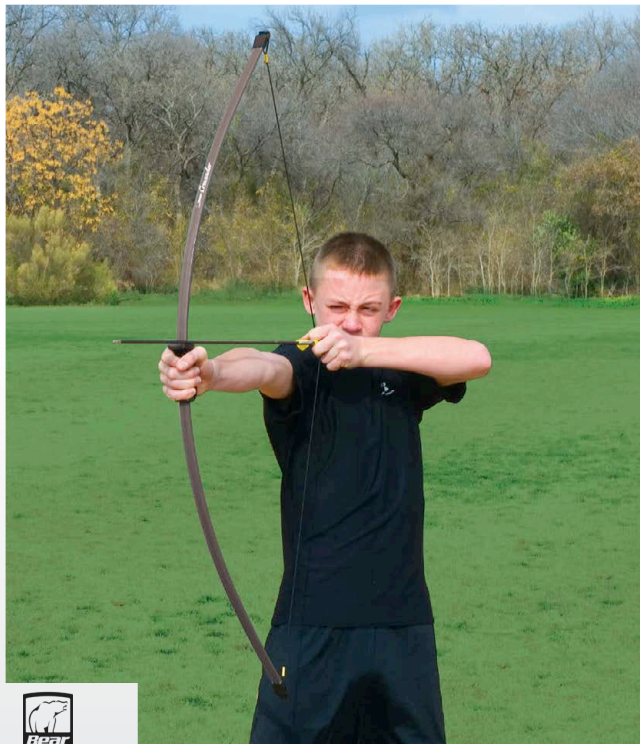

### SOLID RECURVE BOWS

- Uses durable composite limbs with molded plastic handle
- Used nationwide by camp and school programs
- For left or right hand - bow string included

<b>3752XXXX</b>	Bow AMO 44", Draw Wt. 10-18 lbs. (Ages 5 to 10)	<b>\$46<sup>99</sup></b> EA
<b>3678XXXX</b>	Bow AMO 51", Draw Wt. 10-20 lbs. (Ages 9+)	<b>\$65<sup>99</sup></b> EA
<b>3676XXXX</b>	Bow AMO 60", Draw Wt. 30-35 lbs. (Ages 10+)	<b>\$81<sup>99</sup></b> EA



### ARCHERY STARTER KIT

#### PACKAGE INCLUDES:

- (3) foam targets, 36" diameter x 6" thick with 10 ring target face
- (3) tripod target stands
- (3) 60" - 20-29lb. draw youth bows
- (3) 60" - 30-35 lb. draw youth bows
- (72) 28" Safetyglass vaned arrows
- (6) armguards
- (6) shooting gloves (3 medium and 3 large)
- (3) ground quivers
- (1) archery manual
- (1) storage cart designed specifically to store this entire package

1072549

**\$2,399<sup>99</sup>** PACK 



### MULTI-PURPOSE EQUIPMENT CART

- Constructed of 1" powder coated steel tubing
- Great for carrying PE and baseball equipment
- Polyester bag measures 24"H x 24"W x 12"D

1197655

46"H x 29"W x 30"D - 29 lbs.

**\$471<sup>99</sup>** EA ★



## COMPOUND BOWS



### GENESIS BOWS

- Fiberglass and aluminum bow that is easy to shoot
- Combines "zero let-off" with light, adjustable 10-20 lb. draw weights that cover all standard draw lengths
- Official Bow of the National Archery in the Schools Program
- Color Options: **Blue, Green, Orange, Purple, Red, Yellow**
- Hand: **Right, Left.**

1255485

**\$234<sup>99</sup>** EA



### GENESIS MINI BOW

- Same as the Genesis bow - for younger archers
- Weighs only 2 lbs. with adjustable draw weights of 6-12 lbs. to cover draw lengths from 14" - 25"
- Color Options: **Black, Blue, Red**
- Hand: **Right, Left.**

1255591

**\$234<sup>99</sup>** EA



### MONARCH TAKEDOWN BOW

- 62" takedown bow designed for beginners
- Hard wood riser, wood core and fiberglass limbs
- Ready to shoot with arrow rest installed
- Shoots right or left handed
- Available in 20-25-29 lb. draw weights
- Hand: **Left, Right**
- Weight: **20 LB, 25 LB, 29 LB.**

1387750 Specify Hand and Draw Weight **\$153<sup>99</sup>** EA

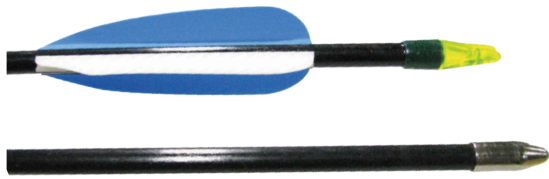

### FIBERGLASS TARGET ARROWS

- Extremely durable, withstands much abuse
  - 3" plastic vanes and steel target point
  - Maximum spine weight 40 lbs.
- Length: 26", 28", 30".

20027506	Dz.	\$63 <sup>99</sup>	DZN
20027572	72 Pack	\$365 <sup>99</sup>	PACK OF 72
20027544	Gross	\$578 <sup>99</sup>	GROSS OF 144
1305067	Nocks 17/64"	\$50 <sup>99</sup>	PACK OF 100
1305074	Points 17/64"	\$6 <sup>99</sup>	DOZEN



### SAFETYGLASS™ TARGET ARROWS

- Strong, durable, fiberglass arrows that flex and will not splinter
- Includes nock, point and vanes
- Spine weight maximum 29 lbs.

8102XXXX	26"	\$524 <sup>99</sup>	PACK OF 72
8114XXXX	Combo 24 Each 26" - 28" - 30"	\$524 <sup>99</sup>	PACK OF 72



### SELECT WOOD ARROWS

These select grade arrows are made from the finest 5/16" wood shafts. Fletched with 3" feathers, snap nock, and lightweight crimp-on target point. Spine weight maximum 35 lbs. Available with cedar shafts or economy poplar wood shafts. Please specify length.

Length: 26", 28", 30".

1160123	Poplar Shafts - Dozen	\$82 <sup>99</sup>	DZN
1160130	Poplar Shafts - Pack of 72	\$441 <sup>99</sup>	PACK OF 72
1162950	Poplar Shafts - Pack of 144	\$756 <sup>99</sup>	GROSS OF 144

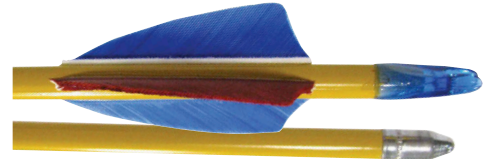

### STANDARD WOOD ARROWS

- Standard grade arrows with 5/16" wood shafts
  - Features PVC vanes, snap-on nock and crimped steel target point
  - Maximum spine weight 35 lbs.
- Length: 24", 26", 28".

3791XXXX	Cedar Shafts - Dozen	\$82 <sup>99</sup>	DZN
3732XXXX	Cedar Shafts - Pack of 72	\$420 <sup>99</sup>	PACK OF 72 ★
3726XXXX	Cedar Shafts - Pack of 144	\$778 <sup>99</sup>	GROSS OF 144
1160109	Poplar Shafts - Dozen	\$70 <sup>99</sup>	DZN
1160116	Poplar Shafts - Pack of 72	\$380 <sup>99</sup>	PACK OF 72
1162943	Poplar Shafts - Pack of 144	\$708 <sup>99</sup>	GROSS OF 144



### ARCHERY CUSTOM NETTING

FOR INDOOR AND OUTDOOR USE!

- Heavy-duty, fine mesh netting for use with bows up to 35 lbs.
- Support nets on guy wires from walls, HD portable standards or in-ground posts - not included
- Netting is bordered with grommets at top and corners
- Specify Size: 10' standard height - Order 10'H x desired length

SNARCHEYDS	\$2 <sup>99</sup>	SQ.FT
------------	-------------------	-------

### PRE-CUT ARCHERY NETTING

1233810DS	16'W x 10'H	\$328 <sup>99</sup>	EA
1233827DS	26'W x 10'H	\$494 <sup>99</sup>	EA
1233834DS	36'W x 10'H	\$696 <sup>99</sup>	EA
1233841DS	50'W x 10'H	\$946 <sup>99</sup>	EA



### 6" ECONOMY ARMGUARD

- Vinyl leatherette with easy fasten hook for youth programs

3700XXXX	\$7 <sup>99</sup>	EA
----------	-------------------	----



### 6" DELUXE ARMGUARD

- Tough vinyl with 2 straps and hook and loop fasteners
- One size fits all - colors may vary

3759XXXX	\$18 <sup>99</sup>	EA
----------	--------------------	----



### 12" DELUXE ARMGUARD

- Tough vinyl with 4 straps and hook and loop fasteners
- One size fits all

3804XXXX	\$21 <sup>99</sup>	EA
----------	--------------------	----



### GROUND QUIVER

- All steel - holds 12 arrows

3764XXXX	\$23 <sup>99</sup>	EA
----------	--------------------	----



**TEAMMLB**<sup>®</sup>

# MLB REPLICAS



**MLB<sup>®</sup> CREW NECK  
COTTON TEE**

NKN199	ADULT	S-3XL
NKNY28	YOUTH	S-XL

**\$19<sup>99</sup>**

ADULT

**\$17<sup>99</sup>**

YOUTH



**MLB<sup>®</sup> CREW NECK  
SYNTHETIC TEE**

NKN223	ADULT	S-3XL
NKNY23	YOUTH	S-XL

**\$26<sup>99</sup>**

ADULT

**\$24<sup>99</sup>**

YOUTH



**MLB<sup>®</sup> 1-BUTTON  
JERSEY**

NKN383	ADULT	S-3XL
NKNY83	YOUTH	S-XL

**\$34<sup>99</sup>**

ADULT

**\$29<sup>99</sup>**

YOUTH



**OC SPORTS**

MAJOR LEAGUE<sup>®</sup> REPLICAS BY OUTDOOR CAP<sup>®</sup>

• Features 3D logo, performance material construction & adjustable tab back

**MLB350Y**  
**MLB350A**

Youth(6 5/8-7 1/4)  
Adult(6 7/8-7 1/2)

**\$11<sup>99</sup>** EA  
**\$11<sup>99</sup>** EA



# **Athletic Connection**

**TEAM SPORTS - STRENGTH & FITNESS - FACILITIES - P.E.**

BASEBALL/SOFTBALL

BASKETBALL

FOOTBALL

HYDRATION

LACROSSE

FIELD HOCKEY

TENNIS

RACQUETBALL

BADMINTON

SOCCER

TRACK & FIELD

VOLLEYBALL

WRESTLING

WEIGHT LIFTING

CARDIO

FLOORING

CORE

SPEED/AGILITY

ASSESSMENT

MATS

GYMNASTICS

BOXING

COACHING

CONCESSIONS

FIELD MARKING

FLOOR COVERS

GAME TABLES

LOCKS & LOCKERS

BENCHES & BLEACHERS

PARKS

SCOREBOARDS

SPORTS MEDICINE

TRAFFIC SAFETY

STORAGE

WALL PADS

PHYSICAL EDUCATION



# *Building Fun Since 1981<sup>SM</sup>*

For three decades, Kraftsman Commercial Playground and Waterparks have enriched communities through affordable, safe play experiences that will last for generations. As innovators, we approach each project with strategic creativity, providing uncompromising quality with the best products and services available. We build engaging, interactive experiences that create economic value, connect the diversity of communities and promote the freedom of self-discovery. From the initial planning to the ribbon cutting ceremony, the team at Kraftsman provides the playground and aquatic products and designs vital to community progress and human development through safe outdoor spaces that enrich the lives of all ages who seek new adventures.

PLAYGROUNDS  
& THEMED PLAY

FITNESS  
& SPORTS

WATER PARKS  
& FOUNTAINS

HARDSCAPES  
& AMENITIES